

Course 2

Modules 1–10

Laser Systems and Applications

2nd Edition

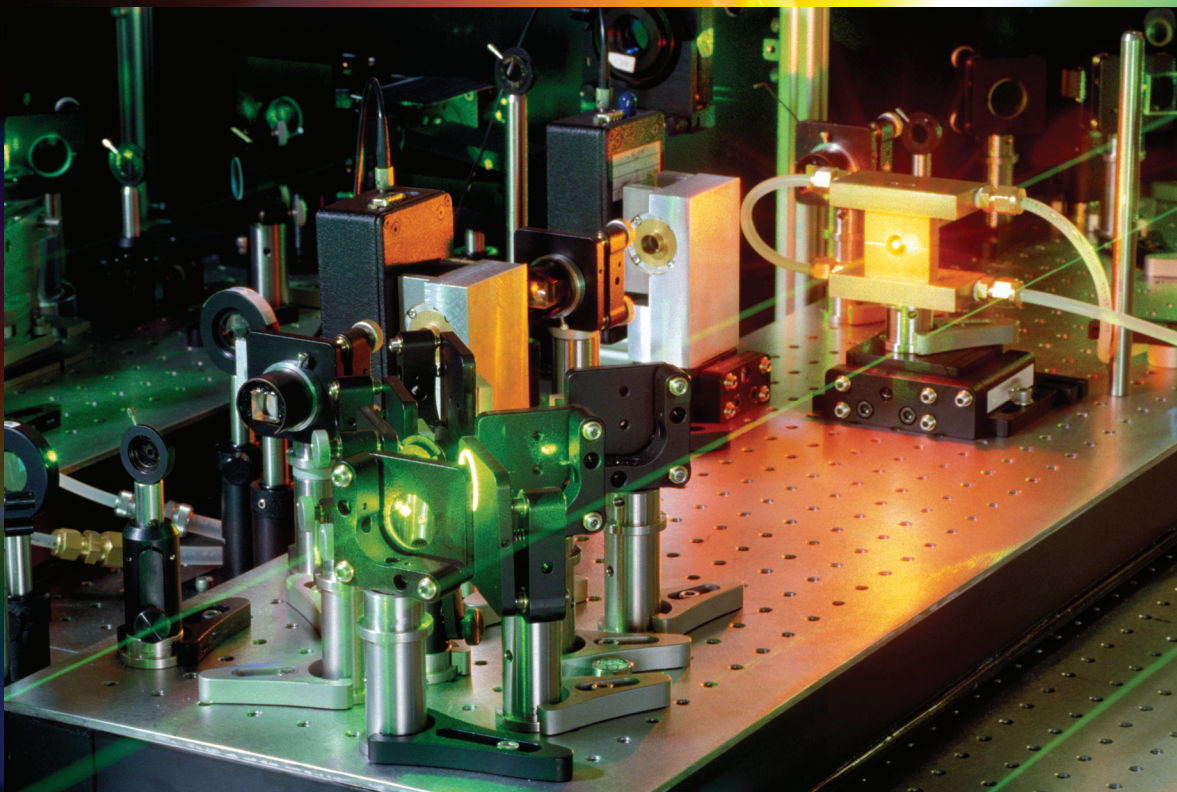

OP-TEC

Optics and Photonics Series

Course 2
Laser Systems
and
Applications

2nd Edition

OPTICS AND PHOTONICS SERIES



© 2016 University of Central Florida

This text was developed by the National Center for Optics and Photonics Education (OP-TEC), University of Central Florida, under NSF ATE grant 1303732. Any opinions, findings, and conclusions or recommendations expressed in this material are those of the author(s) and do not necessarily reflect the views of the National Science Foundation.

Published and distributed by
OP-TEC
University of Central Florida
<http://www.op-tec.org>

ISBN 978-0-9858006-5-9

Permission to copy and distribute

This work is licensed under the Creative Commons Attribution-NonCommercial-NoDerivatives 4.0 International License. <http://creativecommons.org/licenses/by-nc-nd/4.0>. Individuals and organizations may copy and distribute this material for non-commercial purposes. Appropriate credit to the University of Central Florida & the National Science Foundation shall be displayed, by retaining the statements on this page.

PREFACE

Introduction

Lasers are an “enabling technology,” which means that a wide variety of laser types are incorporated into systems for materials processing, medical applications, IT and communications, nanotechnology, defense, environmental monitoring, and other applications. Photonics Systems Technicians are needed to integrate, operate, maintain, repair, and calibrate these systems.

Photonics Systems Technicians (PSTs) work in industries whose processes and operations require the extensive use of photonics devices to meet production or mission goals. PSTs frequently integrate photonics devices or subsystems into larger systems, where photonics is an enabling technology. PSTs have the responsibility of ensuring these photonic devices operate within prescribed specifications and are compatible and/or complementary with the entire integrated system.

These technicians must know how these photonic devices operate and interface with the equipment or systems in which they are embedded. They must also understand how photonics devices and subsystems enable equipment and systems to accomplish specific tasks. These technicians must have broad, working knowledge and skills of electronic and electromechanical devices/systems, combined with their specialty knowledge and skills in photonics, to efficiently and effectively operate, maintain, repair, and calibrate photonics subsystems, and integrate these subsystems into full systems.

Laser Systems and Applications is the student text and laboratory manual for a two-semester, hands-on course to support curriculum for educating and training photonics systems technicians. It is preceded by a one-semester course, *Fundamentals of Light and Lasers* (see www.op-tec.org). These materials are used in Associate of Applied Science (AAS) curricula in two-year colleges, as well as for educating employed technicians. Several enhancements are available for faculty use by contacting OP-TEC. Among these are 1) Figures & Images for Instructors, 2) videos to introduce the lab activities, 3) solutions to problem exercises and questions, and 4) selected videos describing specific lasers and their applications, along with student assignments (questions) that can accompany each video.

Safety Precaution

Most of the lasers that are studied in this course are rated “Class IV” for safety purposes. All laboratory activities should consider the safety precautions specified in the module, which comply with ANSI Z-136.1 and ANSI Z-136.5 *Laser Safety Standards for Educational Institutions*. A faculty member of the educational institution is required to receive laser safety training for certification as the institution’s Laser Safety Officer. An overview of laser safety is included in OP-TEC’s Course #1, *Fundamentals of Light and Lasers*.

Acknowledgments

The original manuscripts of the ten modules in Course 2 were written by John Ready (Modules 2-1, 2-2, and 2-4 - 2-9), Jeff Hecht (Module 2-3) and Dan Hull (Module 2-10).

As project director, John Souders of OP-TEC provided leadership and editorial oversight for the course. Laboratories were developed by Feng Zhou (Indiana University of Pennsylvania,

Indiana, Pennsylvania), John Pedrotti (Texas State Technical College, Waco, Texas), Frank Reed (Indian Hills Community College, Ottumwa, Iowa), Gary Beasley (Central Carolina Community College, Lillington, North Carolina) and Todd Ewing (OP-TEC). Workplace scenarios were developed by Dan Hull (OP-TEC) and Gary Beasley, and Safety Considerations segments were developed by Fred Seeber (Camden County College, Blackwood, New Jersey).

Troubleshooting segments were developed by Hull and Reed. The Acronym Glossary and Module Indexes were compiled by Taylor Jeffrey, who coordinated the content revisions in the Second Edition based on comments from industry representatives and faculty who taught with the first edition of *Laser Systems and Applications*. Kelly Besecke edited the course materials, and Rachel Haferkamp of OP-TEC formatted them. Jeff Hecht granted permission to use in Module 2-3 figures that appear in his book *Understanding Lasers: An Entry-Level Guide, Third Edition*.

Special recognition is acknowledged to Dr. Leno S. Pedrotti (deceased), a pioneer laser educator who created original technician education materials that formed the basis for much of the modules in this text.

2ND EDITION FEATURES

Laser Systems: Operating principles, output characteristics, diagnostics, and applications for the six most widely used laser types. All important lasers are described and classified according to their active medium, output wavelength, and applications.

Real-World Applications: Students want to know what skills and knowledge they will need to succeed in future jobs and what kinds of responsibilities they might be assigned in the workplace. This text has three features that address these interests and bring real-world context to its content.

Safety Considerations: Students must understand that a main consideration of any photonics technician is safety. Technicians working in the photonics industry are constantly exposed to a variety of radiation sources that can pose safety hazards. To eliminate or minimize these hazards, students must learn the safety protocols for these radiation sources and know how to implement them. To facilitate this learning, each module includes a special section called *Safety Considerations*. This section provides information on these protocols and explains to students technicians' responsibilities in implementing them.

Troubleshooting Strategies: A prime skill that photonics technicians must master is troubleshooting. All students preparing for careers as photonics technicians need to study and practice the methodology of determining the source of failure in a system. The topic of troubleshooting is integrated throughout the course to provide students with basic strategies for determining the sources of failure in malfunctioning photonics systems and identifying common failure modes in various types of lasers. As they study these troubleshooting strategies, students will experience first-hand the work they will do as photonics technicians and will gain a sense of the skills and knowledge that employers will expect them to have.

Workplace Scenarios: These problem-based activities allow students to work in groups to generate solutions to problems that can arise in today's photonics organizations. Students take on technician roles as they work together in teams to use the material in each module to develop strategies for completing assigned tasks. These activities also give students an opportunity to enhance their writing skills: many activities require a report written in the form of an e-mail message or memorandum. The scenarios are instructor-friendly with full solutions and instructor notes provided. Teacher Notes and Solutions for the Workplace Scenarios can be obtained by instructors only through OP-TEC at www.op-tec.org/laser.

Navigation Enhancements: Features and additions to supplement navigation within the text.

Acronym Glossary: A comprehensive listing of the acronyms found within *Laser Systems and Applications*. Acronyms are listed and defined in alphabetical order. The Acronym Glossary can be found after Module 2-10.

Module Indexes: Each module contains an alphabetical listing of terms and ideas contained within that module, and the page numbers where they can be found.

OVERVIEW AND CONTENTS

Laser Systems and Applications, 2nd Edition is a two-semester course designed and developed by OP-TEC. Course 2 is designed for use by students and instructors involved in the preparation of technicians in the areas of optics, electro-optics, lasers, and photonics. OP-TEC's Course 1, *Fundamentals of Light and Lasers, 2nd Edition*, is a prerequisite.

Course 2, *Laser Systems and Applications, 2nd Edition*, contains the following ten modules:

1. *Laser Q-Switching, Mode Locking, and Frequency Doubling*
2. *Laser Output Characteristics*
3. *Laser Types and Their Applications*
4. *Carbon Dioxide Lasers and Their Applications*
5. *Fiber Lasers and Their Applications*
6. *Diode Lasers and Their Applications*
7. *Argon-Ion Lasers and Their Applications*
8. *Nd:YAG Lasers and Their Applications*
9. *Excimer Lasers and Their Applications*
10. *Systems Integration in Photonics*

These ten modules can be taught as a unit or independently, as long as prerequisites have been met. Modules 2-1 through 2-3 must be taught first. The remaining modules may be taught in any sequence after these.

Courses 1 and 2 were developed to provide educators with instructional materials that they could use with a wide variety of photonics students. These materials support dual-credit offerings for high school students in STEM career pathways. They provide students in AAS electronics programs the opportunity to add a photonics specialty to their degree and qualify for jobs as photonics system technicians. Because Course 1 and 2 cover basic photonics concepts, systems, and applications, they are excellent introductory courses for students in AAS programs in laser/electro-optics and photonics. Their content also allows them to be used as supplementary laser/electro-optics courses supporting students in related fields, such as biomedical equipment, manufacturing, defense, and nanotechnology. These courses can also be used to support currently-employed engineering technicians interested in retraining or updating their skills in optics and photonics. These courses are able to address a diverse range of students for two reasons. First, the courses offer broad coverage of photonics principles at a level of depth that technicians require. Second the courses' modular design means that individual modules can be taught independently, as long as prerequisites have been met, so there are a number of ways to “mix and match” the modules to address the needs of a wide variety of students.

The material in this text was developed by the National Center for Optics and Photonics Education, OP-TEC, under NSF grant numbers 1144377 and 1303732. Content specifications were determined from The National Photonics Skill Standards for Technicians Third Edition available at www.op-tec.org.

LABORATORY EQUIPMENT LIST FOR COURSE 2, LASER SYSTEMS AND APPLICATIONS, 2ND EDITION

Below is a partial list of equipment needed for the laboratories in Course 2. A full list of equipment would also include the equipment required for the *Fundamentals of Light and Lasers* course (2nd edition), which is a prerequisite for Course 2. The equipment list for *Fundamentals of Light and Lasers* can be found on page 33 of *Photonics Systems Technician Curriculum Guide*. The equipment listed below supports the lab station for each of the laboratories in Course 2. At the publication date of this edition of the course, the cost of this equipment is estimated at \$150,000. Some suppliers are offering educational discounts for their equipment. As equipment manufacturers introduce new equipment the list below may become outdated. To find the most current equipment list for Course 2 contact OP-TEC.

Course users can substitute for equipment in the list, but must be careful that replacement equipment has the capability of meeting laboratory technical objectives and safety considerations.

Course 2 Laboratory Equipment List

EQUIPMENT DESCRIPTION	QTY	VENDOR	STOCK NUMBER	LAB 2-1	LAB 2-2	LAB 2-3	LAB 2-4	LAB 2-5	LAB 2-6	LAB 2-7	LAB 2-8	LAB 2-9
ElectroViewer - IR Viewer	1	Cascade Laser Corp.	IRV7215-AC	X				X			X	
1000:1 Optical Attenuator	1	Coherent	1098318	X	X			X		X		
High-Sensitivity Optical Sensor OP-2 VIS Sensor	1	Coherent	1098313	X	X			X		X	X	
LabMax-TO Laser Power/Energy Meter	1	Coherent	1104619				X			X	X	X
PM30-30 Watt Thermopile	1	Coherent	1098314				X				X	X
ExciStar XS 200	1	Coherent	1115881									X
CO ₂ Laser (Diamond C-30A, Air Cooled)	1	Coherent	1138388				X					
Beam Imaging Camera, 190-1350 nm	1	DataRay Inc.	WCD-XHR					X	X	X	X	
Wedge Beamsplitter 3-10%	1	DataRay Inc.	CUB					X	X	X		
Amplifier for HgCdZnTe Detector	1	Boston Electronics	SIPDC-10				X					
HdCdZnTe Detector 10.6 microns	1	Boston Electronics	PVM-10.6				X					
400mW CO ₂ Laser	1	Edmund Optics	86-307				X					
Argon-Ion Laser, 150mW; Selectable Multi-line	1	Edmund Optics	58-453							X		
Fiber Laser	1	IPG Photonics	YLR-1-AC-Y13					X				
Nd:YAG Laser	1	PI miCos GmbH	CA-1230	X							X	
Frequency Doubling Crystal	1	PI miCos GmbH	CA-1231	X								
Active Q-switch	1	PI miCos GmbH	CA-1232	X								
Biased Photodiode Detector	1	Newport Corporation	818-BB-22					X				X
Laser Diode Control Kit	1	Newport Corporation	LDKIT-1.5A-TO						X			
Laser Diode	1	Newport Corporation	HL6320G TS09						X			
Red Tide Spectrometer, 350-1000 nm	1	Ocean Optics	USB-650						X	X		
100um Premium Fiber, VIS/NIR, 2 m, BX Jacket	1	Ocean Optics	QP100-2-VIS-BX								X	
UV-VIS Collimating Lens, 200-2000 nm	1	Ocean Optics	74-UV								X	
ESD Benchtop Grounding Mat	1	Digi-Key Electronics	16-1206-ND						X			
Oscilloscope*	1	use available item		X		X	X				X	X
Computer**	1	use available item						X	X	X	X	

SAFETY EYEWEAR	QTY	VENDOR	STOCK NUMBER	LAB 2-1	LAB 2-2	LAB 2-3	LAB 2-4	LAB 2-5	LAB 2-6	LAB 2-7	LAB 2-8	LAB 2-9
Laser Safety Glasses	2	Laser Safety Industries	100-10-125	X								
Laser Safety Glasses	2	Laser Safety Industries	100-38-115		X				X			
Laser Safety Glasses	2	Laser Safety Industries	100-50-101				X					
Laser Safety Glasses	2	Laser Safety Industries	100-38-120					X				
Laser Safety Glasses	2	Laser Safety Industries	100-10-110							X		
Laser Safety Glasses	2	Laser Safety Industries	100-10-125								X	
Laser Safety Glasses	2	Laser Safety Industries	100-50-101									X

*Recommended Oscilloscope should include the a minimum of:

- 200 MHz Bandwidth
- 2 to 4 Channel Models
- Up to 1GS/s Sample rate
- 2.5k Point Record Length/Channel
- Advanced Triggers

**Recommended Computer should include the minimum of:

- 2 GHz Processor
- 2 MB of Cache
- 8 GB RAM
- 500 GB Hard Drive
- 10/100 Ethernet
- USB Port
- 64-bit Processor

Laser Q-Switching, Mode Locking, and Frequency Doubling

Module 2-1

of

Course 2, *Laser Systems and Applications*
2nd Edition

OPTICS AND PHOTONICS SERIES



© 2016 University of Central Florida

This material was developed by the National Center for Optics and Photonics Education, OP-TEC, and is based upon work supported by the National Science Foundation under Grant No. 1144377 and completed under Grant No. 1303732. Any opinions, findings, and conclusions or recommendations expressed in this material are those of the author(s) and do not necessarily reflect the views of the National Science Foundation.

For more information about the text or OP-TEC, contact:

Dan Hull
PI, Executive Director, OP-TEC
316 Kelly Drive
Waco, TX 76710
(254) 751-9000
hull@op-tec.org

Published and distributed by
OP-TEC
316 Kelly Drive
Waco, TX 76710
254-751-9000
<http://www.op-tec.org/>

ISBN 978-0-9983480-0-1

CONTENTS OF MODULE 2-1

Introduction	1
Prerequisites	2
Objectives	3
Basic Concepts	4
Q-Switching: Basic Principles and Techniques	4
Theoretical Basis of Q-Switching	4
Effects of Q-Switching on Laser Parameters	8
Q-Switching CW Lasers.....	13
Current Uses and Applications of Q-Switches.....	16
Summary of Q-Switching.....	16
Mode Locking: Generating Ultrashort Laser Pulses	17
A Particle Description of Mode Locking	17
Mode Locking from a Wave Perspective.....	18
Active and Passive Mode Locking.....	20
Ultrashort Pulse Lasers.....	20
Frequency Doubling in Nonlinear Materials.....	22
Linear and Nonlinear Behavior of Physical Phenomena	22
Nonlinear Optical Materials	27
Damage.....	29
Laboratory	31
Workplace Scenario	38
Problem Exercises and Questions	40
References	41
Index of Terms	42

Module 2-1

Laser Q-Switching, Mode Locking, and Frequency Doubling

INTRODUCTION

The following is a brief review of laser fundamentals that will be used in this module.¹

- A laser contains four elements:
 1. Amplifying Medium (solid, gas, liquid, or semiconductor).
 2. Excitation Mechanism (radiation from flash lamps, arc lamps, and other lasers, electrical current, or chemical reactions).
 3. Feedback Mechanism (An *optical cavity* composed of reflecting devices, such as plane and curved mirrors, that constitute the laser's optical axis.) This forms a "feedback path" for radiation to reenter the amplifying medium.
 4. Output Coupler (Typically, one of the mirrors in the feedback mechanism is partially reflective, which results in part of the intracavity beam being transmitted as the laser output.)

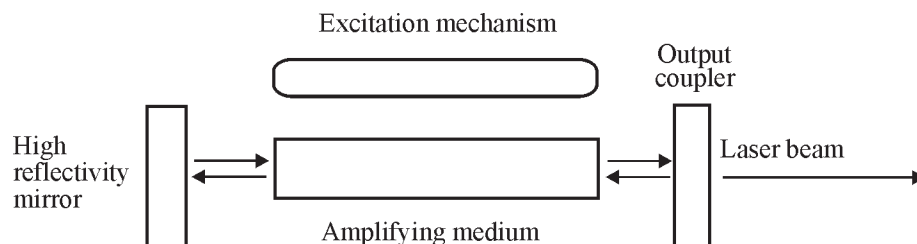

Schematic diagram showing the basic structure of a laser

- Lasers can operate in either a continuous (CW) or a single-pulsed mode
 - Lasers that are pumped (excited) continuously can produce a continuous output or a series of pulses.
 - Lasers that are pumped (excited) by a pulse of energy will emit an output pulse (or string of irregular pulses) that coincides in time with the pumping pulse.

¹ *Fundamentals of Light and Lasers, 2nd Edition*, National Center for Optics and Photonics Education (OP-TEC), 2012.

- Solid or gas lasers, which have external mirrors for the optical cavity, may contain “intracavity elements” that can control the output pulses by varying the reflectivity of the optical cavity. They are called *Q-switches* or *mode lockers*.
- A different type of intracavity element may be used to recombine the laser beam into a shorter wavelength output (doubled frequency).
- Solid state lasers can operate in continuous wave (CW) or pulsed mode. In the CW mode, the power output of a solid state laser undergoes little or no fluctuation. When the flashlamps of these lasers are pulsed, laser emission begins when the population inversion is high enough and ends when the population inversion falls below the threshold for laser operations. Operating in this mode—normal pulsed mode—the output of the laser undergoes marked fluctuations; that is, the beam’s power changes with time in a very noticeable fashion that resembles a series of pulses.
- The output of a normal mode, pulsed, solid state laser is generally a train of irregular pulsations—irregular in peak power, pulse width, and frequency of occurrence. It is possible to remove these irregularities and at the same time greatly increase the peak power by using a technique called *Q-switching*. Q-switched lasers normally emit only one giant pulse in an operational cycle. The pulse will typically have a time duration of less than one microsecond and a peak intensity of megawatts (10^6 watts) or even gigawatts (10^9 watts). This same technique may be applied to continuously pumped lasers to produce a train of Q-switched pulses with regular duration, pulse shape, peak power, and frequency of occurrence (pulse repetition frequency).
- Another technique for producing short, high-power pulses is *mode locking*. In a laser with multiple longitudinal modes, the modes may interfere so as to produce a very short pulse. The shortest laser pulses are produced by this technique. Pulses with duration in the femtosecond (10^{-15} s) range have been produced.
- Also, it is possible to change the wavelength of a laser to a shorter wavelength using a process called *nonlinear optics* (NLO). Usually, this procedure produces an output at a frequency equal to twice the original frequency (half the original wavelength), although outputs at three or four times the original frequency have been obtained. Despite this, the process is usually referred to as *frequency doubling*.

The purpose of this module is to explain the operation of Q-switches, mode lockers, and frequency doubling devices, describe how they modify the output of a laser, and provide laboratory experience to measure this output.

PREREQUISITES

OP-TEC’s *Fundamentals of Light and Lasers Course*

Understanding of high school level trigonometry and algebra concepts to include exponentials and logarithms

OBJECTIVES

Upon completion of this module, the student should be able to:

- Explain the basic principles of Q-switching, including the concepts of amplifier gain, loop gain, and cavity “quality”.
- Draw and label diagrams showing the time histories of input light, stored energy, amplifier gain, loop gain, and output for the cases of feedback mirrors removed, normal mode operation, and Q-switched operation.
- Compare the pulse duration and peak power of normal pulse and Q-switched lasers.
- List and explain the four most important characteristics of Q-switches.
- List and explain the operation of the four major types of Q-switch.
- Explain the factors that reduce the efficiency of a typical Q-switched laser as compared with a normal pulse laser.
- Name a laser type that cannot be Q-switched and explain why this is so.
- Given the laser parameters, determine the dynamic loss needed for a Q-switch to prevent lasing.
- Describe what is meant by mode locking.
- Describe two methods of mode locking.
- Give two examples of mode locked lasers that have been widely used.
- Given the bandwidth of the emission spectrum of a material, determine the approximate minimum pulse duration that could be obtained from it in a mode locked pulse.
- Give at least two examples of applications for mode locked lasers.
- Describe the nonlinear behavior of a system using appropriate equations.
- Explain second harmonic generation of light with the aid of the induced charge polarization.
- Differentiate between passive and active nonlinear materials.
- List and rate the importance of some of the more common nonlinear materials.
- Operate a pulsed solid state laser in the laboratory in both the normal pulse mode and in the Q-switched mode. Measure the output characteristics of each and compare them.
- Operate a mode locked laser in the laboratory and measure relevant output characteristics.
- Operate a frequency doubled laser in the laboratory and measure relevant output characteristics.

BASIC CONCEPTS

Q-Switching: Basic Principles and Techniques

Q-switching is a mode of operating a laser in which energy is stored in the laser material during pumping in the form of atoms in the upper laser level and suddenly released in a single, short burst. This is accomplished by changing the feedback of the laser cavity. During pumping, the high-reflectivity (HR) mirror is effectively removed from the system, preventing lasing. After a large amount of energy has been stored in the active medium, the HR mirror is returned to proper alignment and operation, and most of the stored energy emerges in a single, short pulse.

The extremely short, high-energy output pulse will occur at a predictable time. This makes the Q-switched laser an ideal transmitter source for rangefinders and surveillance radar. Q-switched lasers are also used to produce rapid, localized heating in materials. Q-switched lasers can be classified for study according to two criteria:

1. Whether they have a continuous or pulsed pumping source.
2. The methods and equipment used to “Q-switch” them.

To understand these classifications, we will present an overview of Q-switching theory; show how this theory applies to continuously pumped laser systems; and briefly present several Q-switching techniques. The intent of these presentations is to provide an introduction to the subject of Q-switching. Those requiring more detail or depth on this subject should study the references presented at the end of this module.

Theoretical Basis of Q-Switching

Q-switching is a method of controlling the laser energy by controlling the gain in the laser cavity. This section is a review of the factors affecting energy storage and gain in the amplifying medium (also called the active medium) of the laser cavity.

Absorption and Gain in the Active Medium

The absorption and emission of light in optical materials were described briefly in Modules 2 and 3 of the *Fundamentals of Light and Laser* course. Now we present a more detailed discussion. The absorption of light in a material is described by Equation 1-1:

$$I = I_0 e^{-kx} \quad (1-1)$$

- where:
- I_0 = Intensity of light entering the material.
 - I = Intensity of light at a distance, x , inside the material.
 - x = Distance into material.
 - k = Absorption coefficient, characteristic of a particular material at a particular wavelength. (The expression in Equation 1-1 is limited to materials and conditions in which most of the atoms are in the ground state E_1 .)

Previously the symbol α was used for the absorption coefficient. We have chosen to use k in this application so that we can use α later in its more traditional use as the gain coefficient.

When light is absorbed in a material, it typically raises the energy of the absorbing material from one energy level (E_1) to another (E_2) in accordance with the following equation:

$$E_2 - E_1 = \frac{hc}{\lambda} \quad (1-2)$$

where h is Planck's constant and λ is the wavelength of the light entering the material. In a laser system, the absorption of light from an external source, known as pumping, is specifically designed to raise atoms from the ground state (E_1) to one of the upper lasing energy levels (E_2), thus causing a population inversion. This redistribution of energy from the ground to the upper lasing levels has an effect on the absorption coefficient, k , that enhances the output of a laser by reducing the absorption of light emitted by stimulated emission. This effect is best described using Equation 1-3.

Equation 1-3 shows the dependence of k on the population of lower and upper transition states within a laser.

$$k = C(N_2 - N_3) \quad (1-3)$$

where: k = Absorption coefficient.
 C = A constant of proportionality characteristic of the transition.
 N_2 = Number of atoms in the lower state of the transition.
 N_3 = Number of atoms in the upper state of the transition.

As this equation indicates, absorption is greatest when the population of the lowest state is much greater than the population of the higher energy state.

As already stated, the excitation or pumping mechanism of the laser moves atoms from the ground state to the upper lasing level. This reduces the difference in populations between the upper and lower lasing levels. When the two populations are the same, the absorption coefficient is zero, and there is no absorption of the light emitted by stimulated emission. At this point, stimulated emission and absorption occur at the same rate and balance one another.

Additional pumping will increase the population of the upper lasing level above that of the lower lasing level, creating a population inversion. When this occurs, the value of the absorption coefficient k becomes negative. This indicates that the intensity of a light beam increases as it moves through the material. Thus, in this case, the laser active medium produces gain at the laser wavelength.

Equation 1-4 is a mathematical expression for gain in the active medium of a laser.

$$G_a = \frac{I}{I_0} = e^{\alpha l} \quad (1-4)$$

where: G_a = Amplifier gain (single-pass gain of active medium)
 α = Gain coefficient
 l = Length of the active medium

This is the same form as Equation 1-1 with $\alpha = -k$. This change in sign and notation is made so that the gain coefficient is a positive number and so that a higher gain coefficient indicates greater gain. The physical mechanisms for absorption and gain are the same, and the process that dominates the energy transfer depends upon the relative populations of the two energy states involved. A greater population inversion results in greater amplifier gain for the laser.

Energy Storage in the Active Medium

Figure 1-1 is a simplified energy-level diagram of a four-level laser. Pumping adds energy to the active medium in the form of atoms raised in energy from the ground state to the pumping band. These decay rapidly to the upper lasing level. This state has a relatively long lifetime (metastable state), and its population increases to produce a population inversion between states E_3 and E_2 of Figure 1-1. Thus, energy is stored in the active medium in the form of excited atoms in the upper lasing level. This stored energy is released through stimulated emission as the optical energy of the laser output. In lasers without Q-switching, this energy is used immediately. The fluctuations in stored energy (and thus in amplifier gain) produce the spiked output characteristic of pulsed solid state lasers. In CW lasers, pumping and stimulated emission occur at constant rates, producing a constant output. In either case, the lasing process constantly uses the stored energy, thus depleting the population inversion. However, if lasing is interrupted while pumping continues, both stored energy and amplifier gain can be increased to levels greater than those associated with the normal lasing process.

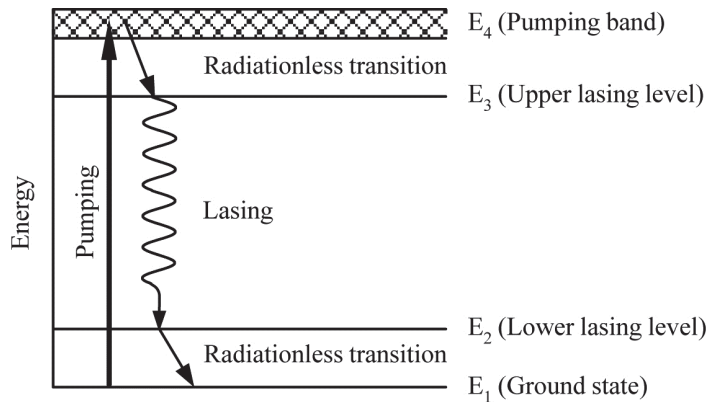

Figure 1-1 Simplified energy-level diagram of four-level solid state laser

Loop Gain of the Optical Cavity

Figure 1-2 shows the laser cavity of a normal mode, pulsed, solid state laser. It consists of a laser rod between two plane parallel mirrors. The loop gain of such a laser cavity is the gain experienced by the light signal in one complete round-trip of the laser cavity. Factors contributing to loop gain are two passes through the laser cavity, reflection from each mirror, and losses within the cavity. Equation 1-5 is an expression for loop gain.

$$G_L = G_a^2 R_1 R_2 (1 - L) \quad (1-5)$$

where: G_L = Loop gain
 G_a = Amplifier gain
 R_1 and R_2 = Fractional reflectivity of mirrors
 L = Fractional round-trip cavity loss

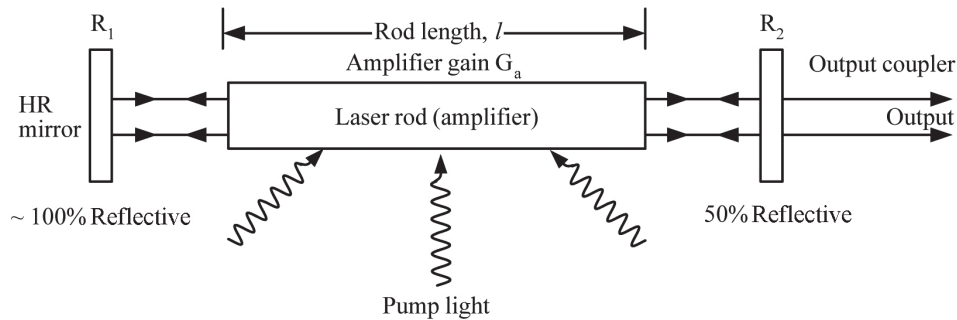

Figure 1-2 Diagram of a normal mode, pulsed laser

If the loop gain is greater than one, the signal strength within the laser cavity increases with each round-trip. Since the output power is directly proportional to the strength of the optical standing wave in the cavity, the laser power also increases. If the loop gain is less than one, the output power of the laser decreases. CW lasers in steady-state operation have a constant loop gain of 1.0.

The conditions for lasing to begin in any laser may be determined by setting the loop gain equal to 1.0 and solving Equation 1-5 for G_a . This yields Equation 1-6.

$$G_a = \frac{1}{\sqrt{R_1 R_2 (1 - L)}} \quad (1-6)$$

This equation indicates that lasing will begin when the amplifier gain is sufficient to overcome all optical losses from the laser cavity, including the laser output and *fluorescence*. Fluorescence is the process by which atoms excited by the pumping mechanism in a laser spontaneously reduce their energy by the emission of a photon. Since these atoms do not release this photon by stimulated emission, the light produced does not contribute to the coherent light associated with a laser's output, but instead represents a loss.

Q-Switching and Gain

The term "Q," as related to the operation of lasers, is used to describe the quality of the resonant cavity; that is, how well it couples the intracavity signal back into the amplifier. In a practical way, we can relate Q to the losses in the feed loop through the cavity. In this loop, the signal encountered gain (became more intense) when it traveled through the laser active medium, and encountered losses when it reflected off the mirrors and entered and left the active medium. It

also encountered losses from diffraction and the imperfect optical quality of the laser active medium and mirror surfaces. If the signal was larger after it made a loop through the cavity, then in successive trips it would “build up” or become more intense, and lasing would occur. A laser output is observed because a percentage of the optical signal inside the cavity is transmitted through the partially reflecting output mirror.

The factor Q in a laser cavity consisting of a 100% reflecting mirror and a mirror with reflectivity R is given by Equation 1-7:

$$Q = 2D\omega/(1 - R)c \quad (1-7)$$

where D is the distance between the mirrors, ω is the angular frequency of the light produced from stimulated emission, and c is the speed of light. According to this equation, when R is high, close to unity, Q will be very high and energy will be stored within the cavity. When R is lower, appreciably less than unity, Q will be lower and energy can escape from the cavity. Q-switching involves switching the reflectivity of the output mirror from a high to a low value at a time when the active medium has been pumped to a highly excited state.

When a laser is “Q-spoiled,” a physical change is made in the feedback loop of the laser cavity that drastically lowers the effective reflectance of the cavity during pumping. A lower reflectance reduces the amount of light reflecting from the laser mirrors. Less reflected light leads to less stimulated emission and more atoms staying in their excited state. This prevents the system from lasing and allows the population inversion to increase without an output being generated—resulting in an increase in amplifier gain (G_a) and stored energy in the upper lasing level. At the time of maximum population inversion (usually near the end of pumping) the Q is switched back to a high value by reforming the cavity, causing the system to lase, and thereby releasing its available, stored energy in one, short “giant pulse.”

Q-switching is accomplished by introducing large losses (low reflectance) into the laser cavity during pumping. This prevents the loss of stored energy due to lasing until the stored energy and amplifier gain both reach a high value. The loss is then reduced to its lowest value (high reflectance), resulting in a loop gain that greatly exceeds that possible without Q-switching. This high gain results in a very quick buildup of the light signal in the cavity and uses most of the energy stored in the active medium to produce a single, short-duration, high-peak-power pulse.

A Q-switch is essentially a shutter placed between the active medium and the HR mirror. With this shutter closed, the HR mirror is blocked (low reflectance) preventing feedback and lasing. When the amplifier gain reaches a predetermined value, the shutter is opened (high reflectance) to increase the cavity quality. Four major Q-switch types are discussed later in this module.

Effects of Q-Switching on Laser Parameters

A more detailed understanding of the energy exchanges during Q-switching and the requirements for the Q-switch characteristics may be achieved by examining several laser parameters during laser operation with and without feedback mirrors and Q-switching. These are illustrated in Figures 1-3, 1-4, and 1-5. Figure 1-3 shows the time histories of pump light, stored energy, amplifier gain, loop gain, and laser output for a solid state laser active medium with no feedback mirrors. Figure 1-4 shows the same parameters for normal mode laser operation, and Figure 1-5 illustrates Q-switched operation of the same laser. In each case, the

pumping source was picked to be a square pulse with negligible rise and fall times. The curves are the same size and on separate sheets so that they can be superimposed to compare one situation with another. Each case is described below.

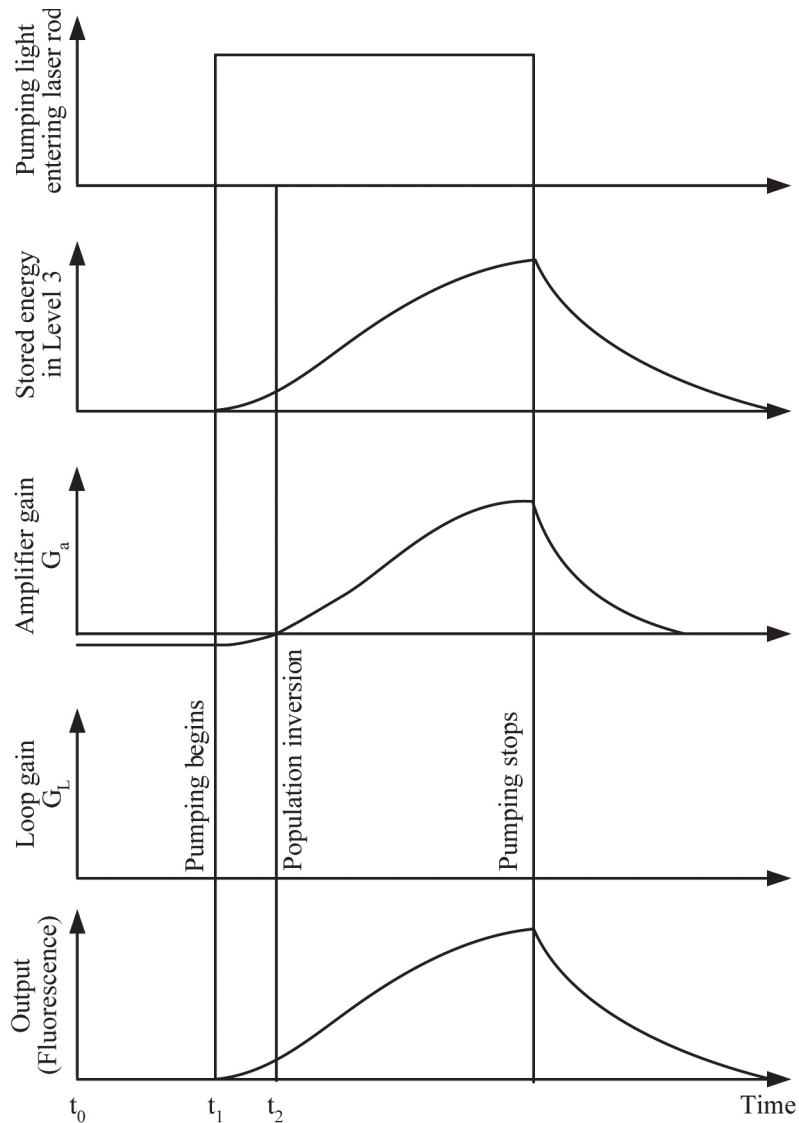

Figure 1-3 Time history of laser parameters during pulse pumping; no feedback mirrors in laser

Laser Parameters without Feedback

Figure 1-3 shows the laser parameters during the pumping cycle of a solid state laser with the cavity mirrors removed. At the beginning of the pumping pulse (time t_1), stored energy is essentially zero, and the amplifier gain is less than zero. The gain coefficient is negative as some absorption occurs until a population inversion is reached. Stored energy and amplifier gain both rise as light energy is absorbed into the laser rod. At t_2 , a population inversion is established and the amplifier gain rises past zero. The loop gain remains zero since there are no mirrors. Thus, the system cannot lase. The entire output is fluorescence (spontaneous emission), which begins at the beginning of pumping and rises with stored energy. After pumping ends, the fluorescence

continues until all the energy stored in the active medium has been released through spontaneous emission.

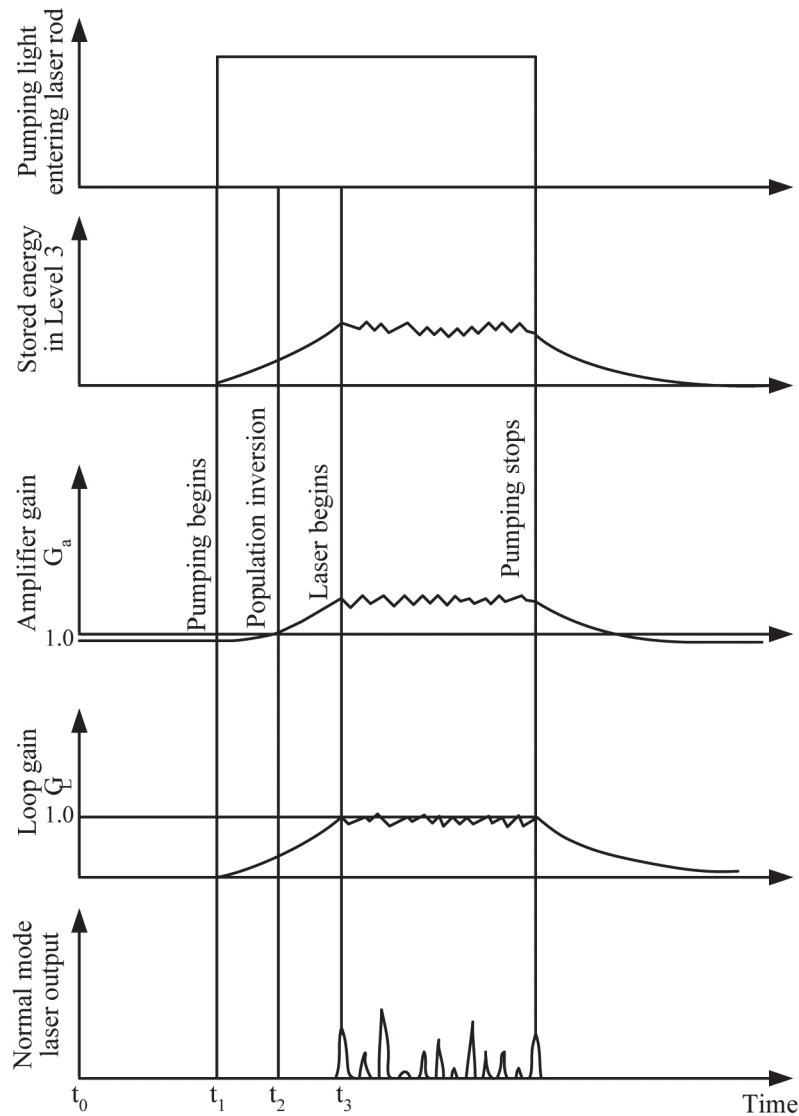

Figure 1-4 Time history of laser parameters during pulse pumping, normal mode operation—three-level laser material

Laser Parameters for Normal Mode Lasing

Figure 1-4 shows the same parameters for the same laser with the feedback mirrors in place. The stored energy and amplifier gain curves are the same as in Figure 1-3 until time t_3 . At this time, the amplifier gain has risen to the level necessary to overcome all loss from the cavity, and the loop gain passes 1.0. Lasing begins and quickly depletes the stored energy. This reduces the amplifier gain, the loop gain drops below 1.0, and lasing dies out. The result is an output spike with a typical duration on the order of 100 ns.

Since lasing has stopped and no longer lowers the gain, stored energy once again builds up. This process is repeated many times in rapid succession for each longitudinal mode of the laser,

producing the typical spiked output of a pulsed solid state laser. Since the stored energy is constantly depleted by the lasing process, it never reaches the high values of Figure 1-3. Both amplifier gain and loop gain remain relatively close to 1.0, with amplifier gain varying between values above 1.0 and loop gain varying from above that value to below it. This process continues until pumping stops.

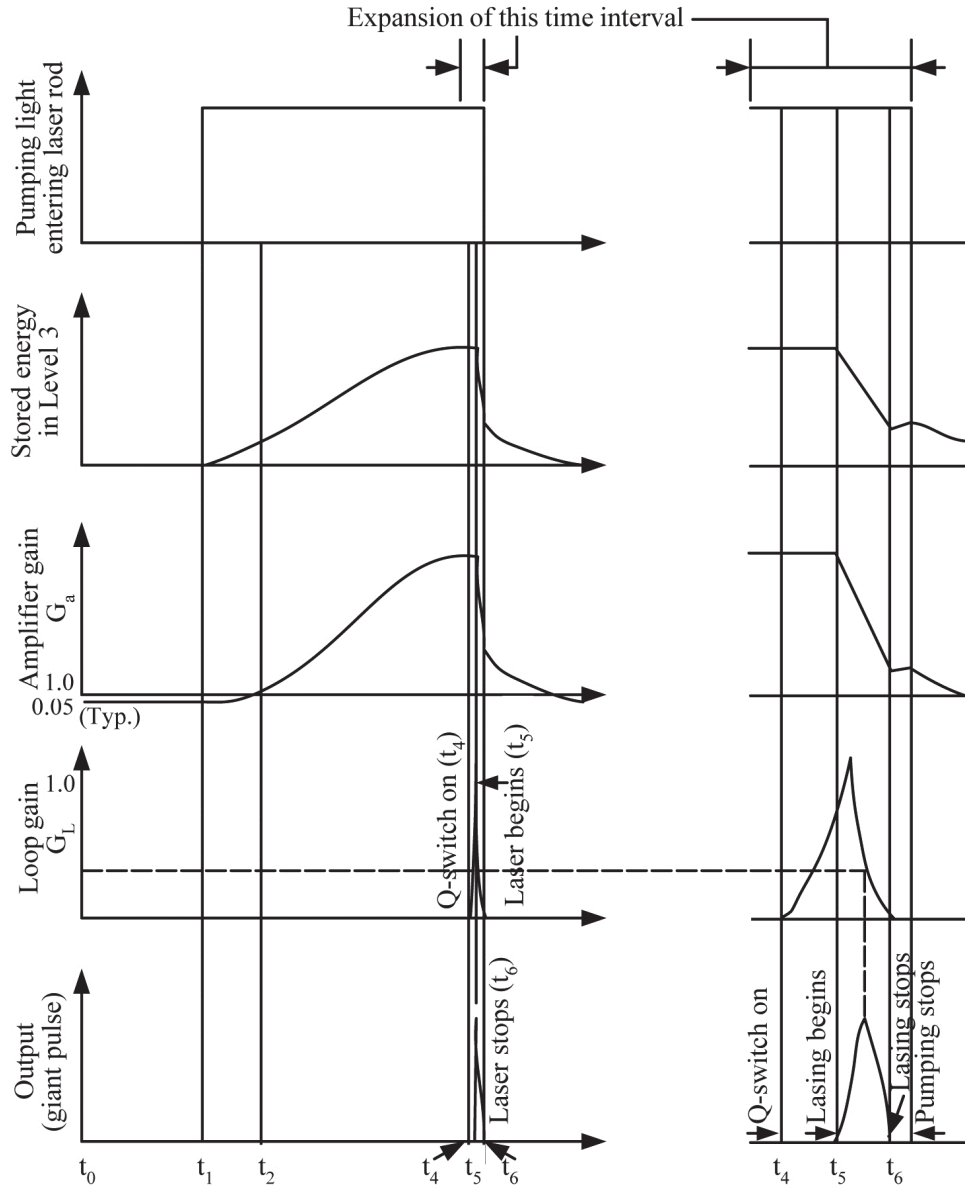

Figure 1-5 Time history of laser parameters during pulse pumping and Q-switching

Q-Switched Laser Parameters

Figure 1-5 is a time history of the same material, pumped in the same manner, but in this case, the percent feedback from the reflective mirrors is suddenly varied from very low to very high—causing the system to Q-switch. In this case, the time descriptions of stored energy and amplifier gain are the same during optical pumping as they are in Figure 1-3, where there is no feedback at all. Observe that the amplifier gain and stored energy in the laser active medium

reach significantly higher values than in the normal mode case in Figure 1-4. At a time near the end of the optical pumping (t_4), the feedback from the reflective mirrors in the laser cavity rapidly switches to its maximum value, causing the system to emit a large pulse of light. During the time of this output pulse ($\approx 10^{-8}$ s), the energy being put back into the laser active medium by pumping is insignificant.

Lasing begins when the loop gain passes 1.0 at time t_5 . The laser pulse builds rapidly depleting stored energy and amplifier gain. The peak of the laser output pulse occurs as the loop gain falls below the 1.0 level. After this, the output power drops off as loop gain remains below 1.0.

The duration of the output pulse may be determined in two ways. In Figure 1-5, the Q-switch has “closed” to lower loop gain and stopped lasing before all the stored energy has been used. This shortens the laser pulse and reduces the pulse energy, since some of the energy remains in the laser active medium. This energy is depleted through fluorescence. In this figure, pumping continues slightly beyond the laser pulse. This extra input energy contributes to fluorescence only. In some systems, the Q-switch may remain in the “open” condition, with pumping ending during the Q-switch cycle. This will result in a slightly longer-duration output pulse.

The energy of the Q-switched output pulse is generally on the order of 10% of the pulse energy available from normal mode operation. One factor contributing to this is that some of the energy is usually left in the active medium. Another is that fluorescence begins with pumping, and considerable energy is lost through spontaneous emission before the Q-switch opens.

During normal mode operation, each atom in the active medium may participate in the lasing process several times. In a Q-switched laser, each atom lases only once. This further reduces laser efficiency.

The delay time between the beginning of pumping and the opening of the Q-switch is dictated by the lifetime of the upper lasing level of the active medium. The amplifier gain and stored energy rise from the beginning of pumping until this lifetime is exceeded. Delaying Q-switch operation beyond this lifetime will not result in more stored energy, because energy is lost to fluorescence at the same rate as it is added by pumping. Obviously, the greater the fluorescent lifetime of the laser material, the more energy may be stored in the active medium. All solid state laser systems may be effectively Q-switched, because their fluorescent lifetimes fall in the range of 0.2 to 0.3 ms. Molecular gas lasers such as CO₂ are also often Q-switched. Ion lasers cannot be effectively Q-switched, because the lifetime of their upper lasing level is too short, allowing insufficient time to build up a large amount of stored energy.

Table 1-1 presents some representative values for outputs of pulsed Nd:YAG lasers operating at a wavelength of 1064 nm. These values are not the best ever obtained, but represent what may easily be obtained in commercially available lasers.

Table 1-1. Typical Values for Pulsed Nd:YAG Lasers Operating at 1064 nm Wavelength

Operation	Pulsed Energy (J)	Pulse Duration (μ s)	Peak Power (W)
Non Q-Switched	Tens of J	500	40000
Q-Switched	Few J	0.05	100,000,000

Q-Switching CW Lasers

CW solid state lasers may be pumped continuously and Q-switched repetitively to produce a regular train of output pulses. The most common examples of this are CW Nd:YAG lasers. Since the pumping rate is much lower for CW systems, the maximum stored energy is also lower, and the resulting peak power is lower (typically 10^3 to 10^4 watts).

Nd:YAG is by far the most common Q-switched, CW pumped laser system. Such systems can typically produce several thousand pulses per second without degradation of the pulse energy. Typical pulse durations for such a system range from several hundred nanoseconds to a few microseconds. Molecular gas lasers, like CO₂ lasers, can also be pumped. In later modules of this course, the detailed operation of both these lasers will be presented.

Methods of Q-Switching

Several techniques have been used for Q-switching lasers. Each has its advantages, disadvantages, and specific applications. This section discusses the four most important types of Q-switches. While many Q-switch characteristics are important to specific applications, the following four characteristics are generally most important:

1. Dynamic loss is the maximum loss introduced in the laser cavity when the Q-switch shutter is “closed.” Ideally, the dynamic loss should be 100% to ensure that lasing cannot occur until the Q-switch is opened.
2. Insertion loss is the minimum loss introduced by the presence of the Q-switch in the “open” condition. Ideally this is zero, but most Q-switches include optical surfaces that introduce reflection and scattering losses.
3. Switching time is the time necessary for the Q-switch to open. Faster switching times result in shorter, higher-peak-power pulses because the switch can become fully open before lasing has a significant effect on the population inversion. Slower switches allow significant amounts of the stored energy to be depleted before the Q-switch is fully opened. This lowers the maximum loop gain of the system and “stretches out” the output pulse.
4. Synchronization is an indication of how well the laser output can be timed with external events. Some Q-switches allow precise control of when the output pulse occurs. Others offer virtually no control at all.

To describe various Q-switching techniques, we use a simple representation of the laser cavity as shown in Figure 1-6, 1-7, 1-8, 1-9 and 1-10. In these figures, M₁ is the output coupler mirror and M₂ is the high-reflectance mirror.

Mechanical Q-Switches

Two of the devices in this category are a light chopper and a spinning mirror. See Figures 1-6 and 1-7.

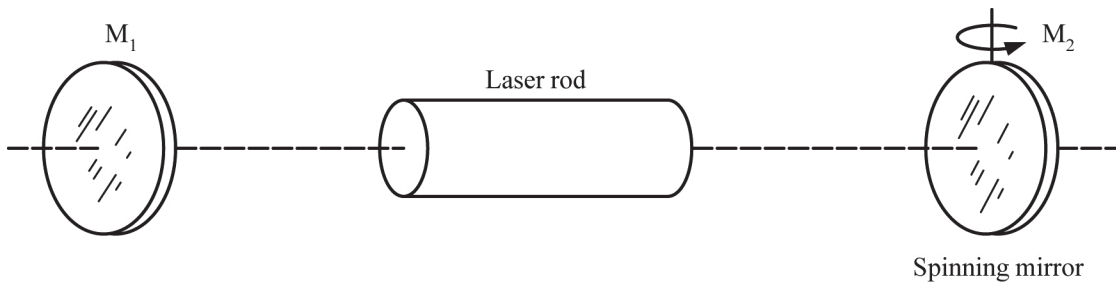

Figure 1-6 Mechanical Q-switch (spinning mirror)

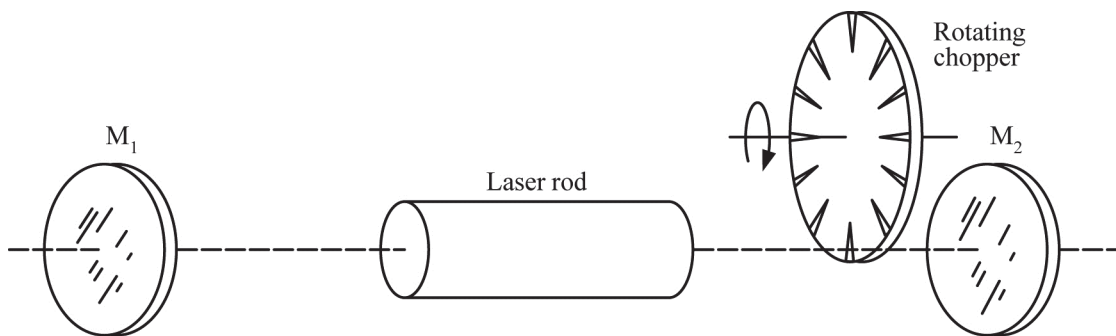

Figure 1-7 Mechanical Q-switch (rotating chopper)

Spinning reflectors have been used in Q-switched systems when it is not necessary to closely synchronize the output to some other event. Usually, the maximum-reflectivity mirror is rotated so that the mirror is tilted out of alignment. The system is Q-switched when the mirror rotates back into alignment (it is in alignment once during each revolution). Rotating mirror Q-switches offers 100% dynamic loss and 0% insertion loss. The Q-switch speed can be made fast enough by rotating the mirror at high speed (20,000 to 60,000 rpm) or by using various optical schemes to multiply the effect of the rotating element. Switching time is typically a few nanoseconds.

A light chopper is a spinning disc with a hole in it or a spinning blade (like a fan blade). The chopper is inserted into the laser cavity between the active medium and the maximum reflectivity mirror. This system provides 100% dynamic loss and 0% insertion loss. A chopper is so slow, however, that it can Q-switch only a fraction of the beam area at a time as it is swept across the aperture. For this reason, light chopper Q-switches are not practical or effective.

In both the chopper and spinning reflector, it is necessary to synchronize the firing of the pumping mechanism with the position of the spinning element so that the pumping pulse occurs before the system is Q-switched. Synchronization of the output pulse in mechanical systems is poor. Rotating mirror Q-switches may be used with either pulsed or CW pumped lasers.

Electro-Optic Q-Switches

These devices—see Figure 1-8—usually require the placing of two elements into the laser cavity between the active medium and the maximum reflecting mirror. These elements are a polarization filter (passive) and a polarization rotator (active). Producing a low cavity feedback with these devices involves rotating the polarization vector of the laser beam inside the cavity so that it cannot pass through the polarization filter. When this polarization rotation is removed, the cavity reflectivity is relatively high, and the system will produce a large pulse. Two of the electro-optic devices used to produce this polarized rotation of the laser beam are Kerr cells and Pockel's cells. Electro-optical Q-switches have high dynamic loss (99%) and relatively high insertion losses (15%) because of the losses in the optical elements. Switching time is fast—typically less than a nanosecond—and synchronization is good. Electro-optical Q-switches are well suited for pulsed systems but cannot be used with CW pumped lasers, because their high insertion loss prevents lasing.

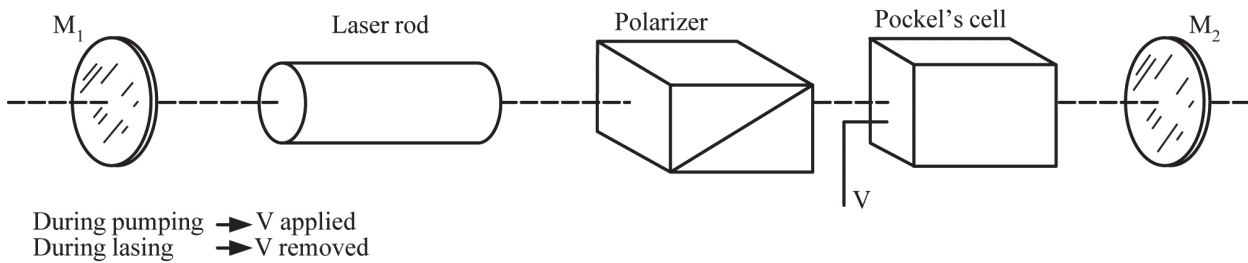

Figure 1-8 Electro-optic Q-switch

Acousto-Optic Q-Switches

This technique involves the use of a transparent element placed in the laser cavity between the active medium and the maximum-reflectivity mirror. This transparent device—see Figure 1-9—when excited with intense, standing, acoustic waves has a diffraction effect on the intracavity laser beam; it diffracts part of the beam out of alignment with the cavity. This results in a relatively low feedback. When the acoustic wave is removed, the diffraction effect disappears, the beam is again aligned with the cavity, and the system emits a large pulse. Acousto-optic devices have low insertion loss (typically less than 1%) and low dynamic loss (50% maximum). Switching time is slow at 100 ns or greater, but the synchronization is good. These devices are ideally suited for use with CW pumped systems or low-gain pulsed lasers. They cannot be used with most pulse pumped systems because their low dynamic loss will not prevent lasing.

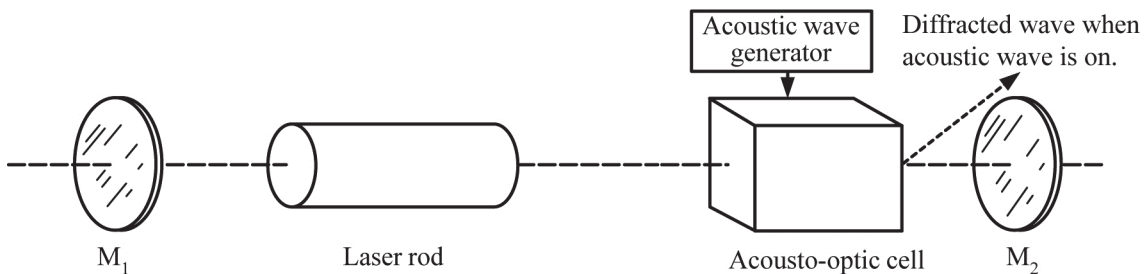

Figure 1-9 Acousto-optic Q-switch

Bleachable-Dye Q-Switches

Bleachable dyes are available as thin films on glass substrates or as liquids in glass “windowed” cells. See Figure 1-10. For Q-switching, a dye cell is placed in the laser cavity between the amplifier and the maximum-reflectivity mirror. The dye absorbs the laser wavelength very strongly at low light intensities, presenting a very high cavity loss to the laser and preventing lasing until the amplifier has been pumped to a high gain state. When the fluorescence from the active medium becomes intense enough, the energy that the dye absorbs causes the dye to be “transparent” at the laser wavelength. Now the dye cell is “bleached” and no longer represents a high cavity loss to the laser. The “bleaching” of the dye is the equivalent of Q-switching in the laser, and it can occur in a period smaller than a nanosecond.

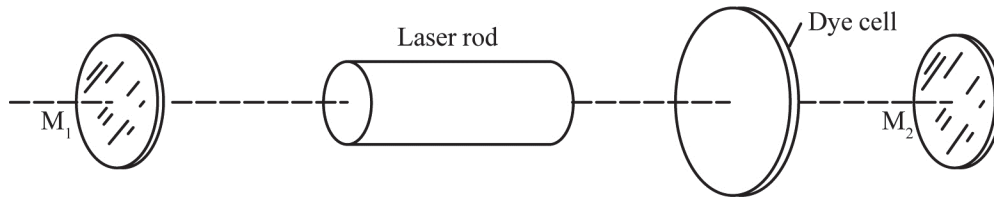

Figure 1-10 *Bleachable-dye Q-switch*

Bleachable dye Q-switches rate very high in dynamic loss (>99%) and insertion loss (a few percent at most), and their switching time is fast. They have virtually no synchronization at all. Dye cell Q-switches can be used only with pulse pumped systems because a CW pumped laser never produces sufficient fluorescence to bleach the dye.

Current Uses and Applications of Q-Switches

In the early days of laser technology, both mechanical Q-switches and bleachable dyes were widely used. But because of the slower speed of mechanical devices and because the spatial profile of the beam with bleachable dye devices was poorer than with other Q-switches, these Q-switches are not widely used in modern lasers, although a technician may still encounter them on older lasers.

In modern lasers, either electro-optic or acousto-optic devices are employed. Acousto-optic Q-switches are the most widely used and are very often used with Nd:YAG lasers. When the highest possible peak power is desired, an electro-optic Q-switch is used.

Q-switched lasers are used in applications that require high peak power in nanosecond durations. For some applications in materials processing, a short pulse does not allow heat to be conducted into a workpiece, and thus prevents unwanted damage. Nonlinear optics, to be discussed later in this module, can take advantage of the high values of peak power needed for nonlinear optical excitation. Q-switched lasers have been used in remote distance measurements: distances can be calculated by measuring the time from when the laser is fired until a return reflected from a target is detected. The resolution of the measurement is improved by using a shorter pulse. In the medical realm, Q-switched lasers are often used to remove tattoos. They can shatter tattoo pigments without causing excessive damage to nearby tissue.

Summary of Q-Switching

Q-switching is a method of obtaining high-peak-power, short-duration laser pulses by controlling the loop gain of the laser cavity. A Q-switch is essentially a very fast shutter located

between the active medium and the HR mirror. This shutter is closed during pumping to reduce the loop gain to zero and prevent lasing. Since there is no lasing to deplete the population inversion, energy stored in the active medium and amplifier gain both reach high values. The Q-switch shutter is then opened, producing a very high loop gain. The resulting high-intensity standing wave uses most of the energy stored in the laser active medium to produce one large pulse.

A good Q-switch should reduce the loop gain to zero when closed and should introduce no loss in the cavity when opened. It should switch from one condition to the other as fast as possible, and the switching should be synchronized to external events. No single Q-switch rates high in all four of these prime characteristics. The type chosen for any specific application depends on the type of laser used and system output requirements.

Mode Locking: Generating Ultrashort Laser Pulses

We turn now to mode locking, a method for producing ultrashort pulses with duration even shorter than Q-switched pulses. By *ultrashort* pulses, we mean pulses that typically have durations in the picosecond (10^{-12} s) to femtosecond (10^{-15} s) range, although they may be even shorter. Q-switched pulses typically have durations in the nanosecond range.

A Particle Description of Mode Locking

Mode locking is very similar to Q-switching. In Q-switching, a device is inserted into the laser cavity that reduces its loop gain for a set period of time. In this condition, the population inversion within the active medium continues to increase, thus increasing the stored energy in it. Typically, a Q-switch keeps the gain within the cavity low for an amount of time equivalent to several photon round-trips within the laser cavity. Similarly, in mode locking, a device is inserted into the cavity that reduces its loop gain, but in this case, the device only reduces loop gain for the amount of time that it takes photons to make one round-trip of the laser cavity. Most intracavity devices that are used for Q-switching can also be used for mode locking, as long as they can be cycled from low to high gain fast enough to meet this round-trip time criterion.

You can think of the intracavity mode locking device as a gate. The gate opens just as a packet of photons approach it, and it stays open just long enough for these photons to pass through the gate, reflect off the HR mirror, and pass through the gate going in the opposite direction. After this packet of photons has cleared the gate, the gate closes and blocks all other photons from getting to the HR mirror. The gate stays closed until that packet of photons reflects off the output coupler mirror and returns to the gate (completing a round-trip of the laser cavity). The gate then opens again, and the cycle repeats itself. Only this one packet of photons gains energy in the laser cavity, while the energy of other packets decreases. The net effect is a pulse of photons bouncing back and forth inside the laser cavity and an output from the laser that consists of pulses.

Though this picture of photons moving back and forth in the laser cavity is descriptive, mode locking is best described from a wave perspective.

Mode Locking from a Wave Perspective

You have already learned that a laser cavity contains a number of electromagnetic standing waves called *longitudinal modes*. For these modes to exist within the laser cavity, the mirrors must be separated by an integral number of half-wavelengths. This can be represented by Equation 1-8, and seen in Figure 1-11.

$$q = 2nL/\lambda \quad (1-8)$$

where q is a large integer, L is the distance between the mirrors, n is the index of refraction of the material between the mirrors, and λ is the wavelength. For each value of the integer q , there will be a component of the laser output with a slightly different wavelength. Each of these components is called a longitudinal mode. The frequency spacing between two modes with integer values q and $q + 1$ is given by Equation 1-9.

$$\Delta\nu = \frac{c}{2L} \quad (1-9)$$

Where c is the speed of light.

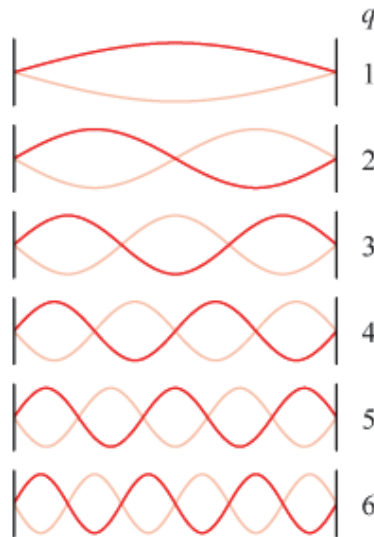

Figure 1-11 *Longitudinal modes in a cavity*

Mode locking can arise because light waves corresponding to the different modes are bouncing back and forth between the laser mirrors. These light waves can interfere constructively and destructively with each other. If the different waves have a *fixed phase relationship* with each other, they can periodically constructively interfere with one another. This produces an intense burst of light. When this occurs, the laser is said to be mode locked. The timing of the intracavity gates described in the previous section causes longitudinal modes within the laser cavity to develop a fixed-phase relationship with each other. For mode locking to occur, these gates must be timed to cycle the cavity gain between high and low values in a time period equal to the round-trip transit time of photons in the laser cavity. When these gates have this timing, and only this timing, a fixed-phase relationship is established among the longitudinal modes in

the cavity. With this fixed-phase relationship, mode locking occurs, and the output of the laser becomes pulsed. The specific process by which the timing of these gates causes this fixed-phased relationship is complex to explain and beyond the scope of this module. Note also that a laser that has been constrained to operate in a single longitudinal mode cannot be mode locked. Figure 1-12 compares the output of a laser whose modes are in phase with output from a laser whose modes are randomly phased.

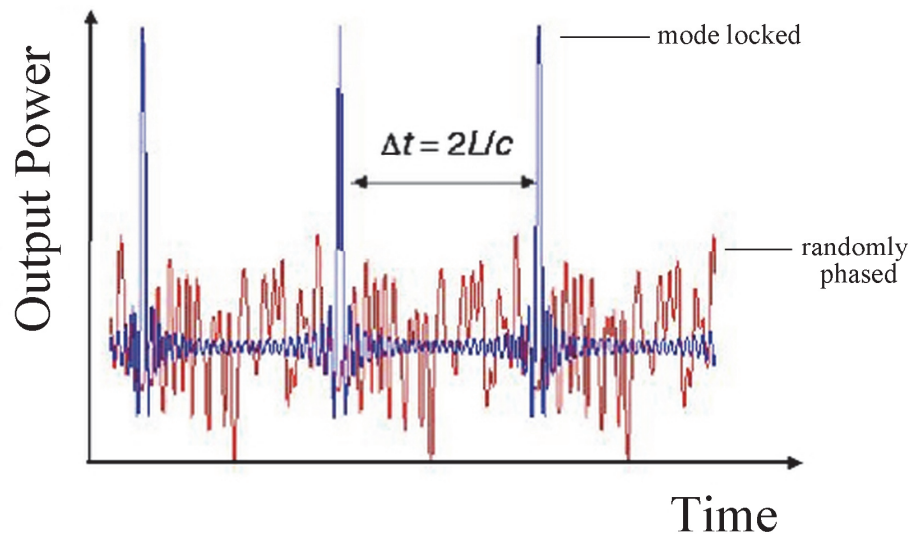

Figure 1-12 Mode locked and random phased laser output

It should now be clear what differentiates Q-switching from mode locking: timing. In Q-switching, the intracavity device that controls the process can keep the laser cavity in a low gain situation for as long as the net energy gain of the active medium keeps increasing. In mode locking, the amount of time that the intracavity device keeps the laser cavity in a low gain situation is fixed and based on the round-trip time of the photons in the laser cavity.

The time spacing, τ , between the pulses generated from mode locking is equal to the round-trip transit time of the pulse and is given by Equation 1-10.

$$\tau = \frac{2L}{c} \quad (1-10)$$

Thus, for a ruby laser with $n = 1.76$ and with the ruby filling the 5 cm space between the mirrors, the spacing of the mode locked pulses is about 0.59 ns.

The duration of the mode locked pulses is determined by the number of modes that have a fixed-phase relationship. The greater the number of modes, the shorter will be the pulse duration. It can be shown that the pulse duration for a laser oscillating in N longitudinal modes separated in frequency by a spacing $\Delta\nu$ is approximately given by Equation 1-11.

$$\text{Minimum Pulse Duration} = \frac{.44}{N\Delta\nu} \quad (1-11)$$

As you already know, the emission lines of lasers are not typically sharp lines, but instead are spread out—broadened—over a range of energies (often called the spectral width). The wider the emission lines of the active medium, the greater the number of modes of oscillation that are generated inside a laser cavity. According to Equation 1-11, this increase in modes will generate shorter pulse durations. For example, with the Ti:sapphire laser, which has a spectral width around 1.3×10^{14} Hz, the above approximation predicts a minimum pulse duration around 3.4 femtoseconds.

Active and Passive Mode Locking

We have generically described a mode locking device as like a gate. Let's now describe some specific devices that are used for mode locking.

Mode locking may be produced by either active or passive means. Active methods use an external signal to modulate the light within the laser cavity. Passive mode locking involves introducing some material (such as a bleachable dye) into the cavity to cause the light to become self-modulated.

Both acousto-optic and electro-optic modulators have been used for active mode locking. In what is probably the most common method of active mode locking, an acousto-optic modulator inside the laser cavity sinusoidally amplitude modulates the light in the cavity. The modulator acts like a shutter for the light bouncing between the mirrors. The modulator lets light through when it is open and attenuates the light when it is closed. The modulation period is synchronized with the round-trip transit time of light in the laser cavity, so that a single pulse of light bounces back and forth in the cavity.

The most common type of passive mode locking is the use of saturable absorbers, such as bleachable dyes like those used for bleachable dye Q-switching. In fact, a laser may be simultaneously Q-switched and mode locked by the same dye. The transmission of a dye placed in the cavity will be affected by the light intensity within the cavity. This change in transmission will then react on the light circulating in the cavity. The dye acts as a modulator: at first, it absorbs and thus blocks the leading edge of the pulse; then, as the absorption of the dye is saturated, the remainder of the pulse passes through without attenuation. In addition to dyes, semiconductors have sometimes been used as saturable absorbers.

Originally, passive saturable absorbers were used for mode locking. But in modern lasers, active techniques are used. Active techniques offer better control and more reproducible pulses.

Our earlier discussion centered on mode locked pulses occurring in a train of multiple pulses. But it is possible to extract a single pulse from such a train by inserting a high-speed deflector in the beam and activating it in the interval between pulses.

Ultrashort Pulse Lasers

As Equation 1-11 showed, to produce ultrashort pulses, one needs a laser made of material that has a broad emission spectrum. The first material in which serious research was done to produce ultrashort pulses was Nd:glass, which has broad emission lines. This was superseded by the use

of liquid dye lasers, which have even broader emission spectra. For a number of years, the generation of ultrashort pulses with durations in the subpicosecond range, was dominated by liquid dye lasers. Many dye lasers capable of producing ultrashort pulses are still in use. In recent years, however, Ti:sapphire lasers are more commonly used to generate ultrashort pulses because they have an extremely broad emission spectrum. As we saw earlier, if the full width of the emission spectrum of a Ti:sapphire laser is used, the resulting pulse can be as short as a few femtoseconds. And in more recent times, lasers using ytterbium doped optical fibers have pushed into the femtosecond regime also. A technician could encounter a variety of different lasers with ultrashort capabilities, ranging from picoseconds down to femtoseconds.

In research demonstrations, the shortest pulses produced by mode locked Ti:sapphire lasers have been about 5 fs long. These have been produced by lasers that have been actively mode locked with an electro-optic element.

It is possible to produce even shorter pulses using advanced techniques, but a description of these techniques is beyond the scope of this module. Researchers have produced pulses as short as 0.1 fs (100 as; an attosecond is 10^{-18} s), but so far, pulses this short have only been produced in research demonstrations.

Laser manufacturers offer many models of ultrashort pulse Ti:sapphire lasers, as well as fiber lasers with pulse durations in the 100 fs range. The shortest commercially available pulse duration is 5 fs.

Applications of Ultrashort Pulse Lasers

One of the leading applications for ultrashort lasers has been in photochemistry. The pulses are used to probe chemical reactions and to determine the nature of short-lived intermediate molecules during the course of a complex chemical reaction. The availability of ultrashort laser pulses has allowed the dynamics of chemical reactions to be studied on a time scale not possible before.

Laser materials processing has benefited from the availability of ultrashort pulses. Micromachining can be done on small parts in a time so short that there is essentially no flow of thermal energy in the part. The beam from a sharply focused ultrashort pulse laser can produce nonlinear effects inside the target material and can change the properties of the material on a scale smaller than the wavelength. Thus, ultrashort pulse lasers have been used to create gratings and other patterns with very high resolution.

Ultrashort pulse lasers have also been used in medical applications to generate very fine patterns, like in other materials processing applications. They have been studied for corneal surgery and some skin treatments.

Such lasers have also been used to measure the temporal characteristics of electronic devices with very high resolution. Examples include measurements of processing functions in integrated circuits and semiconductor devices.

This list gives only a small sample of the types of applications that have been studied for ultrashort pulse lasers.

Summary of Ultrashort Pulse Lasers

Over the last few decades, the duration of the shortest pulses of laser light has steadily decreased, from the nanosecond range in the 1960s to the femtosecond range now, and there are prospects of moving into the attosecond range. Such pulses are produced by mode locking, which locks together the phases of a number of longitudinal modes of the laser in a fixed relationship. Mode locking may be active or passive; active mode locking uses an external modulator, while passive mode locking uses a bleachable dye. The materials used for mode locking have progressed: liquid dyes were used for a number of years, while now, Ti:sapphire lasers and fiber lasers are more common. Applications for ultrashort pulses are emerging.

Frequency Doubling in Nonlinear Materials

Nonlinear optical materials are materials in which the intensity of the light, including its frequency, is not related to the intensity of the light output by a simple proportionality constant. Because of this nonlinear behavior, an intense light beam propagating through a nonlinear optical material will produce new effects that can't be seen with weak light beams. For example, an intense light beam propagating through a nonlinear material can generate harmonics, or overtones, of the original light frequency. A harmonic has a frequency that is an integral multiple of the frequency of the original beam. In particular, the second harmonic can be generated. This means that the frequency of the beam can be doubled. The red beam from a ruby laser can be changed to an ultraviolet beam.

This module will familiarize you with the fundamental physical ideas that underlie some of the more commonly encountered nonlinear phenomena and the ways that these phenomena depend on the properties of the nonlinear materials. The experiment at the end of this module will give you practical experience in using a nonlinear material to generate the visible second harmonic of the invisible 1.06- μm Nd:YAG laser wavelength.

Linear and Nonlinear Behavior of Physical Phenomena

Our objective is to develop a familiarity with the behavior and application of nonlinear materials. We'll do this by first describing the behavior of a linear system or material. Next, we'll look at its nonlinear behavior and discuss the internal properties of the material that make it behave in a nonlinear fashion. Finally, we'll describe in a very elementary fashion the fundamental physical idea behind one of the more common nonlinear effects and how this effect depends on the properties of the nonlinear material. We conclude this section with a brief discussion of the more common nonlinear materials.

Let's start, then, with a brief discussion of linear materials and linear effects. Our everyday experiences tell us that we live in an essentially linear world. When you first encounter the mathematical expressions of elementary physical laws, you may be tempted to conclude that nature is linear. For example, you learn that gas pressure in a container will double if the temperature of the gas is doubled; or that if a given force stretches a spring one centimeter, then doubling the force will stretch it exactly two centimeters. The example of the spring is shown schematically in Figure 1-13.

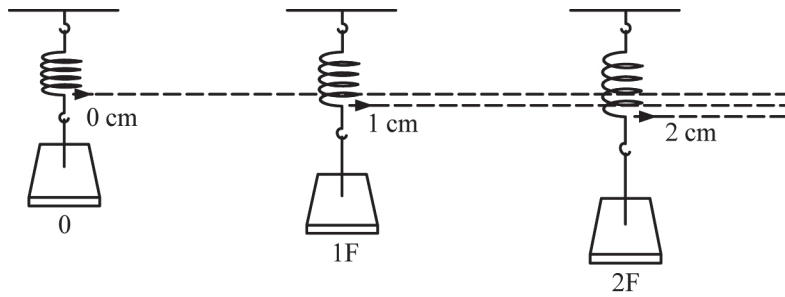

Figure 1-13 *Linear displacement of a spring*

From these and other examples, you may conclude that the response to small disturbances in all physical systems follows a linear law. Doubling the cause doubles the effect, tripling the cause triples the effect, and so on.

Consider once more the linear spring. The mathematical expression relating the force F on the spring to the stretching of the spring in the x direction is where the proportionality constant k is the spring constant.

$$F = kx \quad (1-12)$$

In practice, as long as the stretching of the spring is small compared to the total length of the spring, the force can be calculated with Equation 1-12. However, when the distance through which the spring is stretched exceeds a certain limit, the magnitude of the force F no longer is related to the distance x in a simple linear manner. Then it's more accurately expressed by the nonlinear equation

$$F = kx + k'x^2 + k''x^3 + k'''x^4 + \dots \quad (1-13)$$

where k' , k'' , and k''' are higher-order constants and are much smaller than the constant k .

The magnitude of the force as a function of the distance the spring is stretched is shown in Figure 1-14, which illustrates the linear as well as the nonlinear behavior of the spring.

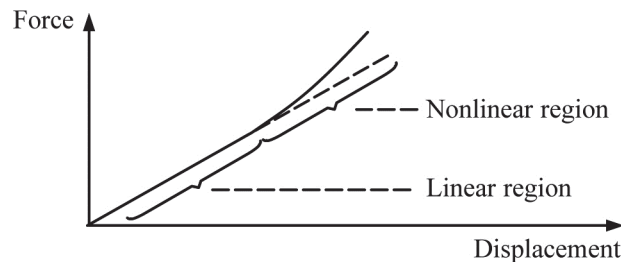

Figure 1-14 *Linear and nonlinear behavior of a stretched spring*

Now we've stated what we mean by *linear* and *nonlinear* behavior of a system (the spring). Let's next discuss the nonlinear behavior of certain materials when intense light beams propagate through them. These light beams are electromagnetic waves made up of an electric

field and a magnetic field. These two fields are locked in step at right angles to each other and oscillate together at the frequency of the light.

Consider what happens when such an oscillating field interacts with an atom, which you can think of as a positively charged nucleus surrounded by a shell of electrons. The electrons in the outermost shell are more loosely bound than those closer to the nucleus. When an electromagnetic wave passes near an atom, the wave's electric field, E , redistributes the charges in the atom, especially the negatively charged electrons in the outermost shell. Figure 1-14 shows the effect of an electric field on the charge distribution of an atom.

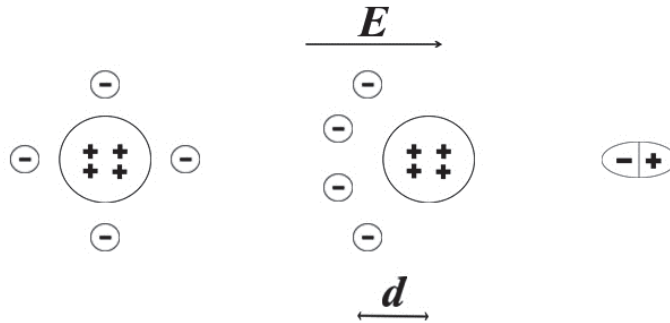

Figure 1-15 *Generation of a dipole*

The image on the left in Figure 1-15 gives an example of how charge can be distributed in an atom when no external electric field is applied. The middle image illustrates (in a very exaggerated way) how an external electric field can redistribute charge in an atom. In effect, the external electric field separates the charge into distinct regions of positive and negative charge. Based on these results, we define two equal and opposite charges that are separated by some distance as a *dipole*. The middle image in Figure 1-15 is an example of a dipole. The image on the right shows the symbol that represents a dipole. To characterize a dipole, we use a quantity called the *dipole moment*, which is the product of the displaced charges times the distance between the positive and negative centers of charge. For Figure 1-15, the dipole moment equals qd , where q is the amount of charge that is displaced and d is the distance between the positive and negative centers of charge.

The number of electric dipoles per unit volume multiplied by the dipole moment of one atom gives the induced macroscopic charge polarization of the material. Don't confuse this charge polarization induced by the electric field of the light beam with the polarization of a light beam caused by a polarizing filter.

In any given material, the magnitude of the induced charge polarization depends on the magnitude of the applied electric field E . Specifically, we can express the charge polarization P in terms of a series of powers of E :

$$P = \alpha E + dE^2 + d'E^3 \tag{1-14}$$

where: α = Polarizability coefficient of the material
 $d, d',$ etc. = Higher-order nonlinear optical coefficients that are much less than α .

The similarity between Equation 1-14 and Equation 1-13 should be clear. The polarizability, α , in Equation 1-14 is analogous to the spring constant, k , in Equation 1-13. While k is a measure of how susceptible a material is to being stretched, α is a measure of how susceptible a material is to being polarized.

The electrons in the outermost shell are subject not only to the pulling of the applied external field, but also to the pull of the internal field, due to the positive nucleus. The magnitude of this internal electric field is enormous—somewhere in the neighborhood of 10^9 V/cm. By comparison, the electric field of sunlight at the surface of the earth is only about 10 V/cm. It turns out that when the applied electric field is many orders of magnitude less than the atom's internal electric field—which is always the case for ordinary light sources—the linear approximation $P = \alpha E$ of Equation 1-14 is very accurate. This is similar to staying within the linear region of the spring.

With the development of the laser in 1960, we were able to build light sources capable of producing optical electric fields of 10^6 to 10^7 V/cm. When such intense fields irradiate some optical materials, the contribution to the charge polarization by the higher-order terms in Equation 1-14 can no longer be neglected. This is the same type of effect we saw when the spring displacement entered into the nonlinear region in Figure 1-14.

If the electric field that generates dipoles is from an electromagnetic wave, the magnitude of this field will constantly be changing with time. This changing electric field causes the dipoles to oscillate. As the electric field increases in time, the charges in the dipole move further apart, and as the electric field decreases, the charges move closer together. Whenever dipoles oscillate, they produce electromagnetic waves that have a frequency equivalent to the frequency of the electric field causing the oscillations. Thus, oscillating dipoles can generate light.

Let's see what kind of light these dipoles can generate when an electromagnetic wave from a laser oscillates them. Instead of deriving this result, we will present the starting point of the derivation, explain some assumption and steps in the derivation, and provide the final result. Since a laser generated the electromagnetic wave, its electric field strength will be sufficient to cause some nonlinear effects in terms of polarization. To accurately model these effects, we start with Equation 1-14 and include both the linear term and the first nonlinear term.

$$P_x = \alpha E_x + dE_x^2 \quad (1-15)$$

We also assume that the electric field of the electromagnetic wave causing the polarization is always pointing in the x direction, as indicated by the subscript x in Equation 1-15. Next, we write the electric field E_x as a function that varies in time with an angular frequency of $\omega \equiv 2\pi f$. After some algebra and a trigonometric substitution, we get the following final result:

$$P_x = P_x(\omega) + P_x(2\omega) + \text{constant term (DC)} \quad (1-16)$$

An inspection of the above equation reveals that the first term $P_x(\omega)$ is a charge polarization of angular frequency ω . The second term $P_x(2\omega)$ is a charge polarization of angular frequency 2ω , twice the fundamental frequency ω . Finally, the third term has no frequency dependence whatsoever. It provides a “DC” charge polarization. The three charge polarization terms are shown in Figure 1-16, below. Equation 1-16 tells us that a rapidly oscillating electric field in the

neighborhood of 10^{14} to 10^{15} Hz (optical frequencies) will induce two types of oscillating charge polarizations within a material: one of frequency $\omega/2\pi$ and another of frequency ω/π . As a result, these oscillating dipoles will absorb and reradiate light waves that have one frequency ($\omega/2\pi$) equal to the electromagnetic wave that caused the oscillations, and another (ω/π) that is twice this frequency.

One effect of the induced charge polarization and subsequent reradiation is a decrease in the speed of the light in the medium. The decrease in speed is reflected in the increased value of the index of refraction n , which is given by the ratio of the speed of light in vacuum c divided by the speed of light in the medium v :

$$n = \frac{c}{v} \quad (1-17)$$

Second Harmonic Generation

Equation 1-16 predicts a very important effect: the reradiation of energy at the frequency ω/π , twice the frequency of the incident radiation. This doubling of frequency is known as *second harmonic generation* (SHG) or *frequency doubling*.

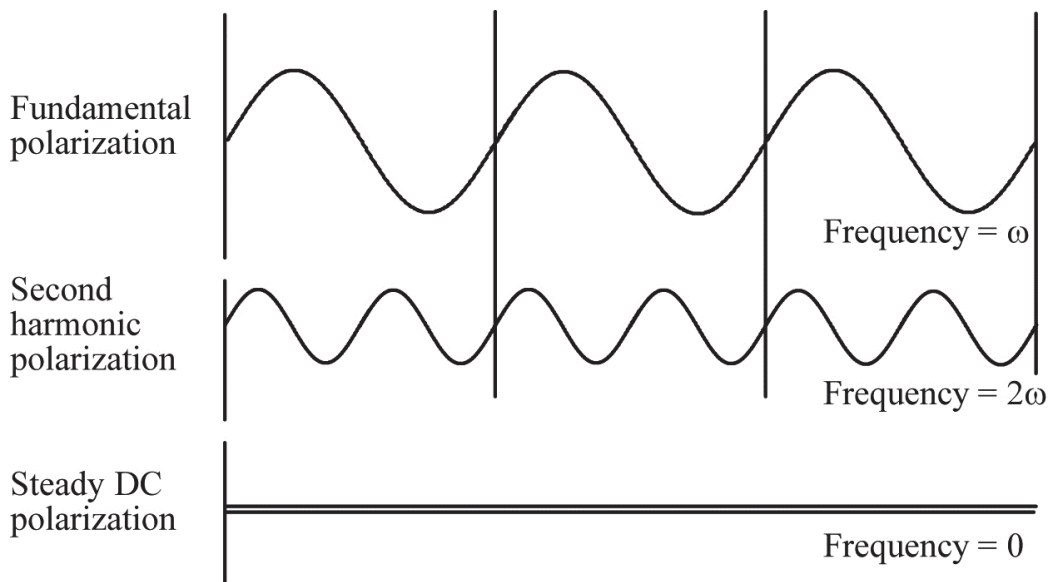

Figure 1-16 Frequency associated with charge-polarization term

Frequency doubling was observed for the first time in 1961 by Professor Peter Franken and some graduate students at the University of Michigan. They irradiated a quartz crystal with the beam from a ruby laser that operated at 694.3 nm. A very small amount of the light striking the crystal was converted to light with a wavelength of 347.2 nm. This wavelength lies in the ultraviolet region of the spectrum and is of course exactly half the wavelength and twice the frequency of the incident laser light.

The details of this famous experiment are shown in Figure 1-17. As you might expect, this experiment initiated a search for materials in which this effect occurs strongly. As a result, second harmonic generation has been commonly used for different laser systems with different nonlinear materials.

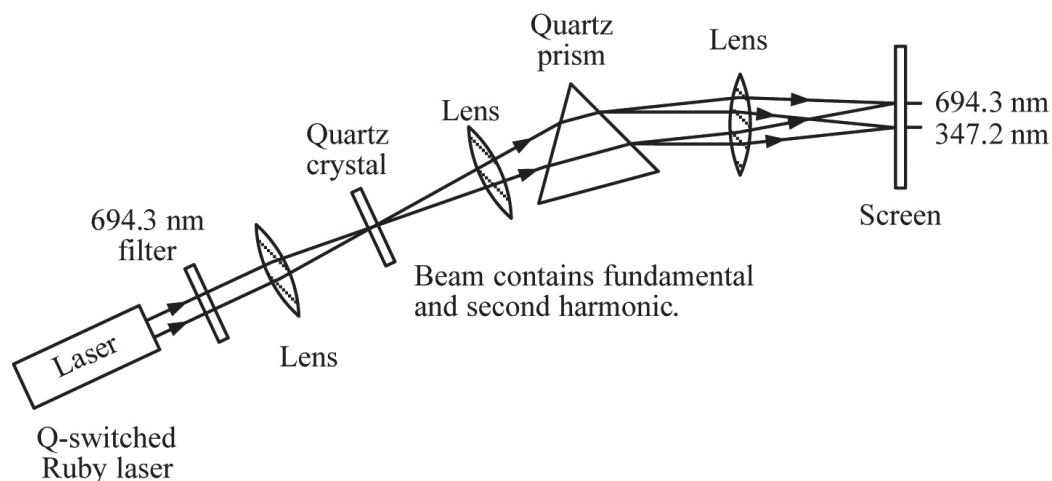

Figure 1-17 *Experimental arrangement for second harmonic generation*

Since this time, frequency doubling has become a very important research topic. Scientists have studied many approaches for increasing the efficiency of SHG. They have studied the properties of crystals that are responsible for efficient SHG. As a result, frequency doubled lasers have become very common and are sold commercially by many vendors.

Other Nonlinear Optical Effects

Now let's turn our attention from SHG, which was the first nonlinear effect observed with a laser beam, to some other important nonlinear effects. These effects can be cataloged into two groups, passive and active, depending on the nonlinear material used.

Materials that produce *passive* optical effects are those that act essentially as catalysts without imposing their characteristic internal resonance frequencies onto the particular nonlinear effect. Passive nonlinear effects include harmonic generation, frequency mixing, optical rectification, and self-focusing of light.

Materials that produce *active* nonlinear effects do impose their characteristic resonance frequencies onto an incident beam of light. These active materials produce the optical nonlinear effects of two-photon absorption and stimulated Raman, Rayleigh, and Brillouin scattering.

Nonlinear Optical Materials

We now consider some of the important materials used in nonlinear optical applications. Because scientists want to apply the many different nonlinear effects, they have learned how to find these nonlinear materials and also how to calculate and predict their properties.

We won't discuss all the numerous nonlinear materials, but will describe a few of the more important ones.

ADP and KDP ($NH_4H_2PO_4$ and KH_2PO_4)

Ammonium dihydrogen phosphate (ADP) and potassium dihydrogen phosphate (KDP) were among the first nonlinear crystals used to generate second harmonic light. Because of their similarity, we'll discuss them together.

Both materials were first used in piezoelectric applications such as ultrasonic transducers. Since these materials are easy to grow in aqueous solutions that produce high-optical-quality single

crystals, you can purchase specimens as large as 10 cm on one side. The optical transmission band extends from the ultraviolet to the near infrared, typically 200 nm to 1500 nm.

ADP will deteriorate when heated to temperatures over 100°C and has a tendency to crack upon cooling. But KDP is relatively stable and can be heated and cooled. Both materials are sufficiently resistant to laser damage for most applications.

Isomorphs, which are substances of different chemical composition that crystallize in the same form as ADP or KDP, have also been used to produce nonlinear optical effects. The best-known of these is deuterated KDP (in which the two hydrogen atoms are replaced by deuterium) which is designated KD*P and called: "K-D-star-P." The shortcomings of KDP and ADP are a relatively small nonlinear coefficient, which is a measure of the efficiency with which light is frequency doubled, and poor optical transmission in the infrared region of the spectrum. They are not used widely in modern applications.

Lithium Niobate (LiNbO₃)

This material, commonly abbreviated “LN,” is one of the more important of the nonlinear materials that have appeared in recent years. It’s transparent from 400 nm to 5 μm, and its nonlinear coefficient is about ten times larger than that of KDP. This means that lithium niobate is two orders of magnitude more efficient than KDP and that SHG efficiencies close to 100 percent are possible. It's one of the few nonlinear materials available in large sizes in commercial quantities.

Crystals are available in sizes up to a few centimeters in diameter and more than 10 centimeters in length. The crystals are clear as water and insoluble in water. This material is used in second harmonic generation and a host of other applications.

One problem with lithium niobate is that it has a very low damage threshold. In some samples, this damage disappears by itself soon after the laser beam is turned off. But in other samples, the characteristic “tracks” can remain for days. Fortunately, the damage can be reversed by heating the crystal to about 200°C.

Beta Barium Borate (BBO) and Lithium Triborate (LBO)

Beta barium borate (β -BaB₂O₄ or BBO) and lithium triborate (LiB₃O₅ or LBO) are nonlinear optical crystals. They were introduced in the late 1980s and accelerated NLO development significantly because they have many unique features. Both materials are transparent well into the ultraviolet range, and both have a broad transparency range up to 2.6 μm. Other features include large nonlinear coefficients (3 to 6 times that of KDP), high damage thresholds, and good optical properties. Of all commonly used NLO crystals, lithium triborate has the highest damage threshold, making it the material of choice for high-average-power applications and research and development of advanced laser systems such as all-solid state wide-tunable lasers, ultrafast pulse lasers, and deep ultraviolet (deep UV or DUV) lasers.

BBO is frequently used to frequency double visible light to reach the ultraviolet range.

Barium Sodium Niobate (Ba₂NaNb₅O₁₅)

This nonlinear material—which also is known as “banana”—is similar to lithium niobate. But it doesn't suffer as much from optical damage when it is maintained at a temperature above room

temperature. Barium sodium niobate has a nonlinear coefficient that's about three times larger than that of lithium niobate.

$Ba_2NaNb_5O_{15}$ is optically transparent from 370 nm to about 5 μm . Some samples don't have good optical quality due to marked brown discoloration. This material has been used for very efficient generation of the second harmonic of 1.06 μm radiation and to build parametric oscillators.

Potassium Titanyl Phosphate (KTiOPO₄ or KTP)

This material is transparent from 0.19 to 2.5 μm . It has a large nonlinear coefficient and is widely used in modern frequency doubled lasers, especially for doubling Nd:YAG lasers to produce green light.

Proustite (Ag₃AsS₃)

Proustite is a naturally occurring crystal found in mineral deposits. It also can be produced synthetically. The one characteristic that distinguishes this material from all other nonlinear materials is its transmission band, which extends from about 600 nm to beyond 13 μm . The coefficients that measure its efficiency at producing nonlinear effects are relatively large. In fact, they are about 300 times larger than the analogous coefficients of KDP.

The material has been used in experiments that involve mixing the 10.6 μm radiation from a CO₂ laser with a visible laser. Proustite crystals of good optical quality and dimensions of several centimeters are grown in an aqueous solution. Some disadvantages of this material are its inability to accept coatings and its resistance to optical polishing.

Aside from the few materials listed above, a host of other materials are available to the experimenter, and new nonlinear materials are constantly being added to the already large list.

Damage

Intense sources of light are required to produce second harmonics and other nonlinear optical effects. Because of this, technicians often have to irradiate material at levels that are close to the level at which the material is subject to optical damage. The technician must consider the potential for damaging a crystal. Damage may require the replacement of the crystal, which can be expensive. Table 1-2 provides estimates of the damage thresholds of some common SHG crystals.

Table 1-2. Approximate Damage Thresholds for Common SHG Materials at $\lambda_o = 1.06 \mu\text{m}$ for Q-switched Operation

Material	Approximate Damage Threshold in (GW/cm^2)
ADP	0.50
BBO	5 (10 ns) 10 (1.3 ns)
$\text{Ba}_2\text{NaNb}_5\text{O}_{15}$	0.001
KDP	5
KD*P	3
LBO	18.9
LiNbO_3	0.1
LiIO_3	0.05
KTP	0.5

As the technician is setting up equipment for a nonlinear optics application, he or she should estimate the power per unit area expected at the surface of each element and compare that figure to the numbers above. The technician should ensure that the nonlinear optical materials are not likely to be damaged.

LABORATORY

Laboratory 2-1 Diode Pumped Q-switched and Frequency Doubled Nd:YAG Laser Lab

Purpose

In this laboratory, you will complete the following tasks:

- Use proper laser-safety practices when operating Class 4 IR lasers
- Use the equipment manufacturer's user manual to set up, run, and characterize the diode laser pump of an Nd:YAG laser
- Use the equipment manufacturer's user manual to set up, run, and characterize a diode pumped Nd:YAG laser.
- Use the equipment manufacturer's user manual to set up, run, and characterize a diode pumped frequency doubled Nd:YAG laser
- Use the equipment manufacturer's user manual to setup, run and characterize a diode pumped Q-switched Nd:YAG laser.

Safety Precautions

Both the diode laser (output at 808 nm) used as the optical pump source and the solid state Nd:YAG laser (1.06 nm) are classified as Class 4 lasers. Appropriate laser safety goggles (OD = 6 – 7 at 1064nm, 808nm, and 532 nm) must be worn while these lasers are in operation to prevent eye damage, and all laser safety rules pertaining to these lasers must be observed. Your instructor will provide the goggles and an overview of these safety rules. Do not operate these lasers without fully understanding the safety rules and precautions associated with them.

Equipment

1. PI miCos Laser Education Kit CA -1230 user manual
2. PI miCos Nd:YAG laser (Laser Education Kit CA-1230)
3. PI miCos Nd:YAG laser option for frequency doubling
4. PI miCos Nd:YAG laser option for active Q-switch
5. Optical power meter (up to 500 mW) and head
6. Laser safety goggles (Minimum OD = 6-7 at 1064 nm, at 808 nm and at 532 nm)
7. Helium-Neon laser (1 mW) with adjustable mount
8. A fast photodiode (rise time of 5 ns or less)

9. A fast oscilloscope (bandwidth of at least 200 MHz)
10. An IR detection card and an IR viewer or IR converter screen

Pre-Lab Familiarization

This laboratory will require students to set up, operate, and characterize a PI miCos diode pumped actively Q-switched frequency doubled Nd:YAG laser. Primary directions for performing these tasks will come from the user manual that accompanies this laser. Before beginning this laboratory, students should familiarize themselves with this manual, placing particular emphasis on chapters 1 – 4. Figure 1-18 is a drawing, copied from this user manual, of the basic laser set-up used in this laboratory. It is replicated here for quick reference.

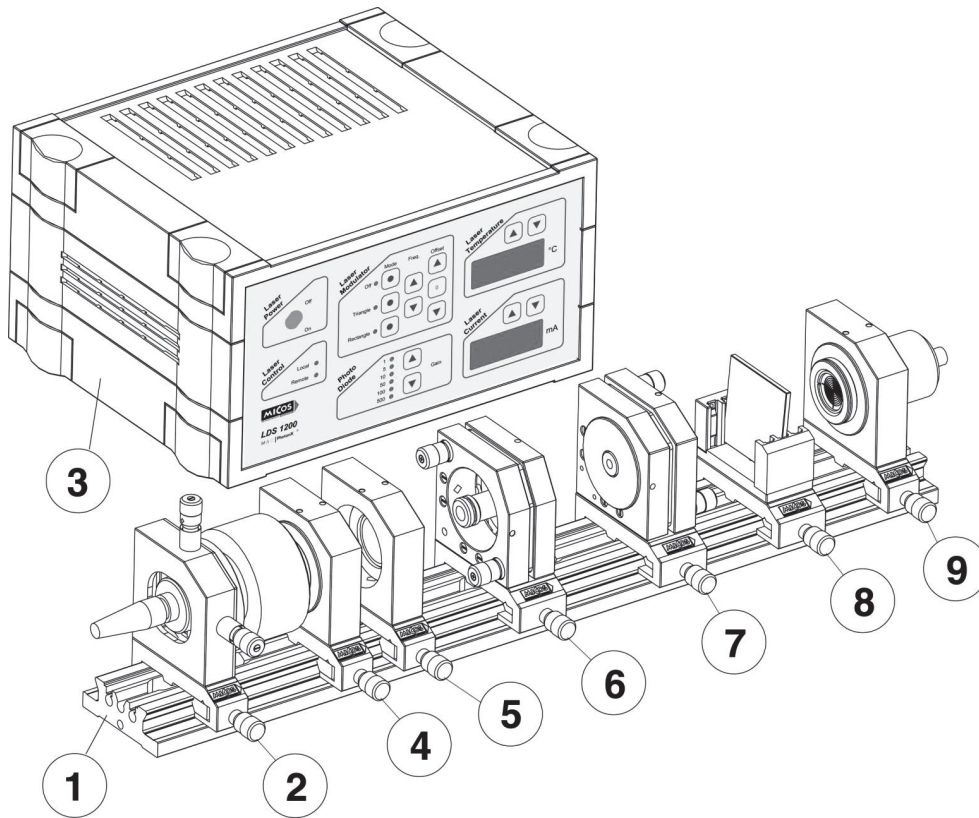

Figure 1-18 Experimental setup and components of a diode pumped Nd:YAG laser. Part 1: Flat rail 500 mm with scale; Part 2: Laser diode 450 mW in X-Y adjustment holder; Part 3: Diode laser power supply LDS 1200; Part 4: Beam shaping optics in holder on carrier; Part 5: Beam focusing in holder on carrier; Part 6: Nd:YAG crystal in holder adjustable on carrier; Part 7: Laser mirror holder adjustable on carrier; Part 8 Filter holder on carrier with filter RG1000; and Part 9: Photo detector in holder on carrier and an adjustment target. (Courtesy of PI miCos)

Procedures

1. Read section 4 of the PI miCos (PM) user manual to learn the proper procedures for operating the laser diode power supply.
2. Follow the directions in section 3.1 – 3.2 of the PM user manual to set up the diode laser pump depicted in Figure 1-18.

3. Make the following measurements of the diode laser.
 - a) Check the specification sheet to find out the maximum allowed current for the diode laser. Record the maximum current here: $I_{\max} = \underline{\hspace{2cm}}$ mA. To avoid permanent damage to the diode laser, do not exceed this maximum current.
 - b) Remove the PM photodiode from the rail assembly.
 - c) Turn on the optical power meter. Set the power meter close to the laser diode, so that the all light from the laser diode goes directly through the power meter's aperture and is incident on the detector's sensitive area. Do not move any part of this set-up once you have assembled it. If you move it, you may change the background radiation level entering the detector and introduce inconsistency into your measurements.
 - d) Turn on the power supply that is connected to the diode laser. Slowly change the current applied to the laser diode.
 - e) Record the **current** (in mA) and **measured light power** (in mW) in Data Table 1. Add the drive current in small increments, starting at zero and increasing until it reaches the maximum current specified for this laser diode. Record your measurements in Data Table 1.

Data Table 1. Diode Laser Current and Power

Drive Current I (mA)	Measured Optical Power P (mW)

- f) Switch off the optical power meter and move it away. Use an IR detection card to observe the laser output around the threshold current found in the Data Table 1.
- g) Turn off the diode laser power supply.
- h) Figure 1-19 shows an example of an I-P curve. On the curve, we can define the diode laser threshold as well as the slope efficiency. Once the laser reaches its threshold, the laser output increases linearly as the drive current increases. As indicated in the

figure, the threshold current is approximately 160 mA, and the slope efficiency is about 0.12% mW/mA.

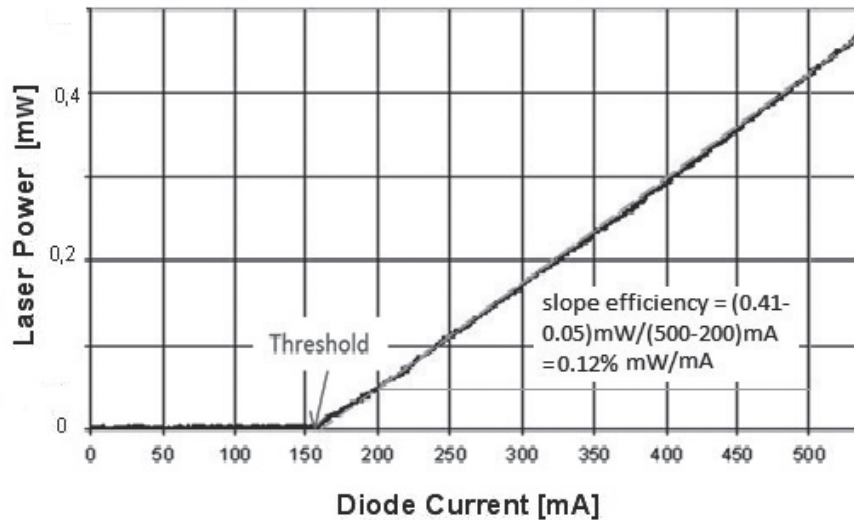

Figure 1-19 An example of the diode laser optical output power versus drive current

- i) From the recorded data in Data Table 1, plot the **reading of the power meter vs. drive current**.
 - j) From the I-P graph, find:
 - The laser threshold current $I_{th} = \underline{\hspace{2cm}}$ mA.
 - The laser slope efficiency $\eta = \underline{\hspace{2cm}}$ mW/mA.
 - The maximum laser output power $P_{max} = \underline{\hspace{2cm}}$ mW at its maximum drive current.
 - k) From the I-P graph, find the trendline for the linear part from the threshold to the maximum values. The laser power $P = \eta (I - I_{th}) = \underline{\hspace{4cm}}$.
4. Follow the directions in section 3.3 – 3.4 of the PM user manual to set up the Nd:YAG laser depicted in Figure 1-18.
 5. Make the following measurements of the Nd:YAG laser output.
 - a) After properly aligning the laser set-up (per the PM user manual), the laser should produce radiation at 1064 nm. This radiation cannot be seen with the eye, so the plate holder with the RG 1000 filter is inserted into the path of the beam after the laser output coupler. The filter absorbs the pump laser radiation, and only the Nd:YAG laser radiation is transmitted.
 - b) Remove the PM photodiode from the rail assembly.
 - c) Set the power meter close to the Nd:YAG laser, so that the all light from the laser goes directly through the power meter's aperture and is incident on the detector's sensitive area. Do not move any part of this set-up once you have assembled it. If you move it, you may change the background radiation level entering the detector and introduce inconsistency into your measurements.

- d) Using readings from the power meter optimize the laser output power. This optimization can be done by adjusting the pump beam's angle of incidence on the Nd:YAG resonator and changing the position of the pump beam's focus in the resonator. Instructions for making these adjustments are given in the PM user manual.
- e) Find the laser threshold by reducing the pump power (lowering the drive current) until the Nd:YAG laser stops lasing.
- f) Once the laser has been adjusted to the maximum output power, use an optical power meter to measure the Nd:YAG laser output power. Then incrementally reduce the pump drive current from its maximum value to its threshold value. Record the current readings and power measurements in Data Table 2. Turn off the diode laser power supply.
- g) From the drive current, calculate the pump power using the equation in step 3k. Record this value in the middle column of the Data Table 2.

Data Table 2. Diode Laser Pump Power and Nd:YAG Laser Power Data Sheet

Diode Drive Current I (mA)	Calculated Pump Power P_{pump} (mW)	Measured Nd:YAG Laser Output Power $P_{Nd:YAG}$ (mW)

- h) From the recorded data in the Data Table 2, plot the **Nd:YAG laser power vs. pump power**. From the plot, find:
 - The laser threshold $P_{th} =$ _____ mW.
 - The maximum laser output power = _____ mW.
 - The laser slope efficiency $\eta =$ _____ %.
- From the graph, find the trendline for the linear part that represents the laser power $P_{Nd:YAG} = \eta (P_{pump} - P_{th}) =$ _____.

6. Use the directions in section 3.5 of the user manual to frequency double the output of the laser. Make the following measurements of the frequency doubled Nd:YAG laser output.

A nonlinear crystal (KTP) is used to double the frequency of the IR output from the Nd:YAG laser to a visible wavelength at 532 nm. To measure this visible radiation, follow the instructions in the PM user manual to replace the RG1000 filter with a BG39 filter, which blocks the pump and resonator light but transmits the green radiation.

- a) Remove the PM photodiode from the rail assembly.
- b) Position the optical power meter so that it detects the green light exiting the KTP crystal.
- c) Once the optical power meter detects the green light, fine tune the XY adjustment and the tilt-angle adjustment of the crystal holder to maximize the power-meter reading.
- d) Measure the power of the laser output at 532 nm as a function of diode laser current. Use the same drive current and Nd:YAG laser-output power values that you recorded in Data Table 2. Measure the green light power for these values and record your results in Data Table 3.

Data Table 3. Nd:YAG Laser Power and Green Laser Power

Diode Drive Current I (mA)	Nd:YAG Laser Output Power $P_{Nd:YAG}$ (mW)	Measured Green Light Power P_{Green} (mW)

- e) From the recorded data in Data Table 3, plot the *Green Light Power (P_{Green}) vs. Nd:YAG laser power ($P_{Nd:YAG}$)*.
7. Remove the frequency doubling module that you added in step 6 and use the instructions in section 3.6 of the PM user manual to provide the Nd:YAG laser with Q-switching capability.

8. Make the following measurements of the output of a Q-switched Nd:YAG laser:
 - a) Remove the PM photodiode from the rail assembly.
 - b) Position an optical power meter so that it measures the laser output of the Nd:YAG crystal. Turn on and zero the meter. Tilt the meter slightly with respect to the incident laser to prevent back reflections that could damage the laser's optical components.
 - c) Operate the laser with its maximum pump power and measure the average powers P_{avg} at different repetition rates. Record these values in Data Table 4. The repetition rates you can use will depend on the capability and type of Q-switch and controller provided in your PM kit. Pick up the lowest and the highest repetition rates that can be generated by the PM kit and add three more data points uniformly between them.

Data Table 4. Nd:YAG Output Power at Different Repetition Rates

Repetition Rate R (Hz)	P_{avg} (mW)	E_{pulse} (mJ)	τ (ns)	P_{peak} (W)

- d) Turn off the optical power meter and replace it with a fast photodiode. (If it is fast enough, use the PM photodiode and position it as depicted in Figure 1-17.) The signal from the fast detector is displayed using a fast oscilloscope. Measure the pulse width τ of the Q-switched pulses at different repetition rates and record the results in Data Table 4.
- e) Turn off the laser.
- f) Calculate the energy per pulse E_{pulse} using $E_{pulse} = P_{avg} / (\text{Repetition Rate})$.
- g) Calculate the peak power of the laser pulses P_{peak} at different repetition rates, $P_{peak} = E_{pulse} / \tau$.
- h) From the recorded data in Data Table 4:
 - Plot the *Average Power* (P_{avg}) as a function of *Repetition Rate* (R).
 - Plot the *Energy per Pulse* (E_{pulse}) as a function of *Repetition Rate* (R).
 - Plot the *Pulse Width* (τ) as a function of *Repetition Rate* (R).
 - Plot the *Peak Power* (P_{peak}) as a function of *Repetition Rate* (R).

WORKPLACE SCENARIO

Here is your opportunity to use the concepts you have learned in this module to solve an actual problem that could arise in a photonics company. Your instructor will provide directions for developing a solution.

Adjusting the Output of a Continuous Nd:YAG Laser

Scenario

Your organization has a Spectra Physics HIPPO Q-switched Nd:YAG Laser with a Model J80 Power Supply. It has previously been operated in continuous wave (CW) mode. You have been asked to explore the range of which the following critical parameters, or characteristics, are capable of being modified:

- Output Average Power
- Q-Switched Pulse Peak Power
- Pulse Duration
- Pulse Repetition Frequency
- Output Wavelength

Describe what you would do to change each of the critical parameters listed above. Determine the possible range that can be achieved for each output characteristic.

Describe the process and additional components needed to convert the output wavelength to 532nm. Determine what components are commercially available for this purpose.

Is this laser capable of being operated in a pulse-pumped mode? If so, what would be required to operate the laser in a pulse-pumped mode? How would this change each of the laser's critical parameters or characteristics?

Additional Information

You can find the information you need to solve this problem from at least four sources:

1. An explanation of the Q-switched laser operational parameters and their effect on output can be found in Module 2-1, *Laser Q-Switching, Mode Locking, and Frequency Doubling*.
2. An operating manual for this laser might be found on the Internet, or your instructor may have one available.
3. Online resources.
4. Information on second harmonic generation (SHG) components can be found online, or your instructor may have them available.

Problem and Tasking

1. Examine the configuration and parameters of the Nd:YAG laser, as well as the typical range of available output critical parameters and characteristics.

2. Create a table that documents the range of available values for the laser's critical parameters and operational characteristics. Would you need any different component or components to make these changes? If so, what additional equipment would you need?
3. Prepare a diagram of the laser, showing the layout of the required components.
4. If this laser is capable of pulse-pumped operation, what would be required to operate the laser in a pulse-pumped mode?
5. Calculate the output-beam parameters that would result from SHG to produce the 532 nm wavelength.

Laser Specs:

- Spectra-Physics (CW and Pulsed)
- HIPPO (High Peak Power Oscillator) Laser Head with a Model J80 Power Supply
- It is a fiber-coupled, diode pumped, Q-switched laser system with outputs of 17 W at 1064 nm.
- It can also operate with a SHG doubler to produce 11 W at 532 nm.
- Or 5 W at 355 nm with an automated frequency tripler.
- Or 2 W at 266 nm with a frequency quadrupler.
- Pulse rate is from 15 to 300 KHz.

NOTE: If you cannot locate information about this laser, select a more current solid state Q-switched laser for this scenario. Document the change, along with the specifications of the new laser that you have selected.

PROBLEM EXERCISES AND QUESTIONS

1. Explain the basic principles of Q-switching, including the following concepts and their relationships to the Q-switching process:
 - a) Amplifier gain
 - b) Loop gain
 - c) Cavity quality
2. Draw and label diagrams showing the time histories of input light, stored energy, amplifier gain, loop gain, and output for the cases of feedback mirrors removed, normal mode operation, and Q-switched operation.
3. Compare the pulse duration and peak power of normal pulse and Q-switched lasers.
4. List and explain the four most important characteristics of Q-switches.
5. List and explain the operation of the four major types of Q-switch.
6. Explain the factors that reduce the efficiency of a typical Q-switched laser as compared to a normal pulse laser.
7. Name one type of laser that cannot be Q-switched, and explain why this is so.
8. A laser has mirrors with reflectivities $R_1 = 0.998$ and $R_2 = 0.50$, a round-trip loss of 6%, and an amplifier gain of 10. Determine the dynamic loss (double pass) necessary for a Q-switch to prevent lasing in this system.
9. Describe what is meant by *mode locking*.
10. Describe two methods of mode locking.
11. Give two examples of mode locked lasers that have been widely used.
12. If the bandwidth of the emission spectrum of a material is 50 THz, what is the approximate minimum pulse duration that could be obtained from it in a mode locked pulse?
13. Give at least two examples of applications for mode locked lasers.
14. Describe a system's linear and nonlinear behavior using appropriate equations.
15. Explain second harmonic generation of light with the aid of induced charge polarization.
16. List and rate the importance of at least three of the more common nonlinear optical materials.

REFERENCES

- Gurzadyan, Gagik G., Valentin G. Dmitriev, and D. N. Nikogosyan. 2010 *Handbook of Nonlinear Optical Crystals*. New York: Springer-Verlag.
- Hitz, C. Breck, James Ewing, and Jeff Hecht. 2012. *Introduction to Laser Technology*. New York: Wiley-IEEE Press.
- Koechner, Walter. 2009 *Solid State Laser Engineering*. New York: Springer-Verlag.
- O'Shea, Donald C., Russell W. Callen, and William T. Rhodes. 1977. *Introduction to Lasers and Their Applications*. Reading, MA: Addison-Wesley Publishing Co. Chapter 5.
- Paschotta, R. and U. Keller. 2007. Passively Mode-Locked Solid State Laser. In *Solid State Lasers and Applications*, ed. Alphan Sennaroglu. Boca Raton, FL: CRC Press.
- Ready, John F. 1997. *Industrial Applications of Lasers*. San Diego, CA: Academic Press. Chapters 2 and 5.
- Ruthiere, Claude. 2005. *Femtosecond Laser Pulses*. New York: Springer.
- Silfvast, William T. 1995. Lasers. Chapter 11 in *Handbook of Optics*, ed. Michael Bass. New York: McGraw-Hill.

INDEX OF TERMS

A

Absorption, 4
Active effects, 27

D

Damage, 29
Dipole moment, 24
Dipole, 24

F

Fixed phase relationship, 18
Fluorescence, 7
Frequency doubling, 2, 22, 26

G

Gain, amplifier, 5
Gain, loop, 7

L

Linear behavior of a system, 23
Longitudinal modes, 18

M

Mode lockers, 2
Mode locking, 2, 17
Mode locking, active and passive, 20

N

Nonlinear behavior of a system, 23
Nonlinear optics, 2, 27

O

Optical cavity, 1

P

Passive effects, 27
Polarization of a charge, 24

Q

Q-switches, 2
Q-switches, applications of, 16
Q-switches, types of, 14-16
Q-switching characteristics, 13
Q-switching, 2, 8
Q-switching, effect on parameters, 11, 12
Quality, 8

S

Second harmonic generation (SHG), 26

U

Ultrashort pulses, 17, 20-21

Laser Output Characteristics

Module 2-2

of

Course 2, *Laser Systems and Applications*
2nd Edition

OPTICS AND PHOTONICS SERIES

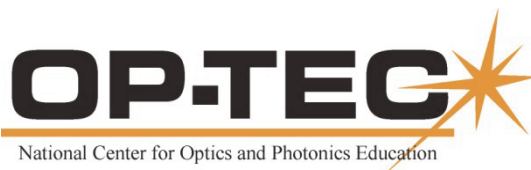

© 2016 University of Central Florida

This material was developed by the National Center for Optics and Photonics Education, OP-TEC, and is based upon work supported by the National Science Foundation under Grant No. 1144377 and completed under Grant No. 1303732. Any opinions, findings, and conclusions or recommendations expressed in this material are those of the author(s) and do not necessarily reflect the views of the National Science Foundation.

For more information about the text or OP-TEC, contact:

Dan Hull
PI, Executive Director, OP-TEC
316 Kelly Drive
Waco, TX 76710
(254) 751-9000
hull@op-tec.org

Published and distributed by

OP-TEC
316 Kelly Drive
Waco, TX 76710
254-751-9000
<http://www.op-tec.org/>

ISBN 978-0-9983480-1-8

CONTENTS OF MODULE 2-2

Introduction	1
Prerequisites	1
Objectives	1
Basic Concepts	2
Laser Beam Characteristics	2
Coherence	3
Beam Divergence	3
Laser Light Intensity	5
Laser Beam Diameter	6
Focusing a Laser Beam	7
Pulse Properties of a Laser	8
Optical Detectors	9
Detector Parameters	10
Detector Categories	10
Measurements	20
CW Power Measurements	20
Pulse Energy Measurements	22
Pulse Duration Measurements	24
Measuring Laser Beam Divergence	26
Beam Quality Factor, M2	27
Spectral Measurements	28
Beam Profilers	30
Summary	31
Laboratory	32
Workplace Scenario	38
Problem Exercises and Questions	39
References	40
Index of Terms	41

Module 2-2

Laser Output Characteristics

INTRODUCTION

Lasers are used for a wide variety of applications, and typically each application has different specifications. To ensure that the laser does in fact meet the required specifications, it is necessary to measure the laser output characteristics. The most common laser measurements that provide this characterization are beam divergence, power, pulse duration, and energy.

This module presents techniques for making these common laser measurements and also provides technical descriptions of detectors used to collect data for these measurements. We do not describe detectors made by specific manufacturers; instead, we focus our explanations on the basic operating principles of the generic detectors most commonly used in industry: photoconductive detectors, photodiodes, vacuum photodiodes, photomultipliers, pyroelectric detectors, bolometers, and thermopiles. By gaining an understanding of these basic principles, you will have the foundation needed to operate, maintain, calibrate, and monitor detectors made by a wide variety of manufacturers.

To give you hands-on experience in using these detectors, this module includes a laboratory in which you will use a variety of different instruments to measure the output of a laser.

PREREQUISITES

OP-TEC's *Fundamentals of Light and Lasers Course*

OP-TEC's *Laser Systems and Applications Course, Module 1: Laser Q-Switching, Mode Locking, and Frequency Doubling*

Understanding of high school level trigonometry and algebra concepts, including exponentials and logarithms

OBJECTIVES

After completion of this module, the student should be able to:

- Describe the function and applications of the following types of detectors, using diagrams as appropriate.
 - Photoconductive detectors

- Photodiodes
- Vacuum photodiodes
- Photomultipliers
- Pyroelectric detectors and the relative advantages and disadvantages of two different types
- Bolometers
- Thermopiles
- Discuss the differences between photon detectors and thermal detectors.
- Discuss the responsivity and detectivity of optical detectors and give units for each.
- Describe transverse electromagnetic modes, with special emphasis on the Gaussian mode.
- Calculate the approximate spot size (diameter) of focused light.
- Draw a flow diagram for all energy incident on a target material and identify the factors that contribute to energy loss (energy that does not contribute to temperature rise).
- Draw the experimental setup for measuring the beam divergence of a CW laser beam, and describe how to generate the necessary data and determine the beam divergence angle.
- Discuss the beam quality factor M^2 .
- Describe the applications of beam profilers.
- Explain the use of a spectrometer in characterizing laser output.
- Use the equipment and techniques described in this module to determine the characteristics of lasers in the laboratory.

BASIC CONCEPTS

Laser Beam Characteristics

Lasers are characterized by measuring various parameters related to their light output. These include temporal characteristics and spatial characteristics. The temporal characteristics may be divided into two broad categories: continuous wave (CW) and pulsed. CW lasers are those whose power output undergoes little or no fluctuation with time; instead, these lasers exhibit a steady flow of energy. A common example is the helium-neon (HeNe) laser. Another group of lasers has output that changes rapidly with time. The output power typically rises rapidly to a peak value and then declines to zero or near zero. Pulsed operation may be divided into other operating modes:

- Normal pulsed mode
- Q-switched mode

- Mode-locked mode
- Ultrashort pulsed mode

Other modes of pulsed operation include single pulse, repetitive normal pulse, continuously pumped–repetitively Q-switched, repetitively pulsed mode locked, and other modes.

Each of these different modes of operation produces a different laser output. To characterize these many outputs, we need to define a set of parameters that will allow us to compare the output of one mode of operation with another. This set must provide a description of both the spatial and time-dependent characteristics of the light emitted by a laser. We have such a set, and it was defined in Module 1-6 of the *Fundamentals of Light and Lasers Course*. The text below summarizes these parameters for quick reference. If you are not familiar with these parameters, we encourage you to go back to Module 1-6 and carefully study them before continuing your study of Module 2-2.

Coherence

Temporal coherence: Coherence deals with the phase relationship between two waves whose wavelengths are close to each other. If two waves are of exactly the same wavelength and continue to be either in phase or out of phase with each other for an infinite distance, then perfect coherence exists between them. But a real laser is not a perfectly coherent source; instead, coherence exists only during a limited time.

The distance along which two waves maintain the same phase relationship as they travel forward is called *coherence length*. The coherence length and the coherence time are related by the simple equation

$$\ell_c = c\tau_c \quad (2-1)$$

where ℓ_c is the coherence length; τ_c is the coherence time, which is the duration of time over which the phase of the wave remains fixed; and c is the speed of light in vacuum.

Spatial coherence: This type of coherence concerns the phase relationship of different parts of the laser beam *across the width* of the laser beam. The larger the width of the emitting light source, the smaller will be the *spatial coherence width* of the emitted light.

Beam Divergence

An ideal laser would have no beam divergence (or spread) as it moves forward. Such an ideal beam is monochromatic and so has an infinite coherence length. However, a real laser does have a beam divergence. In fact, beam divergence is an indirect measure of the coherence of the beam. Smaller beam divergences are indications of better coherence and longer coherence lengths. An exaggerated diverging laser beam is shown in Figure 2-1.

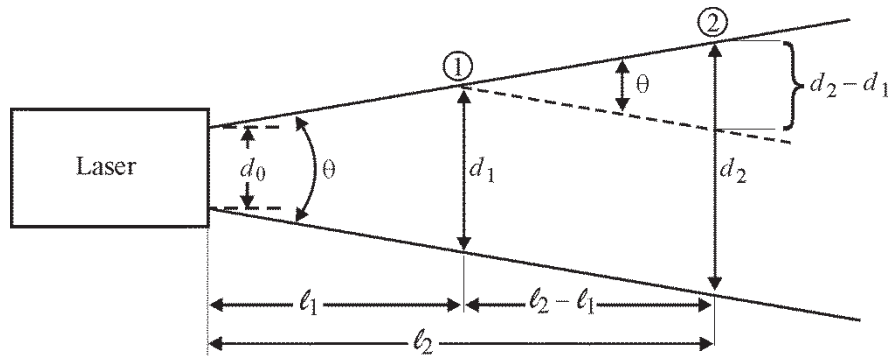

Figure 2-1 Beam divergence of a laser beam

The diameter of the beam at the output mirror of the laser is d_0 . At a distance ℓ along the beam, the beam diameter is d . This beam diameter is given by Equation 2-2.

$$d = (\ell \times \theta) + d_0 \quad (2-2)$$

where d is the beam diameter at distance ℓ from the laser,
 d_0 is the beam diameter as it exits the laser,
 ℓ is a distance along the beam at which the beam diameter is d , and
 θ is the beam divergence, measured in radians.

A more useful equation can be written in terms of two diameters d_1 and d_2 at distances ℓ_1 and ℓ_2 , as shown in Figure 2-1. The beam divergence can now be given by Equation 2-3 as:

$$\theta = \frac{d_2 - d_1}{\ell_2 - \ell_1} \quad (2-3)$$

The beam divergence can be determined by measuring the beam diameters at two different places along the beam.

Near- and far-field divergence: In the design of cavity mirrors, it is sometimes desirable to design the output coupler as a converging lens, with the inner surface of the lens serving as the output coupler mirror. See Figure 2-2. In such a design, the emitted beam first converges and then diverges, as shown in the figure.

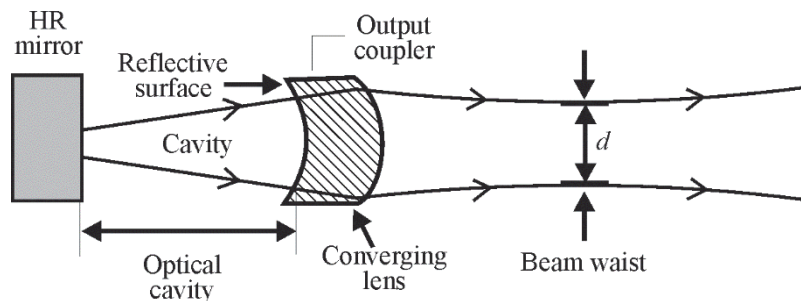

Figure 2-2 Collimation of a laser beam by a mirror/lens output coupler

If the beam diameter is measured near the output coupler, the measurement of beam divergence will be in error because the beam is not yet uniformly diverging. The position where the beam converges to a minimum diameter before diverging is called the *beam waist*. In order to

correctly measure the beam divergence, the beam diameters have to be measured at a sufficiently long distance from the beam waist. Two regions for beam divergence are specified. The *near-field divergence* region extends a distance ℓ_{NF} from the beam waist, where ℓ_{NF} is given by Equation 2-4.

$$\ell_{\text{NF}} \leq \frac{d^2}{\lambda} \quad (2-4)$$

Here λ is the wavelength of the beam, d is the diameter of the beam waist, and ℓ_{NF} is the limiting distance of the near-field region from the beam waist. By contrast, the *far-field divergence* is given by Equation 2-5.

$$\ell_{\text{FF}} \geq 100 \frac{d^2}{\lambda} \quad (2-5)$$

where ℓ_{FF} is any distance from the laser greater than $100 \frac{d^2}{\lambda}$.

To make accurate beam divergence measurements, one should perform measurements of beam diameters at distances ℓ greater than ℓ_{FF} .

Diffraction-limited beam divergence: When a laser beam passes through an aperture of diameter d , a certain amount of light spreads outside the aperture edges. Since diffraction is a natural occurrence, one cannot obtain a beam divergence or spread of **lesser** value than that dictated by diffraction. The minimum value permitted, in the presence of diffraction, is referred to as the *diffraction-limited beam divergence*. This minimum beam divergence, according to laser theory, is given by Equation 2-6. It is always less than that given by Equation 2-3.

$$\theta_{\text{min}} = \frac{1.27\lambda}{d} \quad (2-6)$$

The constant 1.27 is a value derived from cavity parameters, d is the diameter of the beam waist or effective aperture, and λ is the wavelength of the laser beam.

Laser Light Intensity

Intensity I of light (often called irradiance) is given by Equation 2-7:

$$\text{Intensity } (I) = \frac{\text{Power } (P)}{\text{Area } (A)}, \text{ usually in units of } \frac{\text{W}}{\text{m}^2} \quad (2-7)$$

The power of a laser beam is the rate at which the beam delivers optical energy. It is the ratio of energy to time.

$$\text{Power } (P) = \frac{\text{Energy}}{\text{Time}}, \text{ usually in units of J/s or W} \quad (2-8)$$

Since intensity (irradiance) $I = \frac{P}{A}$ and the area, if circular, is $A = \frac{\pi d^2}{4}$, we have another form of Equation 2-7.

$$I = \frac{4P}{\pi d^2} \quad (2-9)$$

Laser Beam Diameter

The profile of a laser beam can be obtained by measuring the intensity across the beam. Figure 2-3 shows the cross-sectional intensity profile of a fundamental mode, or TEM_{00} , laser beam. This profile is the lowest order mode, and approximates a Gaussian function, which is used extensively in probability theory. Because of this similarity, the beam depicted in Figure 2-3 is called a Gaussian beam.

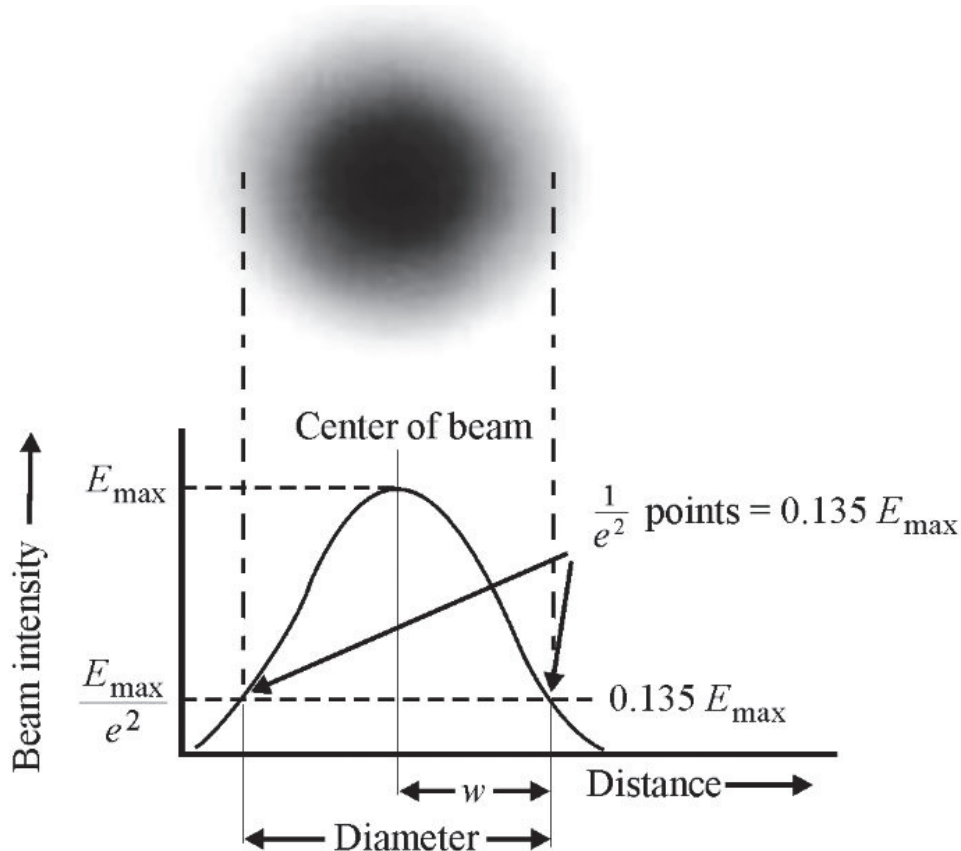

Figure 2-3 Width of a TEM_{00} laser beam at the $1/e^2$ points

The beam intensity falls off on either side of the beam center. The intensity gradually decreases to zero. Hence, it is difficult to define exactly what the beam width is. To compare beam diameters of different laser beams, we define the beam diameter as the distance between the $(I_{\max} \times 1/e^2)$ points of beam intensity on either side of the beam center. The symbol w denotes half this distance.

The relationship between the diameter of the beam and the diameter of an aperture in the path of the beam has a significant effect on how much power is transmitted through the aperture.

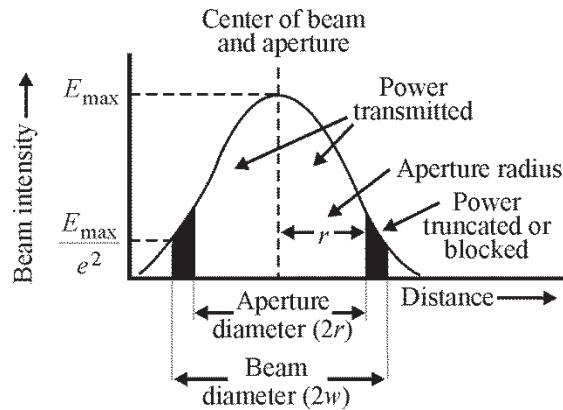

Figure 2-4 Transmission of a TEM_{00} laser beam through an aperture smaller than the beam diameter

The beam power transmitted through a circular aperture of radius $r = a$, compared to the total power incident on the aperture, is given by Equation 2-10.

$$\Phi_{\text{frac}} = 1 - e^{-2\left(\frac{a}{w}\right)^2} \quad (2-10)$$

Where a is the radius of the circular aperture, w is the beam radius at the $1/e^2$ points, and Φ_{frac} is the fraction of incident beam power that is transmitted. Figure 2-5 shows, as the ratio a/w becomes smaller, the transmission is reduced considerably.

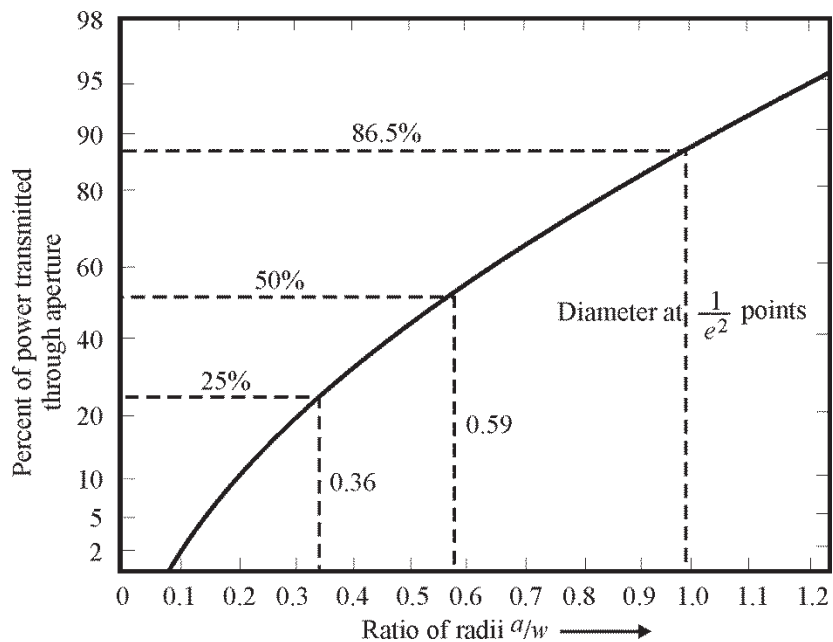

Figure 2-5 Graph showing percent of beam power transmitted versus the ratio of aperture radius to beam radius for a TEM_{00} beam

For very small values of a/w , the intensity drops almost exponentially. At a ratio of $a/w = 1$, where the $1/e^2$ beam diameter equals the aperture diameter, 86.5% of the beam power gets through.

Focusing a Laser Beam

Laser beams can be focused to a very small *spot size*. The ability to focus the beam to a very small size depends on both the quality of the beam and the quality of the lens used to focus the beam. The diameter of the *spot* of a focused beam (Figure 2-6) is given by Equation 2-11.

$$d = f\theta \quad (2-11)$$

where f is the focal length of the convex lens, d is the diameter of the focused spot, and θ is the beam divergence of the incident beam. The smaller the beam divergence and the smaller the focal length of the lens, the smaller will be the spot size.

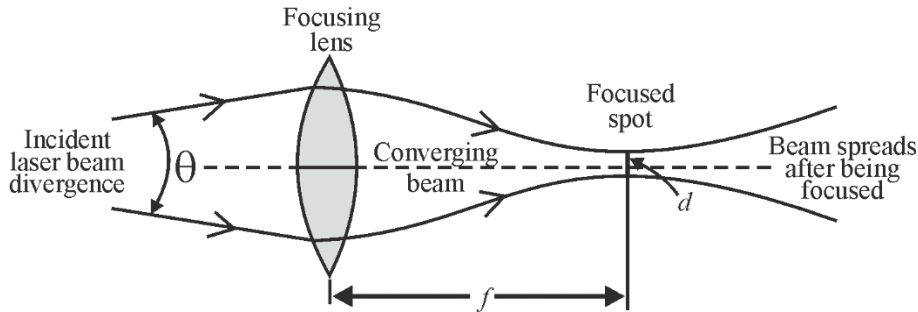

Figure 2-6 Focusing a laser beam

Pulse Properties of a Laser

A pulse of laser power graphed against time has a bell shape. For simplicity, this bell is assumed to be a triangle. See Figure 2-7.

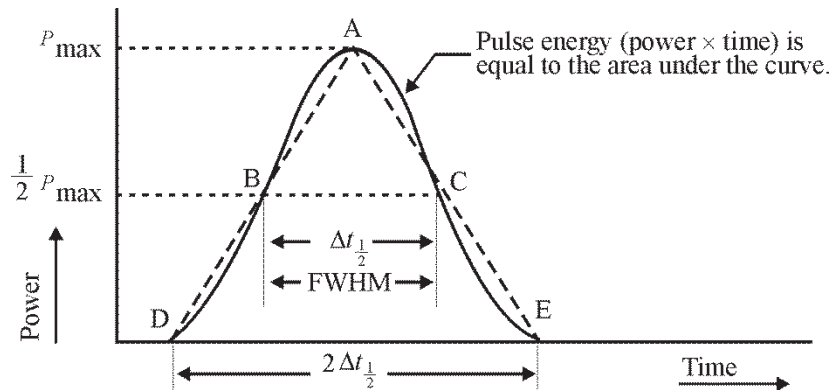

Figure 2-7 Energy in a laser pulse

The peak of the triangle at A is P_{\max} (the peak power of the pulse). The *pulsewidth* $\Delta t_{1/2}$, distance BC, is the width of the pulse at half the height of the pulse, and is given in seconds. The pulsewidth is referred to as the full width at half maximum (FWHM). The total time duration of the pulse is represented by the width at the bottom of the pulse, distance DE. It is equal to $2 \times \Delta t_{1/2}$. The area of a triangle is $\frac{1}{2} \times \text{base} \times \text{height}$. The energy of the pulse, which is given by the product of power \times time, can be approximated by substituting the shape of the triangle for the true shape of the pulse. Thus,

Area of a triangle = $\frac{1}{2} \times \text{base} \times \text{height}$

Area of pulse \approx area of triangle DAE = energy of pulse

\therefore Energy of pulse (E) $\approx \frac{1}{2} \times \text{base} \times \text{height} = \frac{1}{2} \times (2\Delta t_{1/2}) \times P_{\max} = (\Delta t_{1/2}) \times P_{\max}$

So,

$$E = \Delta t_{1/2} \times P_{\max} \quad (2-12)$$

When the laser output consists of a series of pulses, it is called a *pulse train*. The characteristics of such a pulse train are as follows. The time from the beginning of a pulse to the beginning of the next pulse is called the pulse repetition time (*PRT*). The energy of a pulse in the pulse train can be found using Equation 2-12, but is also the same as the rectangle whose width is *PRT* and whose height is P_{avg} (the average power of the pulse). See Figure 2-8.

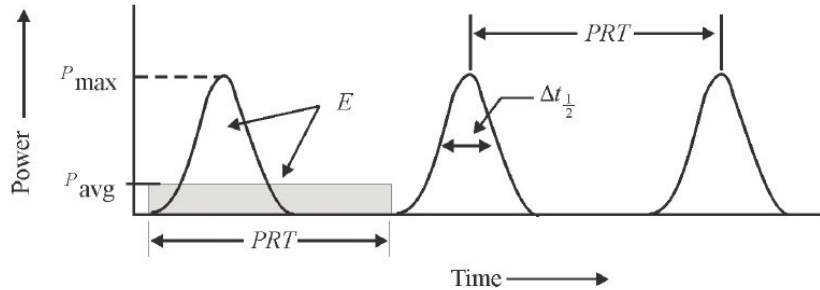

Figure 2-8 Average power and pulse repetition time of a pulse in a pulse train

By combining Equation 2-12 with the area of the rectangle in Figure 2-8, we can generate an expression for the pulse energy in terms of *PRT* and P_{avg} :

$$E = \Delta t_{1/2} \times P_{max} = P_{avg} \times PRT \quad (2-13)$$

The reciprocal of the pulse repetition time (*PRT*) is called the pulse repetition rate (*PRR*) and is given by Equation 2-14.

$$PRR = \frac{1}{PRT} \quad (2-14)$$

Additionally, the pulse energy can be expressed in terms of the pulse repetition rate *PRR*, as given by Equation 2-15.

$$E = \frac{P_{avg}}{PRR} \quad (2-15)$$

To use the parameters defined in Equations 2-1 through 2-15 to characterize the output of a laser, we need devices that will detect this output and quantify these parameters. The remainder of this module presents a variety of devices, each of which has a unique way of detecting laser light and providing the information we need to quantify the parameters that characterize this light.

Optical Detectors

The basic element in any optical power or energy measurement is the detector. The detector converts the incoming optical signal into an electrical signal, which is then amplified and recorded. Whether one is using a power meter, an energy meter, or a calorimeter, it is the detector that determines the basic operating parameters of the measuring device. To understand

these measurement devices, you first need a basic understanding of the various detectors you might use. Because of this, detectors will be discussed first in this module, followed by a discussion of measurement devices and their application to the measurement of specific laser parameters.

Detector Parameters

A detector's major parameters of interest are (1) its responsivity to input optical power; that is, how much electrical output signal is available for a given optical input, (2) its sensitivity to the wavelength of the incoming radiation; that is, the optical wavelengths to which this detector will give a measurable response, (3) its temporal response; that is, how well the output signal from the detector follows changes in the incoming optical signal with time, and (4) the noise inherent in the detector; that is, how much internal noise voltage at the output of the detector must be surmounted before the signal can be positively identified. Parameter 3, temporal response, is extremely important for proper measurement of pulsed laser output (it is not nearly as important for CW measurements). Parameter 4, detector noise, is extremely important in measurement of very low powers but not so important at high powers. The noise present in a detector is usually indicated by a quantity called the detectivity (D^*), which is a measure of the detector's signal-to-noise ratio.

Detector Performance

The performance of light detectors is defined by commonly used quantities. One such quantity is *responsivity*. The responsivity is the amount of output that comes from the detector per unit of input. The output may be either a voltage (in which case, the units of the responsivity are volts per watt (V/W)) or a current (in which case, the units are amperes per watt (A/W)). For pulsed lasers, the responsivity may have units of volts per joule (V/J).

Responsivity is a function of wavelength. It tells the user how large an output signal will be when a signal with a specified input is incident on it. Manufacturers generally specify a detector's responsivity, and this specification does not take into account noise in the detection system. However, if the laser signal is large, noise is typically not an important factor.

The performance of a detector when noise is important (either noise inherent in the detector itself or noise from fluctuations in the incoming signal) is specified by a quantity called *detectivity*. Detectivity is a detector's ability to measure a small signal in the presence of noise. Detectivity is represented by the symbol D^* and is a function of the wavelength λ , the frequency f at which the measurement is made, and the bandwidth Δf of the measurement. Detectivity is thus represented by the nomenclature $D^*(\lambda, f, \Delta f)$. The bandwidth chosen is usually 1 Hz. The units of detectivity are centimeter-square-root-Hz/watt ($\text{cm}\cdot\text{Hz}^{1/2}/\text{W}$). A high value of D^* indicates that a detector has a good capability of distinguishing a signal in the presence of noise.

Thus, when you use a detector to measure the output of a high power laser at close range, responsivity is likely to be the important factor. When you monitor a weak signal at long range (as in optical communications), detectivity may be more important.

Detector Categories

Detectors used in optical measurements can generally be characterized as *photon detectors* or *thermal detectors*.

Photon Detectors	Thermal Detectors
respond to the number of individual photons incident onto the active surface of the detector	respond to total optical power
rely on release of electrons by absorption of photon in the detector material and subsequent changes produced by these electrons in external circuitry	absorb input radiation, producing a temperature rise that changes some other parameter, such as resistance, contact potential, or polarization
<i>Types: photoconductors, photodiodes, vacuum photodiodes, photomultipliers (PMT)</i>	<i>Types: pyroelectric detectors, thermocouples, bolometers, thermopiles, and calorimeters</i>

The photon detector responds to the number of individual photons incident onto the active surface of the detector, whereas the thermal detector responds to total optical power. Photon detectors rely on release of electrons by absorption of photons in the detector material and subsequent changes produced by these electrons in external circuitry. Thermal detectors absorb this input radiation, producing a temperature rise that changes some other parameter, such as resistance, contact potential, or polarization. The world of thermal detectors includes thermocouples, bolometers, and pyroelectric detectors.

Photon Detectors

Common photon detectors are photoemissive detectors, which operate on the basis of the photoelectric effect, and solid-state semiconductor detectors, which operate on the generation of charge carriers in the solid by the action of incident photons. In both kinds of detectors, the incident photons interact with the electrons in the detector material and separate these electrons from their parent atoms. If a potential difference exists in the region of the detector where these separated electrons exist, these electrons will move under this influence and establish an electrical current. Electrical circuitry connected to the detector will respond to this current and provide a means of measuring its magnitude.

Photoconductors

A photoconductor simply consists of a piece of semiconducting material in which charge carriers are generated by the interaction of the incoming photons on the electrons in the detector material. This causes an increase in charge carriers in the detector, which results in a decrease in detector resistance. This decrease is ultimately seen as an increase of current in the external circuit. Although photoconductors can be made to be responsive to radiation from the ultraviolet to the far infrared, they are primarily used for wavelengths above one micrometer. Such devices have relatively high responsivities (1 to 5 A/W) and respond to signal changes in as quickly as one microsecond. Although they are theoretically not quite as noise-free as the photodiode (which is discussed later), they can be designed to have an inherent noise level only two or three times that of the photodiode. Photoconductor response drops off on the long-wavelength end because a minimum photon energy is necessary to generate charge carriers. In the photoelectric effect, this minimum energy is referred to as the *work function*. Responsivity diminishes on the short-wavelength end since fewer high-energy photons are available per watt of optical power. This is because photons at higher frequencies carry more energy ($E = hf$), thus requiring fewer photons to transmit the total amount of energy in the light beam. Operation of a photoconductor

usually requires a cryogenic operating temperature. These low temperatures are needed to ensure that Johnson noise, induced by thermal fluctuations in the detector, does not hide the detector's response to light that is incident on it.

Figure 2-9 shows the detectivity as a function of wavelength for a number of different infrared photoconductive detectors. These detectors are commonly used at relatively long infrared wavelengths. The temperatures of operation are indicated. The variation of detectivity as a function of wavelength for each detector shows an increase of detectivity with wavelength up to a maximum, above which the detectivity drops rapidly. The maximum value of detectivity decreases as one moves farther into the infrared.

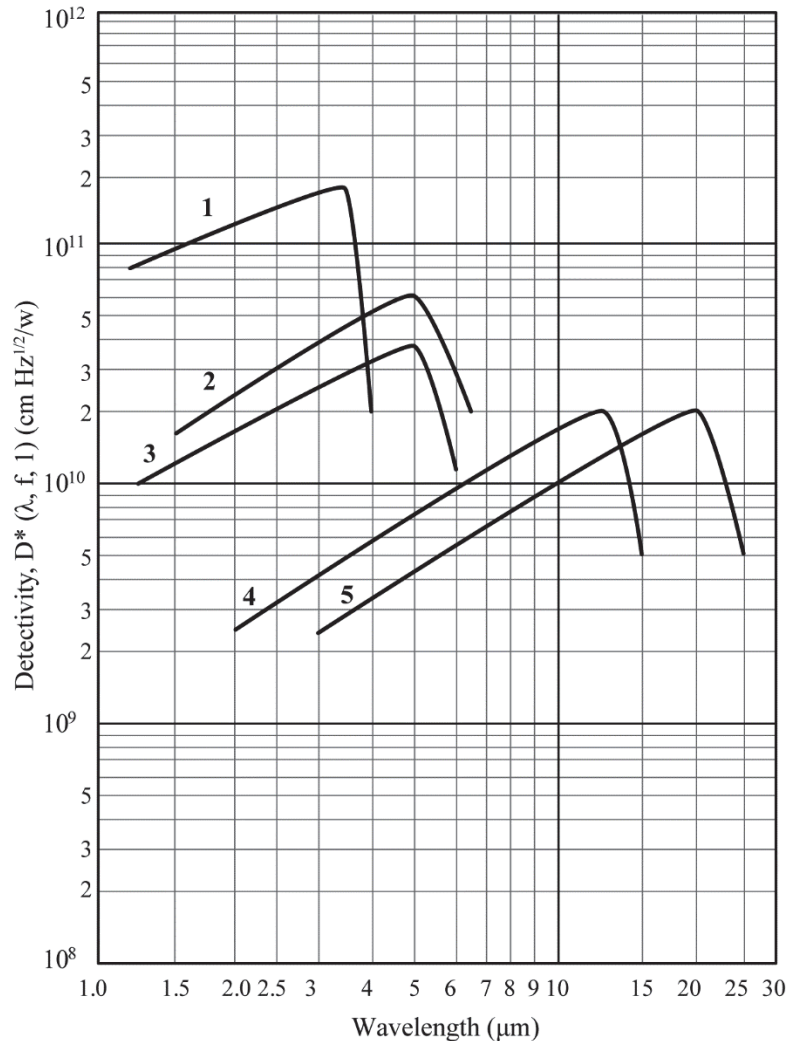

Figure 2-9 Detectivity of photoconductive detectors as a function of wavelength
 1. PbS, 77 K. 2. InSb, 77 K. 3. PbSe, 77 K. 4. Hg_{0.8}Cd_{0.2}Te, 77 K. 5. Ge:Cu, 4 K.

In the near infrared, 1–2 μm, lead sulfide (PbS) detectors are common. In the mid infrared, near 5 μm, indium antimonide (InSb) detectors are often used. Near 10 μm, at the carbon dioxide laser wavelength, mercury cadmium telluride (Hg_{0.8}Cd_{0.2}Te) detectors are used. All these detectors are usually cooled with liquid nitrogen to 77 K. Farther in the infrared, the detectors must be cooled with liquid helium to 4 K. Copper-doped germanium (Ge:Cu) provides response to wavelengths greater than 20 μm.

Photoconductors can have a fast time response and are useful for measuring the output of both CW and pulsed lasers.

Photodiodes

Photodiodes are semiconductor detectors in which the incident photon produces charge carriers in the junction region between a p-type semiconductor and an n-type semiconductor. This junction region, which is only a few micrometers in width, has a built-in potential on the order of a volt across it, thus leading to very large fields on the order of 10,000 V/cm. Carriers produced in this junction region are thus quickly swept out into the external circuitry, where they produce a measurable meter response or oscilloscope trace. A junction device of this nature has a maximum gain of one, resulting in a responsivity that is normally lower than that of the photoconductor. Because detection occurs as a result of carrier production in the high-field junction region, the temporal response of a photodiode is considerably faster than that of a photoconductor—typically on the order of nanoseconds. Photodiodes are available that are responsive to wavelengths from the ultraviolet through the near infrared. Internal noise in the photodiode is quite low, providing for a high signal-to-noise ratio. There are several types of photodiode detectors available, such as the p–n junction, the PIN photodiode, and the avalanche photodiode.

The most common photodiode detector is the PIN photodiode. In this device, there is a region of intrinsic semiconductor material between the p and n regions. This is shown schematically in Figure 2-10. This intrinsic region serves to increase the width of the junction, which in turn provides for more efficient conversion of photons to charge carriers.

These PIN devices can be operated in either a photoconductive or a photovoltaic mode. (Do not confuse the photoconductive mode of a photodiode with the photoconductor discussed above. They are totally different and not related to each other.) Photovoltaic operation is obtained when there is no bias voltage applied to the diode. The output voltage produced across the load resistor increases as the signal level increases. In this mode, the device produces an output voltage when light is incident on it, even without any input voltage. Such devices are often referred to as photovoltaic detectors.

Photoconductive operation occurs when the diode is back-biased so that it becomes a current source. Biasing of the detector results in a slight increase in noise and a higher dark current; however, the frequency response is extended, a feature that is extremely useful when faster laser pulses are being examined. PIN photodiodes can have frequency response up to 10^{10} Hz and thus can measure the pulse shape of nanosecond duration pulses.

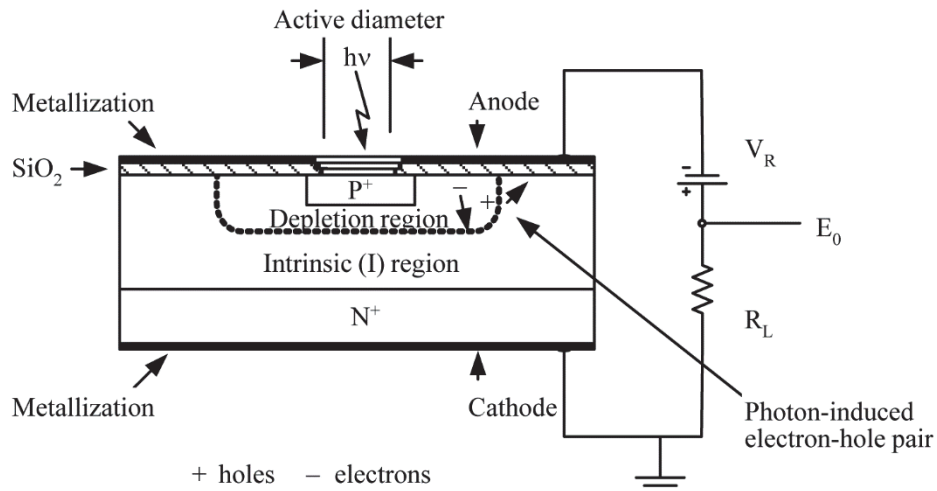

Figure 2-10 Cross section of PIN diode

Silicon PIN photodiode detectors are probably the most widely used laser detectors in the visible and near infrared regions of the spectrum. Figure 2-11 shows the response of a typical PIN silicon photodiode along with the wavelengths of some important laser sources. Such photodiodes operate at room temperature.

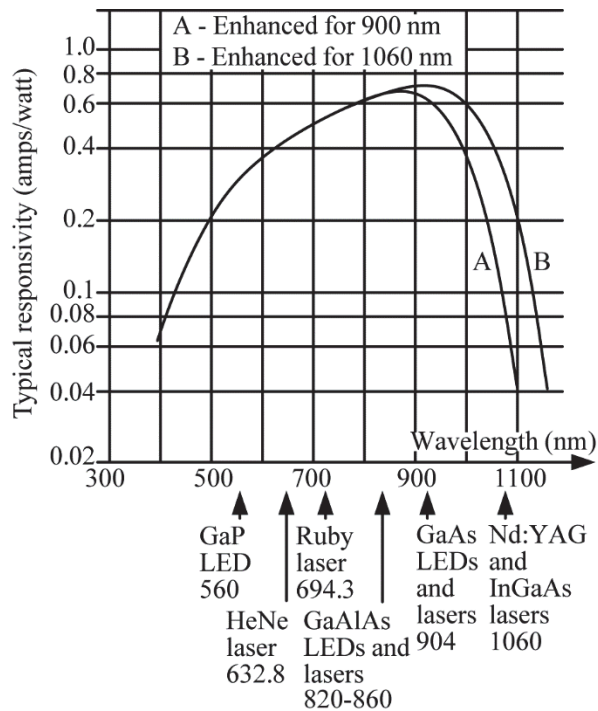

Figure 2-11 Spectral responsivity of PIN photodiodes

Vacuum Photodiodes

Vacuum photodiodes are simple photoemissive devices that are used to measure laser output from the ultraviolet to the near infrared (1.1 micrometers). A typical vacuum photodiode is shown in Figure 2-12. In this device, an incoming photon strikes the photocathode, causing a photoelectron to be emitted into the vacuum. This electron then travels to the anode, where it is

collected. The resulting current appears as a signal in the external circuit. The advantage of the vacuum photodiode lies in its very high frequency response (up to 2 GHz) and its ability to handle high incident powers.

As semiconductor photodiodes improve, they are increasingly replacing the vacuum photodiode in most applications. The reason for this is that semiconductor photodiodes have fast response times and are useful for both CW and pulsed lasers.

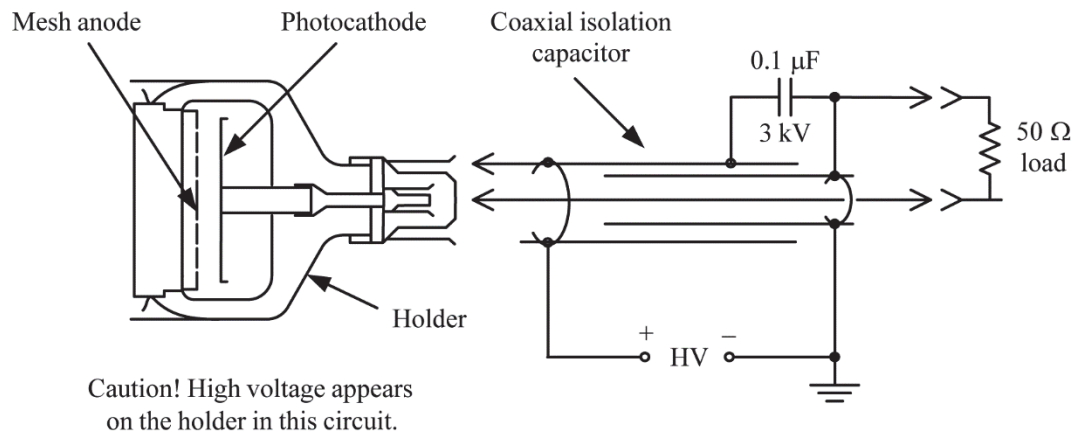

Figure 2-12 *Basic vacuum photodiode*

Photomultipliers

Photomultipliers, such as the one shown in Figure 2-13, are similar to vacuum photodiodes in that the incident photon causes the emission of an electron from the photocathode into the vacuum. In this case, however, the electron emission is subsequently amplified before collection at the anode. The amplifier consists of a series of plates, called dynodes, which have specifically prepared surfaces. As can be seen from Figure 2-14, a negative potential of approximately 1000 V (denoted HV) is applied to the photocathode and across a voltage divider. This produces equal voltage steps across the dynodes. A photon striking the photocathode causes an electron to be emitted. The electron is accelerated by the potential applied to the first dynode, where its kinetic energy is sufficient to free several more electrons. These accelerate to the second dynode, where the process is repeated, and so on for the entire dynode chain. The electrons leaving the final dynode are then collected by the anode. Since as many as 10^6 electrons can arrive at the anode as a result of a single incident photon, high gain (and thus high responsivity) characterizes a photomultiplier. As a result, photomultipliers are capable of measuring extremely low light levels, but they do require a high voltage supply and are easily damaged by exposure to irradiance levels above their design range.

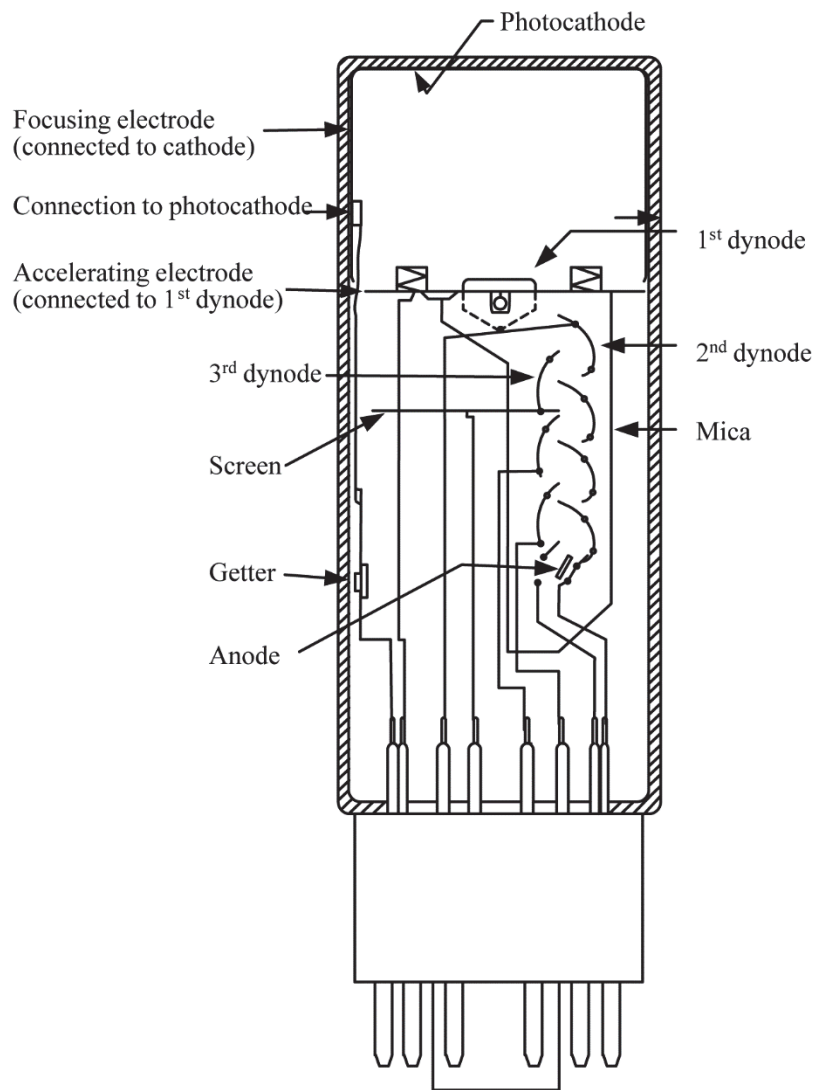

Figure 2-13 *Photomultiplier structure*

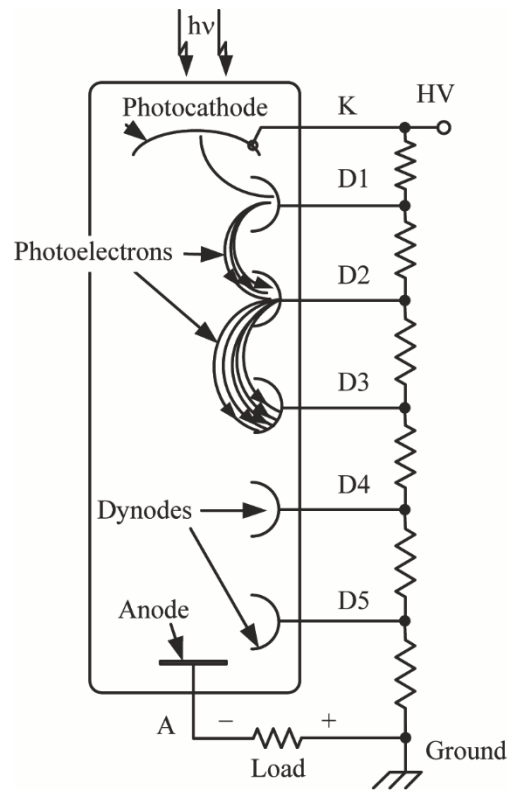

Figure 2-14 *Photomultiplier tube in principle*

Photomultipliers are sensitive to the same range of wavelengths that photodiodes are: ultraviolet to near infrared ($1.1 \mu\text{m}$). Their temporal response is in the nanosecond range, which is excellent for a detector. Noise levels are very low, and the presence of internal amplification stages guarantees some of the highest signal-to-noise ratios available in any detector.

All the detectors presented so far are classified as photon detectors. Now, let's turn to thermal detectors.

Thermal Detectors

Pyroelectric detectors

Pyroelectric materials are nonconductors that have the ability to generate a voltage when they are heated or cooled. This change of temperature causes atoms within the crystals of the pyroelectric material to move, changing the electric polarization of the material. This change in polarization induces a voltage. Once the polarization stops changing, the induced voltage becomes zero. One example of a pyroelectric material is potassium tantalate (KTaO_3).

Figure 2-15 illustrates the basic construction of a pyroelectric detector. It consists of a slab of pyroelectric material with electrodes deposited on the surface. The charge on the electrodes corresponds to the polarization of the material (indicated by ellipses with "+" and "-" on their ends) and thus to its temperature. When the temperature of the pyroelectric changes, its polarization changes and the charge on the electrodes changes. This change in electrode charge produces a temporary current through resistor R_L and a voltage drop across it. With some simple circuit analysis, it can be seen that the voltage drop across R_L is equal to the voltage induced across the pyroelectric material. When the temperature stops changing, the polarization within

the pyroelectric material reaches an equilibrium state. This causes the charge on the electrode to stop changing, which causes the current in R_L to drop to zero, indicating that the induced voltage in the pyroelectric material has also dropped to zero. Thus, pyroelectric detectors only respond to the change in detector temperature and cannot be used for direct measurement of CW laser power. For measurement of CW lasers, a rotating mirror may be used to convert the input to the detector into a pulsed input.

Pyroelectric radiometers are useful from the blue end of the visible spectrum through the far infrared for low-power beams. Like other thermal detectors, they have a detectivity that does not change widely with wavelength. Compared to thermal detectors such as bolometers or thermopiles (described later), pyroelectric radiometers tend to have higher values of detectivity. They are most important in IR regions, where other low-light-level detectors cannot be used.

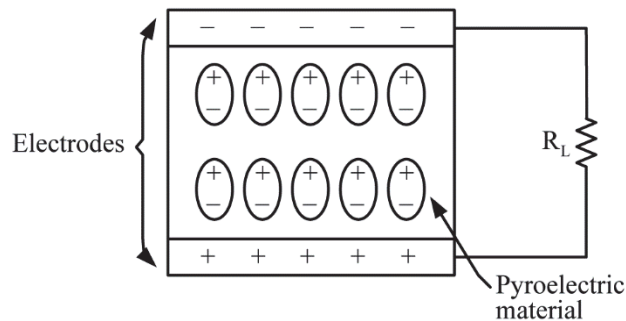

Figure 2-15 Basic construction of a pyroelectric detector

Pyroelectric detectors have fast response times and are capable of responding to short laser pulses.

Bolometers

Bolometers are detectors that measure power by sensing a change of resistance brought about by the heating effect of the laser beam. Bolometers are thus basically temperature-sensitive resistors. Such resistors are usually made of a semiconducting material and are called thermistors. They are not highly sensitive, nor do they have a fast temporal response; however, they are simple, reliable, and inexpensive and are thus used as the sensing element in several power meters. They are useful for CW measurements but, due to their slow time response, are not useful for pulsed measurements.

Thermocouples

A thermocouple is a device that converts a difference in temperature into a voltage. Thermocouples use pairs of metals to effect this conversion; one common pair is copper and constantan (an alloy of copper and nickel). The metals are usually in the form of wires. When one of the junctions between the two metals is at a different temperature than the other, a voltage is generated. The structure of a thermocouple is illustrated in Figure 2-16.

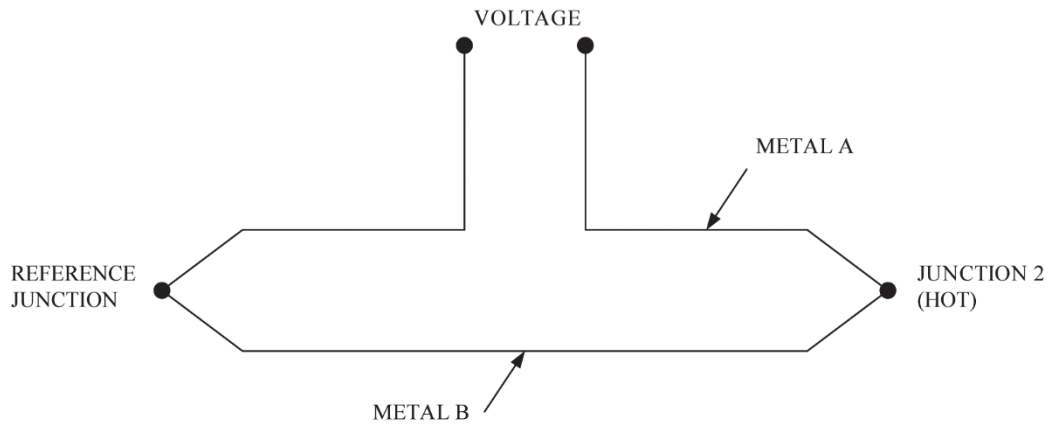

Figure 2-16 A thermocouple

One of the junctions between the two wires (the left junction in the figure) is in contact with a heat sink, which keeps its temperature constant. This junction is called the reference junction. The other junction (denoted “hot” in the figure) is in contact with the absorber. When the laser light is absorbed and heats the absorber, it also heats the junction in contact with the absorber. The voltage resulting from the temperature difference between the two junctions may be measured. The higher the laser’s power, the greater the voltage will be. The voltage can thus be a measure of the laser’s power.

The disadvantage of thermocouples is that the voltage generated by a single thermocouple is small. So in practical thermal power meters, a large number of thermocouples are connected in series. This arrangement is called a thermopile.

Thermopiles

Thermopiles are detectors that measure beam power using the temperature differences induced within the detector by the heating effect of the laser beam. Figure 2-17 is a diagram of a common thermopile for CW laser power measurement. It consists of a metal disk connected to a heat sink at its edge. This heat sink may be either air-cooled or water-cooled. Thermocouples located at the center of the disk and the outer edge are connected in series to produce a voltage that is proportional to the temperature difference from disk center to edge. Laser power output values are correlated to these voltage readings allowing a thermopile to make power measurements. During CW power measurements, the thermopile operates in a steady state with a constant heat flow and a constant temperature difference. When the power changes, new thermal equilibrium conditions must be reached before the reading will be accurate. Thus, the response time of a typical thermopile is greater than two seconds. This is a serious disadvantage when rapid changes in beam power are to be measured.

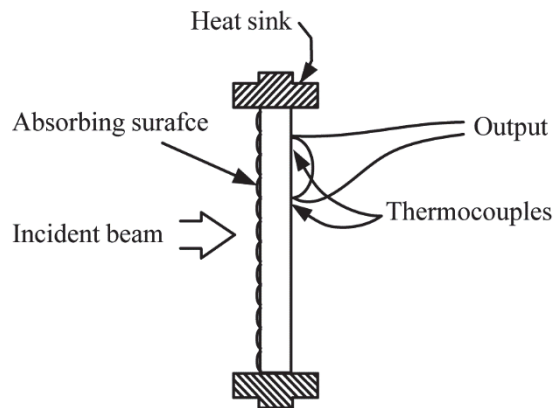

Figure 2-17 *Thermopile for CW power measurement*

Thermopiles are useful for all wavelengths at power levels above one watt. Air-cooled devices are used for powers up to 300 W, and water-cooled models may measure powers of a few kilowatts. Cone calorimeters are also sometimes used for CW power measurement.

In contrast to photon detectors, whose response varies strongly with wavelength and is zero at wavelengths longer than some long-wavelength limit, the spectral response of thermal detectors is almost independent of wavelength over a fairly broad range and can extend well into the infrared.

Measurements

Now that we have a basic understanding of how detectors work, let's turn to the measurement of the important quantities presented earlier in this module that characterize laser output.

CW Power Measurements

Optical power meters are used to measure the power from a CW laser. They are commercially available for use at all laser wavelengths and for power ranges from nanowatts to kilowatts.

All power meters contain the four basic elements shown in Figure 2-18. The light striking the detector causes a current to flow through the detector. When the optical power is within the detector design range, the amplitude of the current is proportional to the total optical power striking the detector. This current is amplified and used to drive the readout device, which may be a microammeter or a digital display. The power range of the readout device normally is selected with a range switch that controls the gain of the internal amplifier.

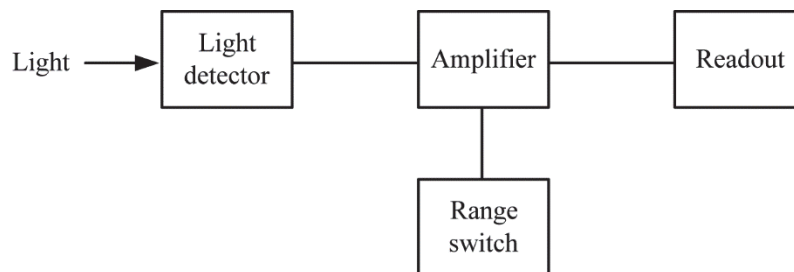

Figure 2-18 *Basic components of an optical power meter*

The optical system of the power meter usually contains elements that control the light striking the detector. These may include a rotating chopper blade that allows only a fraction of the incident laser beam to strike the detector, an ambient light shade to reduce unwanted stray light, and filters to allow only certain wavelengths to pass to the detector.

Most power meters respond with different sensitivities at different wavelengths. They generally are calibrated for a specific wavelength, and calibration curves are used to determine the power at other wavelengths. This will be discussed in more detail later.

Stray Light Compensation

A power meter will provide an accurate measurement only if the light to be measured is the only light that reaches the detector. The technician must either block input from other sources or make corrections for it. Undesired background light is called ambient light or spurious light. It can cause an error in the optical power measurement, especially when a laser with low power is being measured. Ambient light can be reduced in three ways:

1. A reading of the ambient light can be recorded before and after taking the desired measurement. The average value of the before and after ambient light is then subtracted from the laser power measurement.
2. A special switch is provided on some power meters to make it easy to correct for ambient light. A control is used to zero the output reading before each power measurement. This zero adjustment electronically cancels out the signal produced by ambient light.
3. An ambient light shade can be placed on the meter so that only the desired light is allowed to reach the detector. Manufacturers of optical power meters sometimes offer shades designed for this purpose.

The irradiance at the detector must not exceed the detector's design limits. Excessive values can damage detectors. The manufacturer of the detector will usually specify the maximum value of power to which the detector may be exposed. If light with higher irradiance is to be measured, only an appropriately filtered fraction of the light should be allowed to reach the detector.

Suitable attenuators may take various forms. One such form involves a light-diffusing material placed in front of the detector, followed by a chamber with a light-absorbing inner surface and a calibrated aperture. Only a small fraction of the incident light then reaches the detector. For lasers with output in the visible range, ground glass may be a suitable diffusing material. The manufacturer may calibrate the amount of attenuation. A factor of 100 is a common value for attenuation.

Adjusting for Wavelength

Because photoelectric detectors have different response at different wavelengths, a calibration factor must be applied when a power meter is used to measure a laser with a wavelength different from the wavelength at which the meter was calibrated. This correction is less important for power meters that use thermal detectors because the spectral responses of thermal detectors are less critically dependent on wavelength.

A silicon photodetector that converts laser light into an electric current does not respond equally to different wavelengths of light. Figure 2-19 is a graph that shows this wavelength dependency for a typical silicon photocell. The horizontal axis represents wavelength, and the vertical axis represents the correction factor. If the manufacturer calibrated the power meter to give a correct

reading for a helium-neon laser (wavelength 632.8 nm), then when monochromatic light at any other wavelength is incident on the detector, the meter reading must be multiplied by that correction factor to give the proper result.

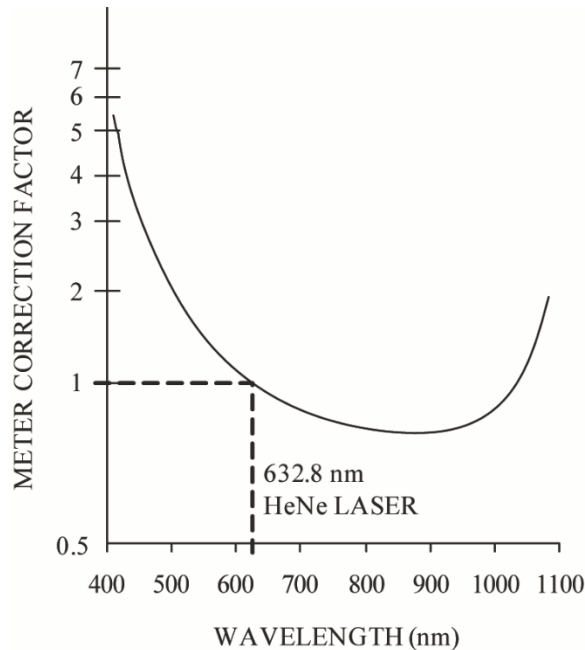

Figure 2-19 Meter calibration curve for a typical silicon-based photoelectric power meter

In certain measurements, a photoelectric power meter needs to respond equally to a large range of laser wavelengths. Specially designed filters can be placed over the detector for this purpose. These filters absorb a given amount of light at selected wavelengths while allowing other wavelengths to pass with very little attenuation. The transmission curve of a filter is similar to the meter correction curve in Figure 2-19. Such a filter is called a *radiometric filter*. An optical power meter with a radiometric filter in place responds approximately uniformly to all wavelengths between 450 and 930 nm. There is no correction factor necessary when light within this wavelength range is incident on the detector.

Pulse Energy Measurements

So far, we have discussed power meters, which are typically used to measure the power of CW lasers. There are power meters that can also measure the average power of a repetitively pulsed laser in which the pulse repetition rate is fairly high (perhaps many kilohertz). However, some lasers are operated at a low pulse repetition rate (or even in single pulse operation), and measurement of average power is not meaningful for these lasers. Thus, it is necessary to be able to measure the energy of individual pulses.

The energy of a laser pulse is most often measured by causing the pulse to be absorbed by a material and then measuring the temperature increase that results from the absorbed laser energy. A device that accomplishes this measurement is called a *calorimeter*.

Calorimetry

Calorimetry is the measurement of heat energy. When heat energy is added to a substance, its temperature increases (assuming there is no change in state, such as from a solid to a vapor).

The temperature rise depends upon the heat capacity and mass of the material and the quantity of heat added. If you know the heat capacity, mass, and temperature rise, you can calculate the energy added to the system. Laser calorimeters respond to the temperature increase of the detector and are calibrated in energy units (joules). The chief factors that affect calorimeter performance are the fraction of total beam energy contributing to the temperature increase and the ability of the sensing element to measure the temperature increase.

Figure 2-20 is an energy-flow diagram that accounts for all the light energy that strikes a calorimeter. The factors identified as loss do not contribute to the temperature increase. All these factors must be accounted for in calibrating a calorimeter. A calorimeter for pulsed energy measurement must allow little of the incident beam to escape unabsorbed, must be designed so that reemitted radiation is minimized or reabsorbed, and must heat slowly by conduction and convection.

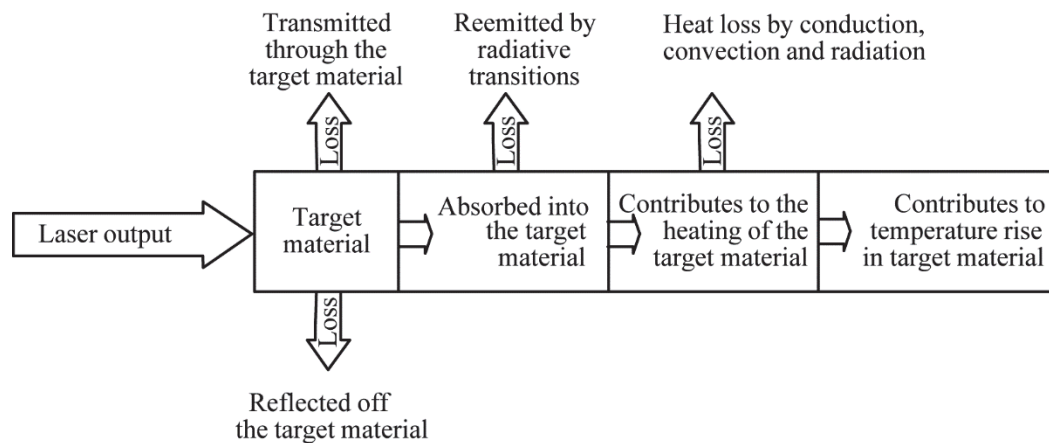

Figure 2-20 “Flow” diagram showing how laser energy incident on a target material causes a temperature rise in the target material

The most common type of calorimeter employs thermocouple junctions to sense the temperature increase of an absorbing element. Figure 2-21 shows the cone calorimeter most often used to measure the energy of a single laser pulse. The calorimeter consists of two hollow metal cones. Thermocouple junctions connected to the cones and wired in series sense temperature difference. The lower cone is the temperature reference and is at room temperature. The laser beam is directed into the upper cone and is absorbed. The cone absorbs most of the laser radiation and reemitted radiation. After several seconds, as heat energy is evenly distributed throughout the input cone, the cone reaches an almost constant temperature. This produces the maximum thermocouple output, and the energy measurement is based on this value. Digital displays automatically record and display the maximum value, expressed in joules. When meter movements are used, the needle moves to a maximum value and then drops as the input cone cools. The pulse’s energy is indicated by maximum needle deflection.

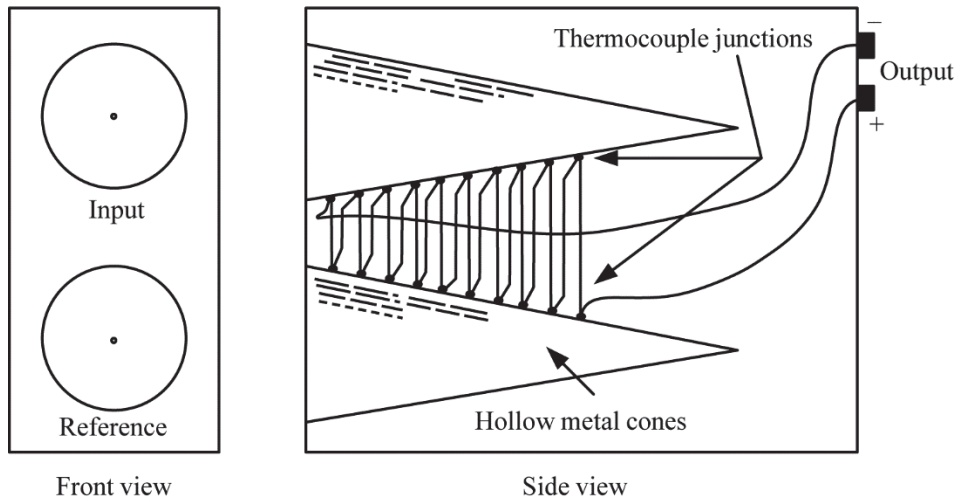

Figure 2-21 *Diagram of a thermoelectric calorimeter*

Most calorimeters respond to a wide range of wavelengths and may be used with a variety of lasers. Measurements are easy and accurate when the entire laser beam and no other radiation enter the calorimeter. Problems arise when only a portion of the laser radiation enters the measuring device or when other radiation is present. Measurements should never be made with the detector located near the laser output aperture, because flashlamp light and fluorescence will influence the results. If beam-handling optics are used to direct the beam into the calorimeter, their effect must be calculated and accounted for in determining pulse energy.

Figure 2-22 illustrates the calibration of an energy monitor installed in a laser system. A beamsplitter directs a small fraction of the laser light to calorimeter A. Calibration is achieved by measuring the total pulse energy with calorimeters A and B and accounting for any losses. The microvoltmeter connected to the calorimeter A is then adjusted to measure total beam energy, and calorimeter B is removed from the system.

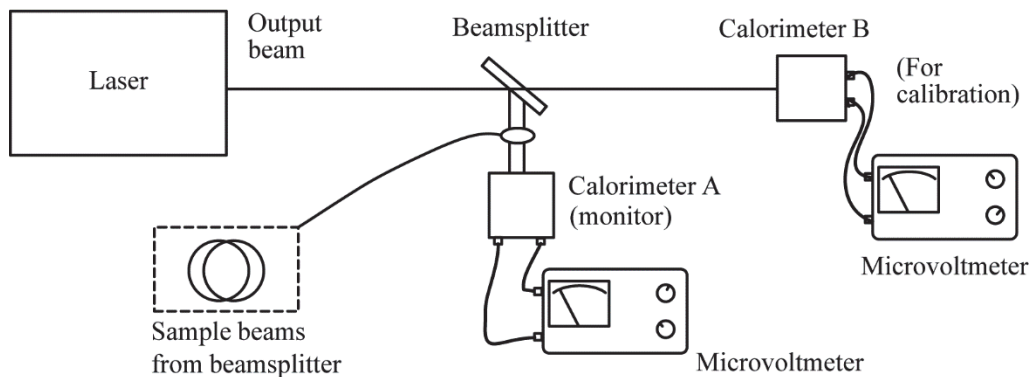

Figure 2-22 *Experimental arrangement for calibration of an energy or power monitor (top view)*

Pulse Duration Measurements

One of the most important properties of pulsed lasers that requires measurement is the pulse duration. To accurately display the time history of a laser pulse, the detector must respond quickly to changes in incident power. For very short pulses—for example, in the picosecond and

femtosecond ranges—none of the detectors described earlier are fast enough to follow the time history of the pulse. For such pulses, technicians use other very sophisticated methods that are beyond the scope of this module. But for longer pulses, from the millisecond to nanosecond ranges, commonly available detectors are fast enough, and detector-oscilloscope combinations are typically used to directly measure pulse durations.

Earlier in this module, we described the inherent time-response capabilities of the various detectors. But a detector's response time is often limited not by intrinsic detector capability but rather by the resistance-capacitance (RC) time constant of the electrical circuit connected to the detector. The capacitance is the capacitance of the detector itself and may be reduced by reducing the detector size. Thus, fast detectors for pulse-shape monitoring are generally small and cannot withstand much input energy. The two detector types used in most cases are the PIN photodiode and the pyroelectric detector.

Photodiodes for Pulse Measurements

A wide variety of fast photodiodes are available for various wavelength ranges from the ultraviolet to the far infrared. UV, visible, and near IR photodiodes operate at room temperature. Those for wavelengths beyond about 2 μm must be operated at cryogenic temperatures.

Figure 2-23 shows some of the optical elements commonly used with photodiodes (and other detectors as well). The laser line filter blocks all light except light whose wavelength is the same as the laser wavelength. The diffuser spreads the incident beam to produce uniform irradiance on the detector surface. The neutral-density filter reduces the irradiance to a level that is within detector limits. The elements used in any particular measurement application depend on the light to be measured. In some cases, the laser radiation has sufficient irradiance to bleach the neutral-density filters, which reduces their absorption and results in detector damage. In such cases, the beam's power must be reduced before the beam enters the detector assembly.

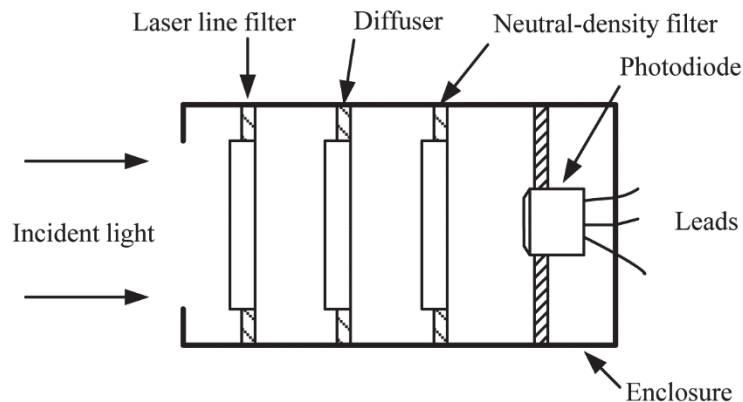

Figure 2-23 *Optical components used with photodiodes*

PIN photodiodes are widely used in modern industry. In the PIN structure (refer back to Figure 2-10), carriers are swept across the intrinsic region very quickly, so the frequency response is very high—higher than that of photodiodes without the PIN structure. PIN photodiodes can respond well to laser pulses with nanosecond duration.

Pyroelectric Detectors for Pulse Measurements

Figure 2-24 shows two types of pyroelectric detectors with different configurations. The direction of the charge polarization P is indicated for each type. In the face-electrode type, the

laser radiation is incident upon the electrode surface. Coatings may be used to enhance absorption. In the edge-electrode type, the radiation is incident directly upon the pyroelectric material.

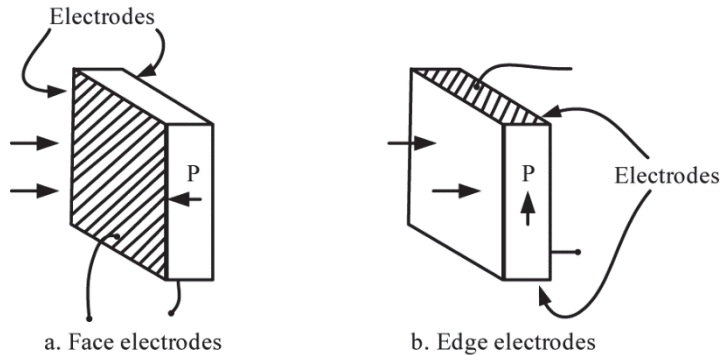

Figure 2-24 Pyroelectric detector types. *P* is the polarization vector.

Figure 2-25 shows the spectral response curves of both types of pyroelectric detectors. Edge-electrode detectors have higher damage thresholds, particularly at short pulse durations. The exact shape of the response curves may be altered by the choice of the coating material. With a semitransparent metallic electrode, the response of the pyroelectric detector with face electrodes may be made almost completely wavelength-independent from 0.2 to 10 μm . The responsivity of such devices may be as high as 100 V/J.

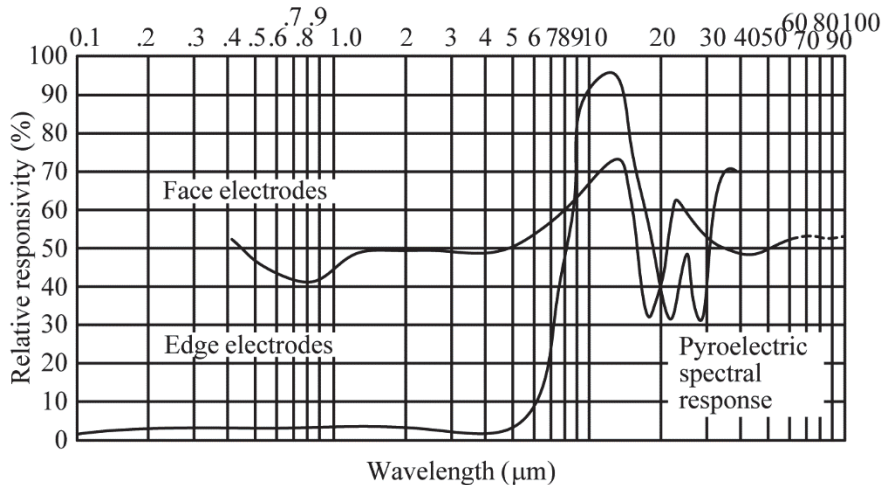

Figure 2-25 Pyroelectric detector spectral response

Pyroelectric detectors have rapid temporal response. They are faster than other types of thermal detectors and can measure the response of short laser pulses in the nanosecond range.

Measuring Laser Beam Divergence

Measurement of laser beam divergence angle is important for predicting the laser's power-per-unit angle at a distance from the laser. As this module explained earlier, the far-field beam divergence of a laser is the constant beam divergence angle at a large distance from the laser output aperture. Near the laser, the beam divergence is not constant. Thus, measurements made in the near field cannot be used

to predict the beam's far-field behavior. This section discusses techniques for measuring beam divergence.

Principles of Beam-Divergence Measurement

The divergence of a CW laser beam can be determined by measuring the beam diameter at two points, as shows in Figure 2-1 and repeated here.

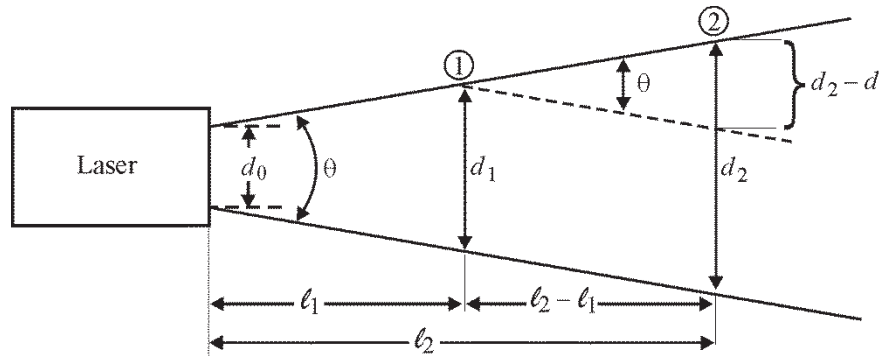

Figure 2-1 Beam divergence of a laser beam

The full-angle beam divergence θ in radians was given in Equation 2-3 and repeated here:

$$\theta = \frac{d_2 - d_1}{l_2 - l_1} \quad (2-3)$$

This equation is valid for small beam divergence angles, which are typical of most lasers. One measures the parameters as shown in Figure 2-1 and applies Equation 2-3.

As an example, if a HeNe laser has a beam diameter of 3.5 mm at a distance of 2 m from the laser and a diameter of 5.9 mm at 4 m, the beam divergence angle is:

$$(5.9 \text{ mm} - 3.5 \text{ mm}) / (4000 \text{ mm} - 2000 \text{ mm}) = 1.2 \times 10^{-3} \text{ radian} = 1.2 \text{ mradian}$$

Beam-divergence measurements for pulsed lasers are based on the same principles as those for CW lasers, although different measurement techniques may be used. For repetitively-pulsed lasers, the techniques are the same as for CW lasers. One can use average power measurements for high repetition rates. The beam divergence of many “single shot” pulsed lasers also may be measured by this technique. This method accurately indicates the beam divergence of any Gaussian beam (see Figure 2-3).

Beam Quality Factor, M^2

A quantity closely related to beam divergence is the so-called beam quality factor, denoted M^2 . This factor gives a quantitative measure of how well a laser beam compares to the ideal Gaussian TEM₀₀ mode. The factor M^2 compares the beam divergence of a given beam to that of a pure Gaussian TEM₀₀ beam with the same beam waist at the same position. If there existed a laser beam that exactly matched a Gaussian profile, its factor M^2 would be unity. For beams that do exactly fit this profile, the value will be greater than unity. For low-power HeNe lasers, M^2 is slightly greater than unity, probably less than 1.05. For higher-power lasers, the value of M^2 may be substantially greater than unity.

The use of M^2 gives a quantitative means to determine the “quality” of a laser beam. It is most useful for beams with a profile close to circular. It is less useful for beams that are not symmetrical, such as those commonly encountered with semiconductor lasers.

The beam from a laser has a minimum beam “waist,” which is the smallest diameter of the beam. Frequently, the beam waist is located inside the laser. The beam diverges from the position of this waist, and its diameter increases with distance from the laser. The factor M^2 basically compares the value of the divergence angle to that of a pure Gaussian mode.

The value of M^2 is given by the equation:

$$M^2 = \pi\theta(2w_0)/4\lambda \quad (2-16)$$

Where $2w_0$ is the diameter of the beam at its waist, θ is the full angle of beam divergence in the far field, and λ is the wavelength. We note that M^2 is a dimensionless quantity. Also, for a Gaussian beam, w_0 represents the radius at which the irradiance has fallen to $1/e^2$ (13.5%) of its peak value (see Figure 2-3).

M^2 may be determined by measuring the diameter of the beam waist $2w_0$ and the far-field divergence angle. The divergence angle may be measured using the method described earlier. But, it is more difficult to measure the diameter of the beam waist, which is often inside the laser. It is possible to determine the diameter of the beam waist by measuring the diameter of the beam at different distances from the laser, but this requires very careful measurements. We have:

$$(2w_0)^2 = D_z^2 - (\theta z)^2 \quad (2-17)$$

Where D_z is the diameter of the beam at distance z from the laser. But this measurement is difficult because the beam waist diameter is relatively small, often only a few millimeters, whereas the other quantities become large as one moves farther from the laser. Thus, the measurements must be very accurate.

The manufacturer of a laser will often specify the value of M^2 for the laser.

Spectral Measurements

Spectroscopy is an important tool for analyzing the wavelength dependent characteristics of lasers. And it is highly useful for other applications in which lasers are used, such as analysis of the composition of materials and interpretation of the results of laser-induced photochemistry.

Although many lasers have a single, well-defined wavelength, some have a number of different modes with slightly different wavelengths. In characterizing a laser, it is important to know how the output of the laser is distributed among these wavelengths. Likewise, there are lasers that are tunable to a number of different output wavelengths. Measuring the output at these different wavelengths makes it possible to assess these lasers’ operational effectiveness.

The instrument that is used for these wavelength measurements is a spectrometer, also called a spectrograph or spectroscope. A spectrometer is an instrument used to measure the wavelength of light in a specific portion of the electromagnetic spectrum. There are a wide variety of spectrometers that use different physical principles to assess the wavelength components of a light source. We will not discuss all these physical principles. Instead, we will focus our attention on diffraction—the principle most commonly used in modern spectrometers—and on optical elements called diffraction gratings.

Diffraction gratings are apertures consisting of thousands of slits separated by equal spaces. Light that either reflects off these slits or is transmitted through them acts as a point source that creates diffraction patterns that generate spaced fringes, as shown in Figure 2-26.

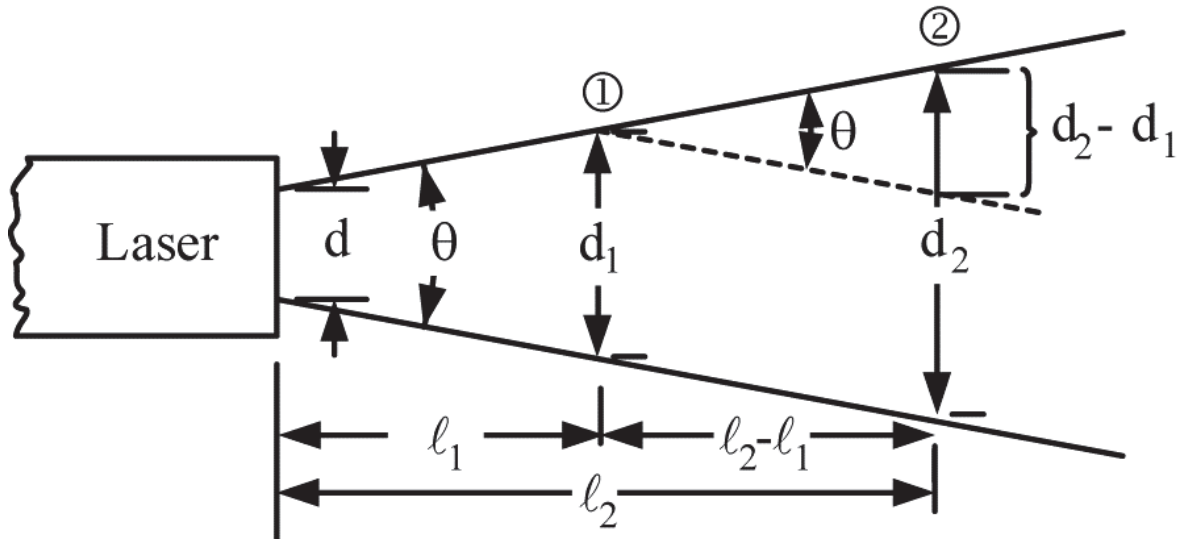

Figure 2-26 Diffraction of light through a transmission grating

For incident light that is normal to the surface of a diffraction grating, the location of these ordered fringes on the screen is given by Equation 2-18. This equation is applicable for either a transmission or reflection grating.

$$a (\sin \theta_p) = m\lambda \quad (2-18)$$

Where a = distance between slit centers

θ_p = angle measured from the symmetry axis, locating the m th-order fringe

m = is the order of the fringe: 0, ± 1 , ± 2 , etc.

λ = wavelength of light

Equation 2-18 shows that the direction of the light (θ_p) leaving a diffraction grating depends on the light's wavelength, with longer wavelengths spreading out further along the screen than shorter wavelengths.

Most spectrometers use reflection gratings. Reflection gratings consist of many thousands of fine slits (grooves) ruled on a reflecting surface. Light that reflects off these grooves is diffracted according to equation 2-18, with different wavelengths of light dispersing in different directions.

Figure 2-27 shows schematically the basics of a spectrometer that uses a reflection grating. The curved grating is rotated so that different wavelengths of light can reach the exit slit. This rotation allows the light's various wavelength components to interact with the detector. The detector measures the intensity of the light for each wavelength and delivers the information to

the control module, which analyzes the results, stores them and generates a graphical display of the results.

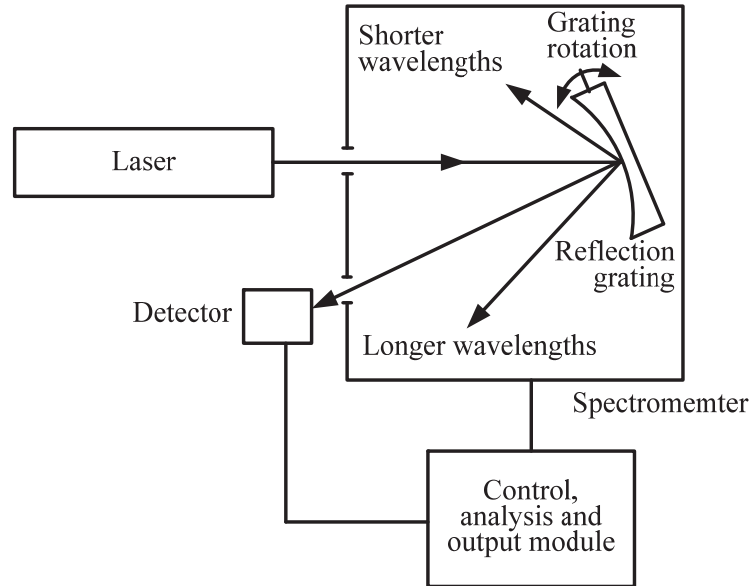

Figure 2-27 Schematic of spectrograph that uses a reflection grating

Grating-based spectrometers are useful over a broad range of wavelengths, from nanometers to tens of micrometers.

Beam Profilers

We have described methods for finding quantities such as the beam divergence angle, which requires the measurement of certain parameters as shown in Figure 2-1 and the use of Equation 2-3. It is important for technicians to understand these methods because they define what beam divergence really is. However, once a technician has this basic understanding, the emphasis in making measurements shifts to speed and accuracy. A device that delivers these efficiencies is an automated laser beam profiler.

Using a beam profiler, it is possible to obtain automated measurements of the beam power or energy, the power or energy density, the intensity profile across the wave front, the beam divergence angle, the value of M^2 , the beam waist location, the beam waist diameter, and other parameters. The profiler is inserted into the laser beam, where it gathers the relevant data. It then processes this data and presents the selected parameters in a display. The display may present the results in a variety of ways, which the user can select. Displays of a wave front's irradiance profile may include:

- Contour maps in color or in grey scales to show intensity levels,
- Cross sectional profiles, which are cuts through a particular beam axis, or
- Isometric views showing a three dimensional display of the wave front.

Laser beam profilers can employ a number of different types of measurement approaches, including:

- Arrays of photodetectors. A two-dimensional array of detectors, up to 64×64 detectors, measures the light in the wave front, digitizes the results, sends the data to a computer for processing, and presents the data on a display in a format chosen by the user. Arrays are usually either silicon or pyroelectric detectors.
- Scanning slits. A narrow slit is mounted on a rotating drum, with a detector behind the slit. The power transmitted through the slit is measured, and the computer processes the results as a function of position.
- Scanning pinhole. A pinhole much smaller than the beam diameter is scanned over the wave front. A detector behind the pinhole measures the transmitted light as a function of position.
- Scanning knife edges. A knife edge is scanned across the wave front, and the detector behind it records the variation in transmitted light as a function of the position of the edge.

Models of all these types of profilers are available from a variety of manufacturers. As is typical, the capabilities of these profilers vary from one manufacturer to another. It is not possible here to summarize all the different instruments currently on the market. However, it is worth noting that beam profilers have many different measurement options, including capabilities within different ranges of wavelength and different limits as to the amount of power/energy they can measure. Because of the wide variety of lasers available, no single beam profiler can measure every potentially desirable characteristic.

Before using a commercial beam profiler, the technician must study the manufacturer's equipment instruction manual carefully. Before choosing a particular model of beam profiler to purchase, the user must carefully consider the properties of the different models available in relation to the requirements of the application where it is to be used.

Summary

A variety of different types of detectors are available for measuring laser output characteristics. Photodiodes are used in the ultraviolet, visible, and near IR portions of the spectrum. Photomultiplier tubes are used in the same regions for the measurement of very low light levels. Thermocouples and thermopiles are used throughout the entire spectral range of laser operation. Their primary disadvantage is their slow response time. Pyroelectric detectors may be used throughout the visible and the infrared regions.

The output powers of CW lasers can be measured using a variety of types of power meters, depending on the output power level and the laser wavelength. Pulse duration is measured by detectors with fast temporal response rates, such as photodiodes or pyroelectric detectors.

Beam divergence is calculated by measuring a beam's diameter at different distances from the laser. Finally, beam profiling instruments can easily and rapidly characterize laser beams.

Laboratory

Laboratory 2-2: Measuring Laser Output Characteristics

Purpose

When students complete this lab, they should be able to:

- Use proper safety procedures related to HeNe or diode lasers.
- Inspect a laser.
- Operate a power meter.
- Measure the beam power of a laser.
- Measure the focused beam power of a laser.
- Measure the beam profile of a laser.
- Measure the divergence of a laser beam.
- Measure the divergence of a laser beam at a focal point.

Safety Precautions

Before you turn on any laser, you must do the following two things. First, be certain that everyone in the area is wearing the correct laser eye protection—that is, laser safety goggles or laser safety glasses. Second, inspect the laser so that you understand as much as possible about its operation.

Equipment

1. HeNe laser or diode laser pointer
2. Firm mount for HeNe and diode laser
3. Coherent optical power meter
4. Focusing lens with known focal length
5. Linear translator with micrometer
6. Adjustable lens mount
7. Sharp-edged blade, lab jacks, and meter stick
8. 3" x 5" index card

Pre-Lab Familiarization

A. Review safety procedures

Your instructor will give you an overview of the safety considerations for this laboratory and

will provide the necessary eyewear—glasses or goggles.

B. Inspect the laser

Sometimes lasers are completely sealed, which makes it difficult to determine what the constituent parts are and what those parts are doing during lasing action. However, it is very important to visually inspect the laser before you turn it on. Even if the laser you are operating is a very low power laser pointer, you will want to look at it to determine where the beam comes out and in which direction to point the laser.

Procedures

Measurement 1: Beam Power

1. Follow all safety guidelines when operating the laser.
2. Review the user manual for the laser, and record its wavelength in Data Table 1.

Data Table 1

Laser Wavelength in nm	
---------------------------------------	--

3. Review the power meter's user manual and determine the proper procedure for setting the power meter to the laser output wavelength. Set the power meter to the laser output wavelength.
4. With the laser turned off, place the power meter detector at the output aperture of the laser and measure a baseline reading for the power meter. Record this reading in Data Table 2.

Data Table 2

Distance of Detector from Laser	Power Meter Reading (W)
Laser Off	(Baseline Power)
Laser at 2 cm	(P_1)
Laser at 1 m	(P_2)
Laser at 2 m	(P_3)
Average Power	$(P_{av} = [P_1 + P_2 + P_3]/3)$

5. Place the detector of the power meter in the beam path of the laser at a 2 cm distance from the laser output aperture.
6. Turn on the power meter.
7. Turn on the laser.
8. Record the power reading in Data Table 2.
9. Repeating steps 5 – 8, take two additional measurements at one meter and 2 m from the output aperture of the laser.

10. Calculate the average power, and record this value in Data Table 2.

Measurement 2: Focused Beam Power

1. Use the experimental setup for Measurement 1. Place a converging lens in the beam path.
2. Use the 3" x 5" index card to locate the lens focal point. Place the card in the beam path just past the lens. Move the card away from the lens until the beam diameter appears to be at its smallest point. Record this distance in Data Table 3a.

Data Table 3a

Focal Length of Lens	
-----------------------------	--

3. Measure the power at this spot according to the instructions in steps 5 – 8 in Measurement 1. Record the reading in Data Table 3b.

Data Table 3b

Distance From Laser	Power Meter Reading
Laser Off	(Baseline Power)
At lens focal point—(l_1)	(P_1)
Just before the focal point—(l_2)	(P_2)
Just after the focal point—(l_3)	(P_3)
Average Power	($P_{av} = [P_1 + P_2 + P_3] / 3$)

4. Measure the power at a distance just before the focal point of the lens. Record in Data Table 3b. Measure the power at a distance just after the focal point of the lens. Record in Data Table 3b.
5. Calculate the average power, and record this value in Data Table 3b.

Measurement 3: Beam Divergence

Use the Diagram below to measure the beam divergence. All measurements are taken in the far field.

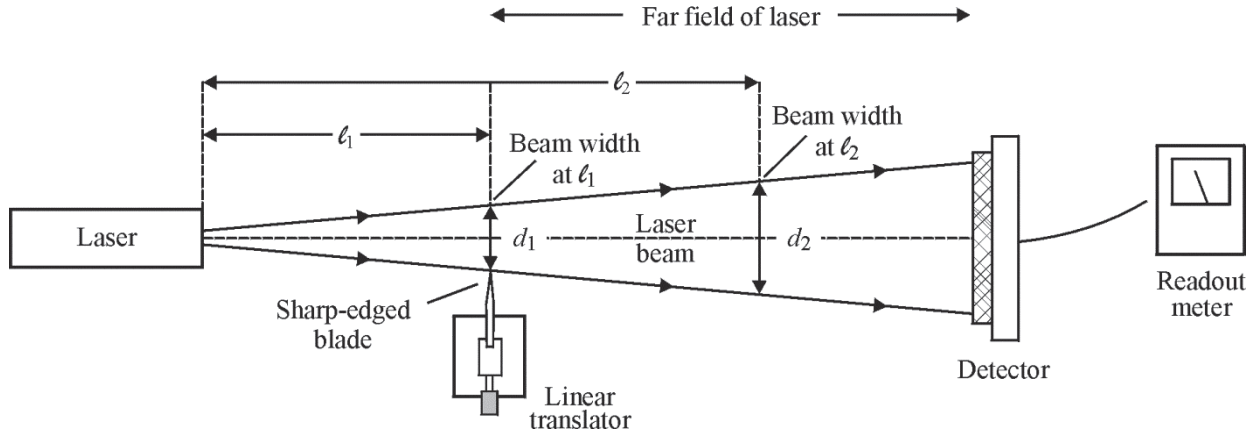

1. Set up the laser, power meter and linear translator according to the diagram above and these instructions:

Mount the sharp-edged blade on a linear translator such that the blade can be moved slowly across the laser beam by turning the adjusting micrometer screw. The laser, linear translator, and detector head are mounted on lab jacks and aligned such that the laser beam, razor blade edge, and detector are in a straight line, as shown in the figure above. Perform all measurements of the beam width in the far field.

2. Turn on the power meter.
3. Measure a distance for l_1 and record in Data Table 4.

Data Table 4

Position of Knife Blade	Micrometer Reading	Power on Detector	$1/e^2$ Position on Left	$1/e^2$ Position on Right	Beam Diameter	Beam Divergence $\theta = \frac{d_2 - d_1}{l_2 - l_1}$
$l_1 =$						
			=	=	$d_1 =$	
$l_2 =$						
			=	=	$d_2 =$	$\theta =$

4. Turn the micrometer screw until the knife blade completely blocks the laser beam. The reading on the power meter is zero or the baseline value found in Measurement 1.
5. Slowly turn the micrometer until the power meter shows a small increase in power.
6. Record the micrometer position and the power reading in Data Table 4.
7. Slowly, in regular increments, turn the micrometer in the same direction as in step 5. Record the power reading and micrometer position for each increment in Data Table 4.
8. Continue the process in step 7 until the power meter reaches a maximum. Plot a graph of *power readings* versus *micrometer readings*. NOTE: The graph can be completed by tracing a mirror image of the plotted graph. See example below.

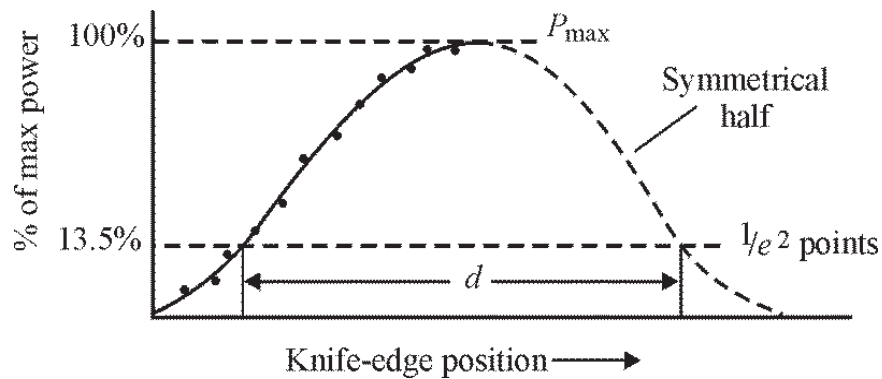

9. Perform steps 3 – 8 for the position l_2 .
10. For the graphs at l_1 and l_2 , measure the distance on the graph that corresponds to the $1/e^2$ (13.5% of maximum) points as shown on the graph above. These values correspond to the diameter of the beam (d_1 and d_2) at l_1 and l_2 respectively.
11. Use the equation in Data Table 4 to calculate the beam divergence “ θ .” Record the values in Data Table 4.

Measurement 4: Beam Divergence at a Focal Point

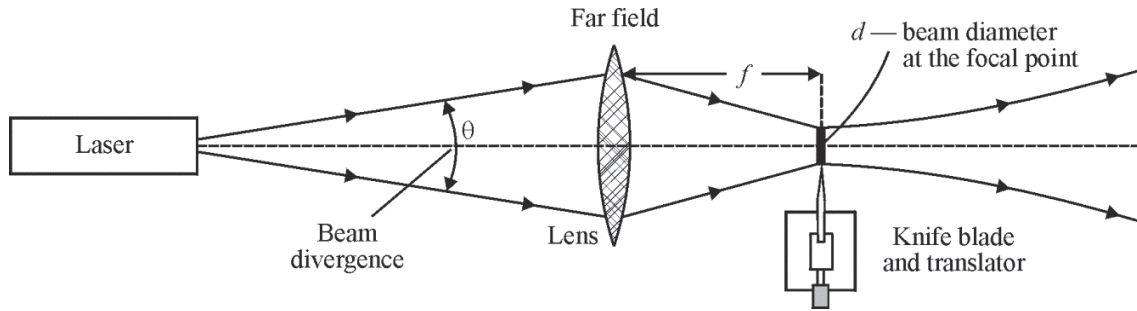

1. Place a lens in the beam path as shown in the above diagram.
2. Place the micrometer and blade setup at the focal point. You determined this distance in Step 2 of Measurement 2.
3. Perform steps 3 – 8 of Measurement 3, recording results in Data Table 5.
4. Determine the value for d using the directions in step 10 of Measurement 3.
5. Use the equation $f = d/\theta$ to determine the beam divergence. Record this value in Data Table 5.

Data Table 5

Position of Knife Blade	Micrometer Reading	Power on Detector	$1/e^2$ Position on Left	$1/e^2$ Position on Right	Beam Diameter
1 =					
			=	=	$d =$

Beam Divergence θ	
-----------------------------	--

WORKPLACE SCENARIO

Here is your opportunity to use the concepts you have learned in this module to solve an actual problem that could arise in a photonics company. Your instructor will provide directions for developing a solution.

Measuring Output Characteristics of Lasers

Scenario

Research and provide the equipment specifications required for measuring the following laser output characteristics. Based on these equipment specifications, research the available equipment options and select a particular equipment type that you would recommend purchasing for this measurement. Also include a description of the measurement and expected results:

- Power output of a 75 W CO₂ laser
- Spectrum analysis of a 2 W argon-krypton laser
- Pulse energy and repetition frequency of a CW pumped, mode locked fiber laser
- Beam profile (including divergence & M² measurements) of a 4 W DPSS Nd:YAG laser
- Irradiance of an arc-lamp CW Nd:YAG laser, using a 75 mm focal length lens

Additional Information

You can find the information you need to solve this problem from at least three sources:

1. An explanation of the laser output characteristics can be found in Module 2-2, *Laser Output Characteristics*.
2. You can conduct an Internet search of “laser measurement tutorials.”
3. Devices and equipment to use for each measurement may be found online or in your department files.

Problem and Tasking

For each required measurement:

1. Determine predicted output values.
2. After you have determined the approximate output values, search for the necessary devices and equipment.
3. Prepare a diagram of the measurement that shows the optical axis and placement of devices and equipment.
4. Describe the measurement process and the expected accuracy of your measurement.

PROBLEM EXERCISES AND QUESTIONS

1. Describe the function and applications of the following types of detectors, using diagrams as appropriate.
 - a) Photoconductive detectors
 - b) Photodiodes
 - c) Vacuum photodiodes
 - d) Photomultipliers
 - e) Pyroelectric detectors (including the two different types and the relative advantages and disadvantages of each type).
 - f) Bolometers
 - g) Thermopiles
2. Discuss the differences between photon detectors and thermal detectors.
3. Discuss the responsivity and detectivity of optical detectors, and give units for each.
4. Describe transverse electromagnetic modes, with special emphasis on the Gaussian mode.
5. Given the focal length of a focusing lens and the divergence angle of a laser beam, how would you calculate the approximate diameter of the spot of focused light?
6. Draw a flow diagram for all energy incident on a target material, and identify the factors that contribute to energy loss (energy that does not contribute to temperature rise).
7. Draw the experimental setup for measuring the beam divergence of a CW laser beam, and describe how to obtain the necessary data and determine the beam divergence angle.
8. Discuss the beam quality factor M^2 , including the equation that defines it.
9. Describe the applications of beam profilers.

REFERENCES

- Coherent, Inc. 2013. Beam Diagnostics: Meeting the Need for High Quality. In *The Photonics Handbook*. Pittsfield, MA: Laurin Publishing.
<http://www.photonics.com/edu/Handbook.aspx?AID=25162> (accessed October 25, 2013).
- John R. Gilchrist. 2013. Spectroscopy: The Tools of the Trade. In *The Photonics Handbook*. Pittsfield, MA: Laurin Publishing. <http://photonics.com/edu/Handbook.aspx?AID=25118> (accessed October 25, 2013).
- Luxon, James T. and David E. Parker. Chapter Title. In *Industrial Lasers and Their Applications*, xxx-xxx. Englewood Cliffs, NJ: Prentice-Hall.
- Morse, Mike. 2007. Germanium on Silicon Approaches III-V Semiconductors in Performance. *Laser Focus World*, May. <http://www.laserfocusworld.com/articles/print/volume-43/issue-5/features/semiconductor-detectors-germanium-on-silicon-approaches-iii-v-semiconductors-in-performance.html> (accessed October 25, 2013).
- Norton, Paul. 1995. Photodetectors. Chapter 15 in *Handbook of Optics*, ed. Michael Bass. New York: McGraw-Hill.
- Ready, John F. 1997. Chapter 5 in *Industrial Applications of Lasers*. San Diego: Academic Press.
- Wright, Tony, and Mike Avery. Photomultiplier Tubes Present Both Challenge and Opportunity. *Laser Focus World*, June.
<http://www.laserfocusworld.com/articles/print/volume-43/issue-6/features/photomultiplier-tubes-photomultiplier-tubes-present-both-challenge-and-opportunity.html> (accessed October 25, 2013).

INDEX OF TERMS

B

Beam diameter, 6, 26
Beam divergence, 3, 25
Beam profilers, 29
Beam quality factor, 26
Beam waist, 4, 27

C

Calorimeter, 21
Coherence length, 3
Coherence, 3

D

Detectivity, 10
Diffraction-limited beam divergence, 5

F

Far-field divergence, 5, 25

N

Near-field divergence, 5, 25

O

Optical detectors, 9, 29
Optical power meter, 19

P

Photon detectors, 10, 11, 24
Pulse train, 8
Pulsewidth, 8

R

Radiometric filter, 21
Responsivity, 10

S

Spectroscopy, 27
Spot size, 7

T

Thermal detectors, 10, 16, 25

W

Work function, 11

Laser Types and Their Applications

Module 2-3

of

Course 2, *Laser Systems and Applications*
2nd Edition

OPTICS AND PHOTONICS SERIES



OP-TEC

National Center for Optics and Photonics Education



© 2016 University of Central Florida

This material was developed by the National Center for Optics and Photonics Education, OP-TEC, and is based upon work supported by the National Science Foundation under Grant No. 1144377 and completed under Grant No. 1303732. Any opinions, findings, and conclusions or recommendations expressed in this material are those of the author(s) and do not necessarily reflect the views of the National Science Foundation.

For more information about the text or OP-TEC, contact:

Dan Hull
PI, Executive Director, OP-TEC
316 Kelly Drive
Waco, TX 76710
(254) 751-9000
hull@op-tec.org

Published and distributed by

OP-TEC
316 Kelly Drive
Waco, TX 76710
254-751-9000
<http://www.op-tec.org/>

ISBN 978-0-9983480-2-5

CONTENTS OF MODULE 2-3

Introduction	1
Prerequisites	1
Objectives	2
Basic Concepts	2
Laser Materials, Excitation, Structure, and Output	2
Groups of Lasers	3
Wavelength Tuning, Shifting, and Harmonic Generation	5
Laser Packaging	9
Laser Types	11
Gas Lasers	11
Solid State Lasers	20
Fiber Lasers	31
Semiconductor Lasers	36
Other Lasers and Laser-Like Sources	46
Present Laser Applications	49
Lasers in Communications	49
Lasers in Manufacturing	50
Lasers for Semiconductor Photolithography	52
Measurement Applications and Remote Sensing	53
Laser Medical Treatment	54
Lasers for Research and Laboratory Measurement	55
Laser Reading, Scanning, Writing, Projection, and Holography	55
Military Lasers	56
Lasers for Adaptive Telescope Optics	57
Future Laser Applications	57
Long-Term Projects and Big Challenges	57
Summary	59
Troubleshooting	65
Workplace Scenario	68
Problem Exercises and Questions	70
References	74
Index of Terms	75

Module 2-3

Laser Types and Their Applications

INTRODUCTION

The prerequisites for this module have given you a foundation for understanding the basic principles of laser operation. The ways these principles are applied to specific laser types depend on the materials that form the laser medium, the type of pumping source, the laser-cavity geometry, and the required output characteristics. Because of all these variations, there are many different types of lasers that operate in different ways and generate light at different wavelengths and power levels.

In this module, we examine some of these different laser types. As you will see, these different types vary tremendously in many ways. Lasers range in size from semiconductor chips the size of a grain of sand to assemblies of optics the size of a building. They emit beams of infrared, visible, and ultraviolet light, although no one device emits over that whole range. The beam may be continuous, or it may be a series of pulses lasting from milliseconds to a few femtoseconds (10^{-15} s). The power in the beam may range from a fraction of a milliwatt, visible as a spot on the wall, to tens of kilowatts, able to slice through steel plates.

To help you understand this diverse array of lasers, we start by looking at the types of materials and structures used to make them. Next, we describe how these materials and structures are used in various combinations to fashion several currently available laser types. We provide a brief description of how each type of laser operates and produces laser output. Finally, we explain the applications of these laser types in various technology fields and look into the future at lasers currently under development.

PREREQUISITES

OP-TEC's *Fundamentals of Light and Lasers Course*

OP-TEC's *Laser Systems and Applications Course, Module 1: Laser Q-Switching, Mode Locking, and Frequency Doubling and Module 2: Laser Output Characteristics*

Understanding of high school level trigonometry and algebra concepts, including exponentials and logarithms

OBJECTIVES

Upon completion of this module, the student should be able to:

- Identify major types of laser systems and explain how they differ.
- Identify which laser systems are used in various technology areas.
- Understand why some lasers are appropriate for certain applications.
- Categorize lasers according to gain medium, output wavelength, and applications.
- Select one or two lasers that are suitable for a particular application.
- Read and understand specifications for commercially available lasers and systems that incorporate a laser.
- Describe the facility, utility services, and safety requirements for installing a commercially available laser or system that incorporates a laser into an industrial, commercial, or laboratory setting.
- Understand and apply Tables 3-9, 3-10, and 3-11 in this module.

BASIC CONCEPTS

Laser Materials, Excitation, Structure, and Output

Lasers can be made of gases, solids, or liquids that can be excited to create the population inversion needed to produce stimulated emission. This means that the material must have suitable energy levels, excitation energy must be able reach the atoms and molecules, and input energy must selectively excite the atoms or molecules to the right energy levels.

Consider, for example, the first laser material, synthetic ruby, made by adding chromium to aluminum oxide. Crystalline aluminum oxide is transparent and so allows light to reach the chromium atoms, exciting those atoms' electrons to a state that drops to the upper laser level, which can be stimulated to emit red light. The light-emitting chromium atoms are embedded in a material that transmits both the pump or excitation light and the light emitted by the chromium atoms, as shown in Figure 3-1. The ruby laser would not work if the crystal was opaque. Nor could an electric current excite it, because ruby is nonconductive.

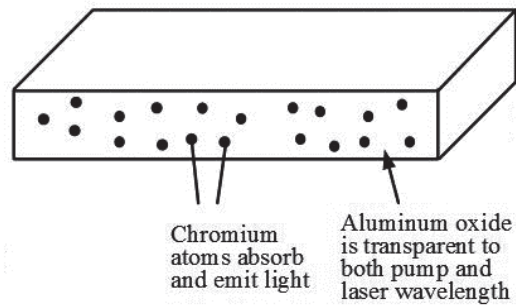

Figure 3-1 Ruby crystal

Gases can both transmit light and conduct an electric current, but in most cases, electrical excitation works best. The electrons may excite the laser species directly, or they may excite another species that transfers energy to the laser species. Semiconductors can transmit both light and current, but the details of their laser operation are complex and are described in detail later.

Lasers often are long, thin rods or gas-filled tubes with mirrors on their ends, but many other structures are possible, depending on the optical and physical properties of the laser. Long rods or tubes are needed for materials with low gain per unit of length, and they typically have highly reflective mirrors. High-gain materials can be much smaller: the most common semiconductor lasers are the size of a grain of salt. The laser structure also may be chosen to ease the dissipation of waste heat. Laser output can vary between continuous and pulsed modes.

Lasers also vary in their efficiency in producing light. An important parameter used to define this efficiency is the *wall-plug efficiency* (also called the *radiant efficiency*). The wall-plug efficiency is a laser's efficiency at converting electrical power into optical power. It is defined as the ratio of the total optical output power to the input electrical power.

All lasers have in common some basic processes: pumping, population inversion, and stimulated emission. However, different lasers implement these processes in drastically different ways, which results in the wide diversity of lasers that are now in common use. To bring some sense of organization to this diversity, we look for some common features between these lasers. One feature that allows us to group lasers into categories is the active (light-emitting) material they use in generating their laser light.

Groups of Lasers

The primary classification of lasers for many purposes—including for this course—is by the physical state or structure of the active material. The primary categories this course uses are:

- *Gas lasers*: the active material is a neutral or ionized gas or a hot vapor of a material that is solid at room temperature (such as a metal-vapor laser).
- *Semiconductor lasers*: the active material is a semiconductor.
- *Diode lasers*: semiconductor lasers that are electrical diodes—by far the most common semiconductor lasers.
- *Solid state lasers*: the active material is a crystalline or glassy solid that does not conduct electric current. (Note that in the laser world, unlike in electronics, a semiconductor or

diode laser is not called a solid state laser, and “solid state” does *not* mean “semiconductor.”)

- *Fiber lasers*: solid state lasers in which the active material is an optical fiber. Technically, fiber lasers are solid state lasers, but the difference between fiber lasers and other solid state lasers matters in practice.
- *Liquid lasers*: the active material is a liquid. (The only example in practical use is the dye laser, so they also are called *dye lasers*.)

These categories usually are easy to identify, but some lasers are treated as “black boxes” and not identified by material type. We will talk about those later. Now, let’s look at other classification descriptors involving the structure of the laser, its excitation techniques, and its output characteristics.

Other Laser Classifications

Lasers can be classified in several other ways: by light-emitting atom or molecule, excitation technique, output wavelength, output duration or pulse length, pulse repetition rate, power level, tunability and bandwidth, or the use of harmonic generation. The choice usually depends on what’s most important to the user. If your application requires pulses lasting one picosecond, then you look for lasers with a particular pulse duration. If you need a visible green beam, you sort lasers by wavelength.

Lasers often are identified by the element or compound that emits light. This method of identification is particularly useful once you know lasers, because the light-emitting substance usually indicates the laser’s power, wavelength, and other operating characteristics. Ruby lasers, for example, emit pulses of red light at 694 nm. Helium–neon lasers emit continuous milliwatt-level beams of red, orange, or green light.

We describe specific light-emitting atoms and molecules later in this module. Here, we briefly describe other ways of classifying lasers.

- *Pulsed vs. continuous wave*: Tells if the laser emits a continuous beam or pulses, which are usually emitted at regular intervals.
- *Pulse type*: Typically identified by time duration (millisecond, microsecond, nanosecond, picosecond, or femtosecond) or by the pulse-generation technique, such as Q switching or mode locking.
- *Wavelength*: Either the wavelength or the part of the electromagnetic spectrum within which the laser output is emitted.
- *Power level*: For continuously emitting lasers, the power level is the continuous beam power in watts. For pulsed lasers, the power level is either the average or the peak power in watts (the manufacturer should indicate which measure it uses). Power level is sometimes described by pulse *energy* in joules. Power level is crucial for applications. Milliwatt lasers illuminate; kilowatt lasers cut.

- *Excitation mechanism:* How the laser medium is excited: electrically (by current), optically (by light), or chemically (by a chemical reaction). Optically pumped lasers, in turn, are lamp pumped, diode pumped (with a diode laser), or laser pumped (by some other laser).

Wavelength Tuning, Shifting, and Harmonic Generation

Most—if not all—of the lasers you have seen emit at a single fixed wavelength or in a narrow band that looks like a single color. However, as you have already learned, some lasers can be tuned or adjusted to emit a range of wavelengths. This can be done in various ways for different lasers, and because it’s an important feature that differs among lasers, it deserves a closer look.

Tunable Lasers and Wavelength Selection

As you have learned, a laser cavity resonates at a series of wavelengths determined by the number of waves that fit exactly within one cavity round-trip; each of those wavelengths is a separate longitudinal mode. Recall also that the round-trip gain of the laser medium is spread across a range of wavelengths, as shown in Figure 3-2.

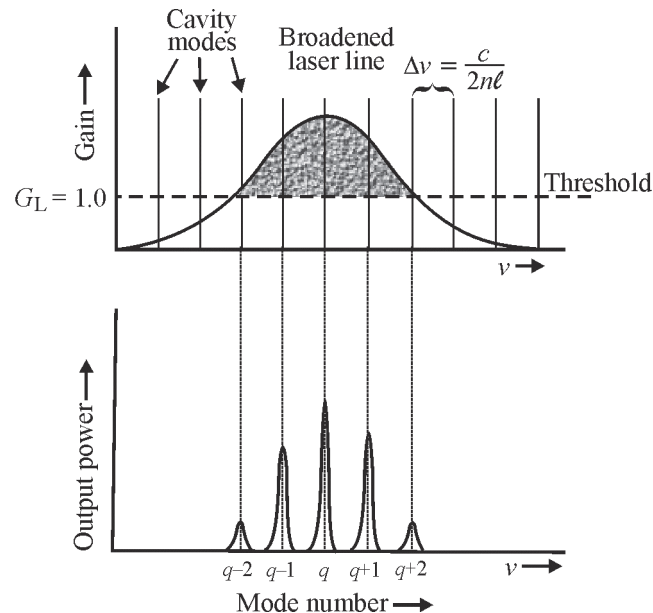

Figure 3-2 Spectral distribution of laser output showing several longitudinal modes with various loop gains G_L

This multi-longitudinal-mode spectrum appears in some important lasers, including helium-neon gas lasers and some semiconductor diode lasers. However, other lasers have rather different emission spectra because their gain bandwidth and cavity optics differ in important ways from this simple model.

The example in Figure 3-2 shows a laser that has a positive gain across several longitudinal cavity modes. Typically, the laser transition is a very narrow band between two distinct energy levels, as shown in the left side of Figure 3-3. However, some laser transitions occur between broad energy bands, as shown on the right side of Figure 3-3. These may be a series of energy states so closely spaced that they blur together, so the laser can emit at a much broader range of wavelengths—tens of nanometers or even over 100 nm in the visible and near-infrared ranges.

(Usually, these bands appear in molecules or crystals rather than in atomic gases as in the helium–neon laser.)

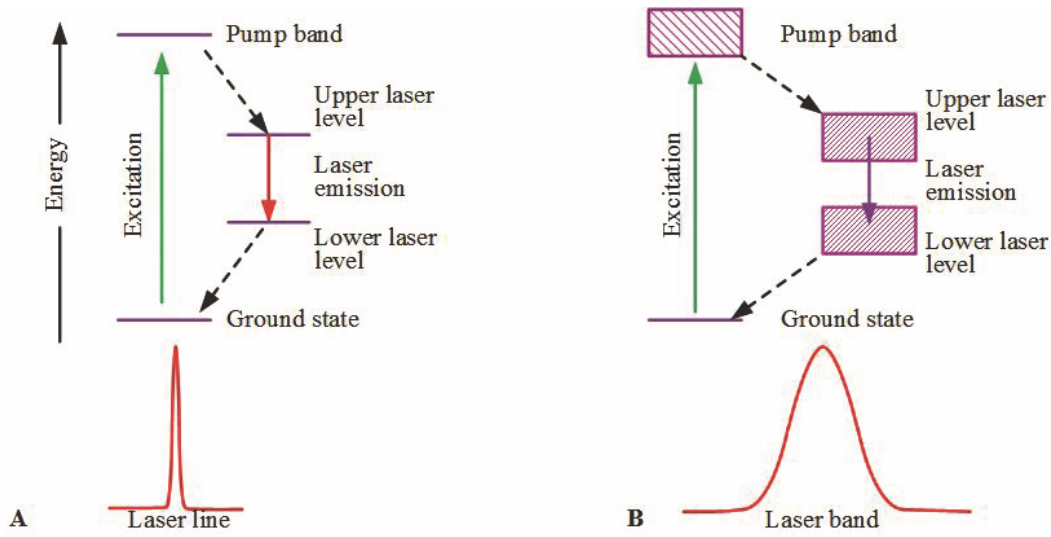

Figure 3-3 Laser emission between two isolated states is a narrow line. But when the upper or lower laser level (or both) span a band of closely spaced energy levels, the emission spans a much wider range of wavelengths.

The wavelengths that actually oscillate depend on the laser cavity and the gain curve. This range of wavelengths will be narrowed if the cavity has a highly reflective output mirror, to amplify the light resonating in the cavity. For example, if the gain at the center of the curve in Figure 3-2 is 1, and the gain at a slightly longer wavelength is 0.9, after 10 round trips, the power at the longer wavelength will be $0.9^{10} = 0.35$ of the power at the center wavelength. So in general, a laser in a strongly amplifying cavity will not oscillate across the whole wavelength range where the laser medium has gain.

So far, we have assumed that the laser cavity reflects all wavelengths equally. However, a laser cavity also can be designed to reflect some wavelengths more strongly than others. One way to do that is by inserting a prism or diffraction grating that refracts or scatters light of different colors at different angles, as shown in Figure 3-4. At the angle shown, the green light is diffracted back into the laser medium to be amplified and produce a green beam, but the red and blue wavelengths are diffracted to the sides and lost. This allows laser output to be tuned across the gain band of the laser medium.

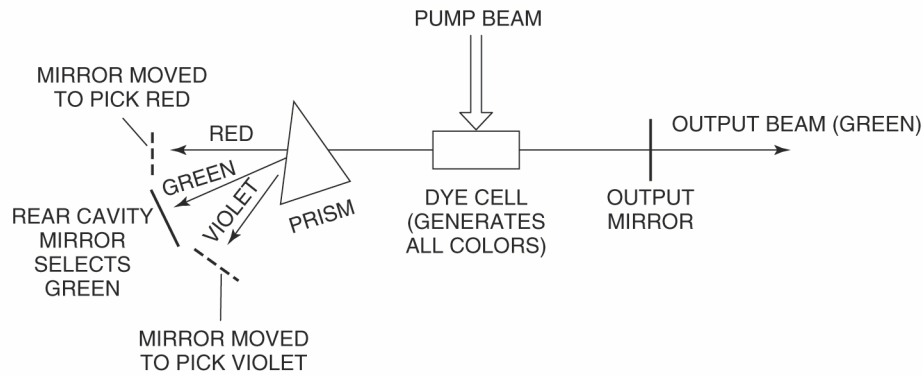

Figure 3-4 Tunable dye-laser cavity using a stationary prism. The prism refracts light of different wavelengths at different angles, and a moving mirror selects which wavelength oscillates in the laser cavity. Moving the mirror would tune the cavity to emit other wavelengths.

Laser cavity optics also can be changed in other ways. Some laser media can emit on a number of different transitions that are separate from one another; examples include the argon-ion, krypton-ion and helium-neon lasers. Argon and krypton lasers can be tuned between different lines by adjusting cavity optics, but helium–neon lasers usually are built with fixed optics that reflect the desired wavelengths—typically the red or green lines described below.

Wavelength Shifting

The output of lasers can also be shifted in wavelength. Sometimes, they are shifted within the laser cavity itself, and sometimes they are shifted in an optically separate unit packaged together with the laser.

One example is harmonic generation, a nonlinear process that multiplies the frequency of the laser light. Like other nonlinear processes, it works best at high incident powers because the conversion efficiency is proportional to the square of the power density. The second harmonic is easiest to generate. The most common example of second harmonic generation is the green laser pointer, which doubles the frequency of a near-infrared laser from the fundamental wavelength of 1064 nm to 532 nm in the green range. It's packaged to look like a green laser, but inside, it's a diode-pumped infrared laser plus a second harmonic generator, as shown in Figure 3-5. However, some lasers include harmonic generation within the laser cavity.

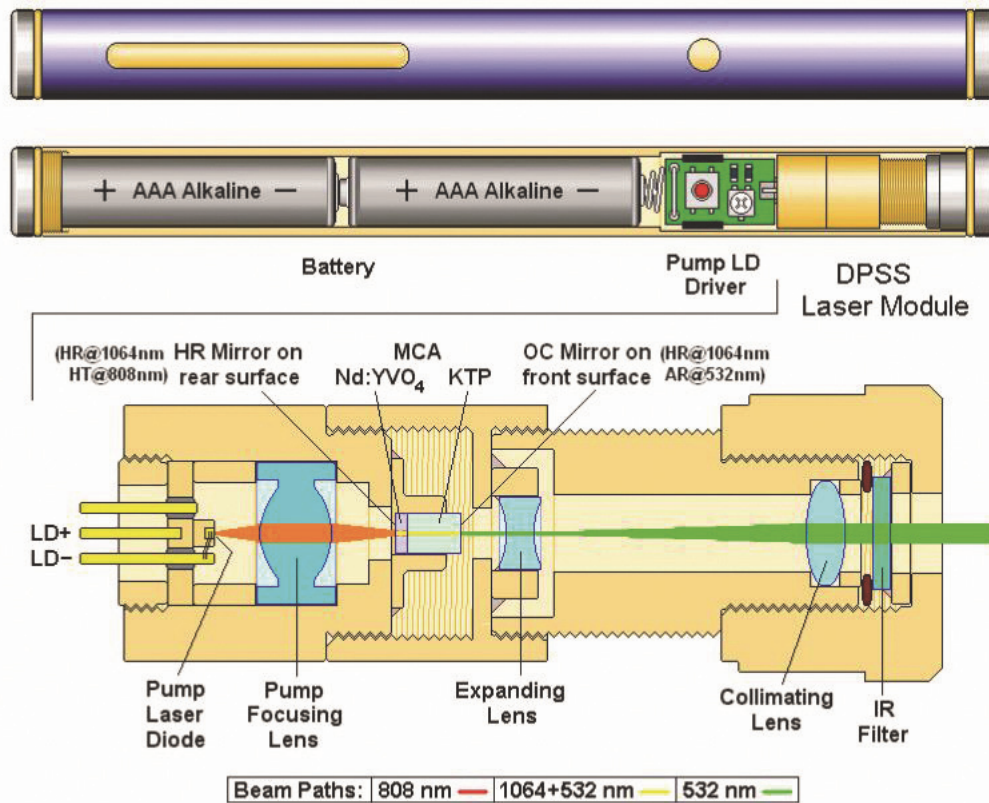

Typical Green DPSS Laser Pointer Using MCA

Figure 3-5 This green laser pointer includes two batteries, an electronic driver, an 808 nm pump diode, a neodymium laser emitting at 1064 nm, and a harmonic generator that doubles the frequency to produce green light

Additional harmonic generation is possible. The first harmonic can be combined with the second harmonic in a suitable nonlinear material to produce the third harmonic. The second harmonic can be doubled to produce the fourth harmonic, and even higher harmonics can be produced. In general, the higher the harmonic, the more energy is lost in producing it, but the process can be made quite efficient.

Another approach to wavelength shifting is optical pumping, in which light from one laser excites another laser to emit light. To produce desired wavelengths or generate higher-quality beams, it is common to start with diode lasers, which convert electric power into light very efficiently, but only at a limited range of wavelengths and with poor beam quality. For example, diode pumping a solid state neodymium laser produces a high-quality beam at 1064 nm that can easily be frequency doubled into green light. The three-step process sounds cumbersome, but is the most efficient way to generate a high-quality green beam.

Fluorescence is closely related to optical pumping, but instead of exciting laser emission, it makes objects glow in incoherent light. You can see the process if you shine a 405 nm violet laser pointer onto many orange or yellow plastics. Most fluoresce brightly and so look much brighter than the laser beam. That is not because they emit more light than was in the laser

beam; it's because the human eye is quite insensitive to 405 nm light, so the violet laser spot looks deceptively faint. Note that both fluorescence and optical pumping initially generate photons with lower energy than the pump photons.

Laser Packaging

Packaging is important to ensure that commercial lasers are safe. You should already have studied laser safety regulations, which include warning labels and safety equipment such as emission indicators and key interlocks.

Laser packaging also is important for making lasers easy and effective to use. Without packaging, a red semiconductor diode laser is just a tiny chip, like a grain of sand. But when that laser chip is packaged with batteries, a drive circuit, a switch, and beam-focusing optics, it becomes a laser pointer. With other optics and accessories such as a beam scanner, the laser can become a surveying tool or a supermarket checkout scanner.

Commercial lasers of the same type may be used in widely divergent applications that require very different packaging. For example, argon–fluoride excimer lasers emitting pulses of 193 nm ultraviolet light are used for both refractive surgery and fabrication of semiconductor chips, but they are packaged in very different ways for those two applications, as shown in Figure 3-6.

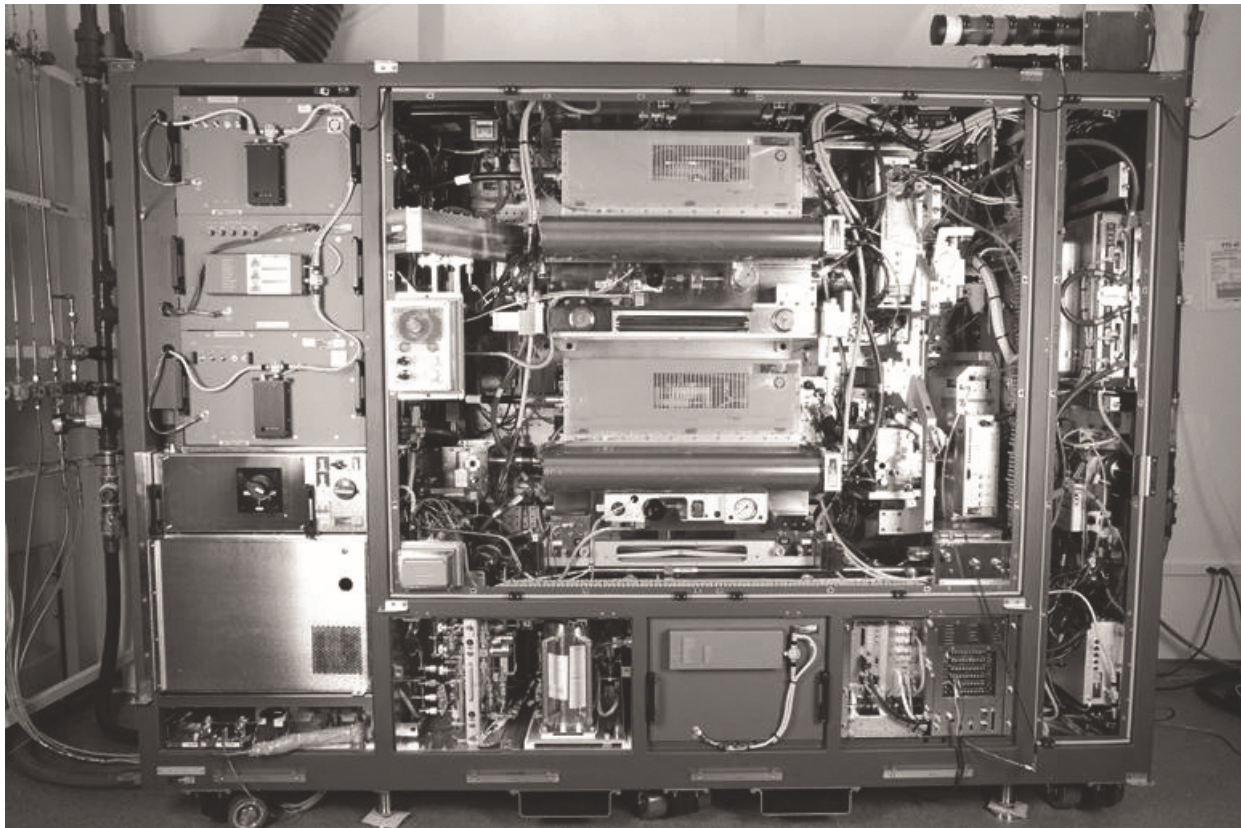

Figure 3-6: A) *An argon–fluoride excimer laser being used in LASIK surgery at the National Naval Medical Center Bethesda (government photo, not subject to copyright).* B) *A semiconductor photolithography system based on an argon–fluoride laser (courtesy ASML).*

Let's now turn our attention to specific types of lasers and discuss their operating features.

Laser Types

In this section, we describe several different types of lasers. Our objective is to review these lasers and provide a broad overview of their basic operating principles. Other modules in this course provide more in-depth treatments of several of the laser types presented in this section. Table 3-1 provides a reference to these modules.

Table 3-1. A Reference to the Laser Modules in the Course

Module	Laser Type
2-4	CO ₂
2-5	Fiber
2-6	Diode
2-7	Argon-Ion
2-8	Nd:YAG
2-9	Excimer

Gas Lasers

Gas lasers can take many forms, from small tubes that emit a milliwatt of visible light to massive machines that emit kilowatts for industrial machining. Although solid state and semiconductor lasers have replaced gas lasers for many applications, gas lasers remain widely used and commercially important, and they make a good starting point for discussing the wide assortment of lasers that are currently in use.

The lasing medium in all gas lasers is in the gas phase, so light-emitting atoms or molecules are in continual motion, contained within a tube and (generally) isolated from the air. Normally, an electrical discharge excites the gas, with energy-transfer details depending on the gas, but a few gas lasers are optically pumped or excited by chemical reactions. Laser emission has been demonstrated on thousands of wavelengths in gas lasers in the laboratory; this module focuses on the gas lasers that are in greatest use in industry and research in the United States.

General Description

Low-power gas lasers are contained in sealed tubes. Gas lasers operating at the milliwatt level do not require active cooling, but as power increases, active cooling becomes important. Moderate-power lasers are cooled with forced air, and higher-power lasers are cooled by flowing water. At very high powers, the laser gas may flow through the tube and be exhausted into the air or pumped into a sealed tank to remove excess heat. Most power used to excite gas lasers is turned into heat, so cooling is very important.

Gases have high electrical resistance until electrical breakdown occurs and frees electrons to carry current through the gas. This current is typically used in a gas laser as the pumping source. To create electrical breakdown in a high-resistance gas, a high voltage is needed. However, once electrical breakdown occurs in a gas laser, the voltage can be reduced and stay reduced for normal operation. High voltages in gas lasers represent a safety hazard that must be addressed to prevent injury.

Gas lasers operate on various types of transitions. Atomic gases such as neon and argon emit only when electrons drop from a high energy level to a lower energy level. Electronic transitions

have wavelengths in the ultraviolet, visible, and near infrared ranges, as shown on Figure 3-7. Gas molecules also can emit on electronic transitions in the same bands, or on lower-energy, longer-wavelength transitions between vibrational and rotational states. The physical structure of the molecule provides the mechanism for these transitions, which, like electronic transitions, result from stimulated emission. Vibrational transitions range from the near infrared range out to about 20 μm and often occur simultaneously with a rotational transition, as you will see with the carbon-dioxide laser. Rotational transitions have even lower energy and correspond to wavelengths in the far infrared range, from several tens of micrometers to millimeter waves, in a region also called the terahertz band.

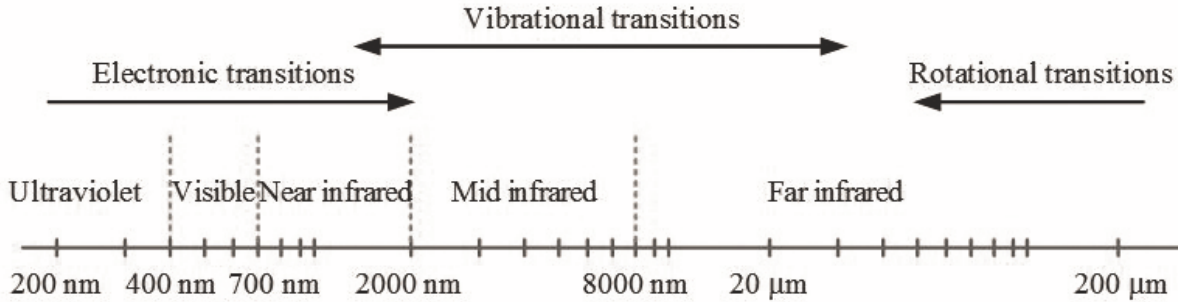

Figure 3-7 Types of gas-laser transitions and the bands in which they occur

Helium–Neon Lasers

The helium–neon laser gets its name from the two gases that are blended to make it work. The more abundant helium atoms collect energy from collisions with electrons in the drive current and then transfer that energy to the neon atoms, which can generate laser light through several transitions, as shown in Figure 3-8. Normally, only one transition lases at a time in any individual tube.

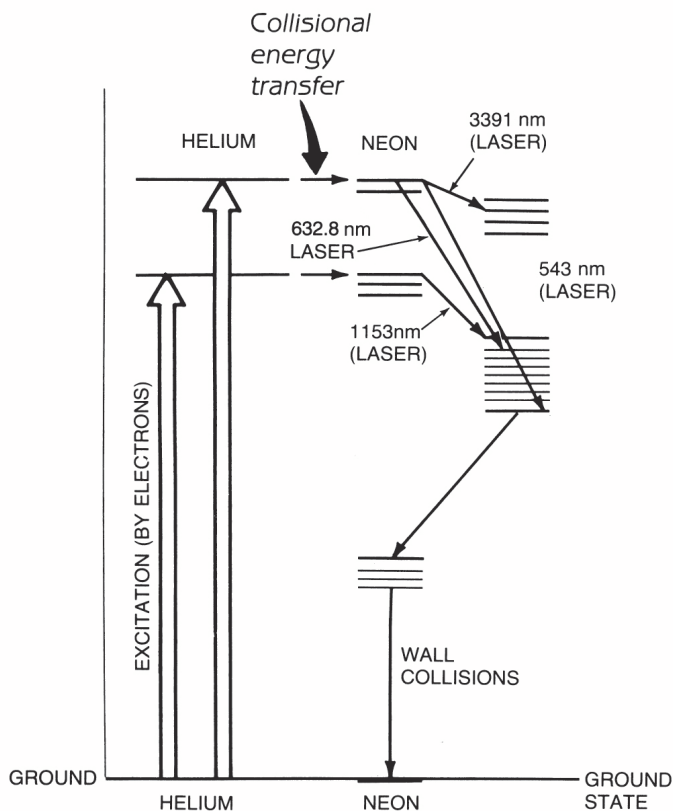

Figure 3-8 Key energy levels and transitions in helium–neon lasers. Electrons collide with helium atoms and excite them; then the helium atoms collide with neon and excite the neon. Transitions go between different pairs of energy levels. These are the four best-known laser lines for the helium–neon laser.

Table 3-2 lists some laser lines that can be generated from a helium neon laser. Which line dominates depend on the choice of resonator mirrors and the relative gain on the laser lines.

Table 3-2. Helium–Neon Laser Wavelengths

Wavelength	Color
543.5 nm	Green
594.1 nm	Yellow
604.0 nm	Orange
611.9 nm	Orange
632.8 nm	Red (primary visible line)
1153 nm	Infrared
1523 nm	Infrared
3390 nm	Infrared

Although semiconductor diode lasers have replaced the red HeNe in most of its original applications, gas lasers are still used when better beam quality, narrower line width, and longer coherence lengths are needed.

A typical helium–neon laser contains five parts of helium to one part of neon, sealed inside a laser tube like the one shown in Figure 3-9. As the figure shows the cavity mirrors are outside the main tube, which is sealed on the output end with a mirror at Brewster’s angle to polarize the beam and reduce losses.

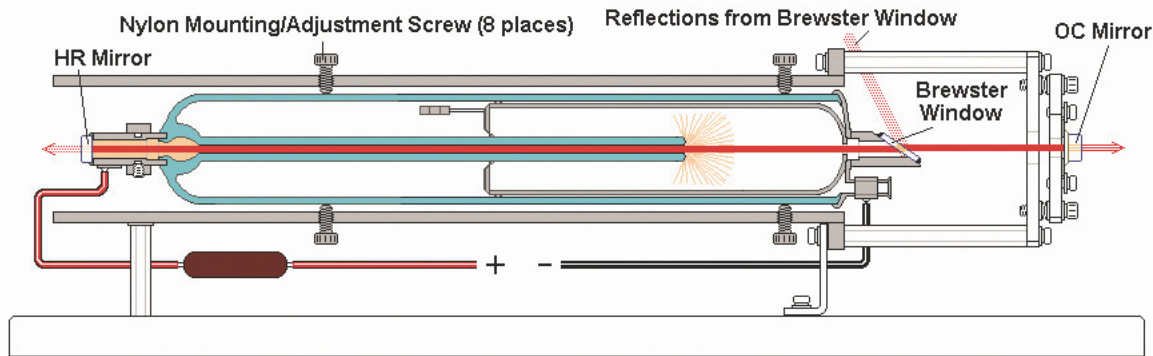

Melles Griot Style One-Brewster HeNe Laser Tube Mounted in Test Fixture

Figure 3-9 Structure of a HeNe laser. Red light passes through a bore in the center of the tube. HR is a high-reflectivity back mirror. OC is an output coupling mirror, which typically transmits a small fraction of the light circulating in the cavity.

The red HeNe line is the strongest in the visible range, emitting up to 20 mW, and red models are the most common. The other visible lines are weaker but can be made to emit up to a couple of milliwatts with suitable optics and are available commercially. HeNe lasers emitting at 1523 and 3390 nm in the infrared range also are available.

A pair of electrodes in the helium–neon laser at opposite ends of a tube 10 to 30 cm long applies about 10,000 V across the gas, ionizing atoms to conduct current. Once the discharge is established, the power supply drops to a couple thousand volts, and the current drops to a few milliamperes, sufficient to sustain continuous laser operation. Because it takes time to stabilize the discharge, helium–neon lasers are normally operated continuously. The narrow inner tube in the center of the tube improves excitation efficiency. Other parts of the tube serve as a gas reservoir, with pressure a few tenths of 1% of an atmosphere.

Helium–neon lasers have low gain and are inefficient. As a result of their low gain, helium–neon lasers require highly reflective cavity mirrors with low losses and an output mirror that transmits only a small fraction of the laser light. Low efficiency results from a requirement for high pumping energy and low laser transition energy. All the helium–neon transitions are far above the ground state and require 19.5 to 21 eV of excitation energy, but the laser transitions release only 1 to 2 eV. The system has other losses, so only about 0.1 percent of the electrical energy used by a typical helium-neon laser emerges in the laser beam.

Most helium-neon lasers emit TEM₀₀ beams about a millimeter in diameter and a milliradian in divergence. Typically, Doppler-broadened line width for single-transverse-mode operation on the red line is about 1.4 GHz, giving a coherence length around 25 cm. Special optics within the helium–neon laser can limit oscillation to a single longitudinal mode with 1 MHz bandwidth and coherence length of 200 to 300 m.

Helium–neon lasers typically are packaged with the power supply and controls in a box separate from a cylindrical or rectangular head that is 15 to 75 cm long. Standard helium–neon lasers emit only one of the wavelengths listed in Table 3-2, but tunable models are available that can be switched between the five visible lines.

Argon–Ion and Krypton–Ion Lasers

Argon and krypton are the most important members of a family of lasers based on ionized rare gases, also known as noble gases—atoms that have a full outer shell of electrons and so do not normally form stable molecules. An electric discharge ionizes the gas, which lases on a transition of the ion. (Note that the helium–neon laser emits on transitions of neutral neon.)

Argon–ion and krypton–ion lasers offer more continuous wave power and shorter wavelengths than the red helium neon laser. The strong green and blue lines of argon and the red line of krypton are widely used for applications from fluorescence spectroscopy and medicine to laser light shows with multicolored beams. Argon output reaches 25 W, and krypton reaches 10 W. However, these lasers are even less efficient than HeNe lasers. The most powerful large-frame ion lasers need 440 V of power, as well as water cooling. Frequency doubled solid state lasers are far more efficient and have replaced argon and krypton for many applications. The strongest argon laser lines are at 488.0 nm in the blue–green range and at 514.5 nm in the green range. Figure 3-10 shows the argon-ion laser transitions. Additionally, argon lasers can be mode locked to generate a train of short pulses.

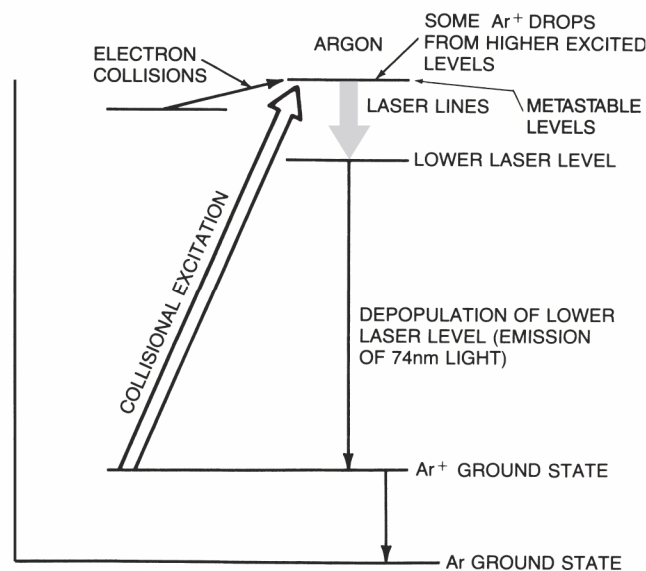

Figure 3-10 Argon-ion laser lines

Like helium–neon lasers, argon and krypton lasers have modest gain, so they require highly reflective cavity optics, and the output mirror only transmits a small fraction of the circulating power in the laser beam. Output powers range from milliwatts to about 25 W, depending on both the laser line chosen and the size of the laser. Since both argon and krypton lasers have low wall-plug efficiency—generally 0.1% or less—producing watts of output requires kilowatts of electrical power and typically requires water cooling.

More details on how argon–ion lasers operate can be found in Module 2-7 of this course.

Helium–Cadmium Lasers

The lasing medium in a helium-cadmium laser consists of vaporized cadmium, which has the physical properties of a gas. These lasers can emit a continuous beam of laser light at powers between several milliwatts to about 200 mW. The primary helium–cadmium transition lines are 441.6 nm in the blue range and 325 nm in the ultraviolet range, which have applications in fluorescence measurements and the mastering of optical disks.

The first step in operating a helium–cadmium laser is vaporizing enough cadmium to build up several millitorr of vapor in the laser tube, which typically takes 10 to 30 min. The tube also contains about one torr of helium. After a brief high-voltage pulse ionizes the cadmium and some helium, the power supply provides a steady 1500 V. As in He–Ne lasers, electrons excite helium atoms, and the helium transfers energy to cadmium ions, which quickly drop to the metastable upper levels of either the ultraviolet or the blue laser line. After dropping to the lower laser level, the cadmium ions drop to the ion ground state, helping sustain a population inversion.

The helium–cadmium laser converts less input power into laser light than the helium-neon laser, so it has more waste heat and often requires forced-air cooling. Like helium–neon and ion lasers, the gain is low, so the output mirror couples only 1% to 3% of the circulating power into the output beam. At low powers, helium–cadmium emits a TEM₀₀ in a single transverse mode, but some higher-power models emit multimode.

Cadmium vapor complicates laser operation because the positive ions migrate toward the negative electrode, where they can collect and deplete the cadmium reserve, trap helium atoms, and deposit cadmium on optical surfaces. Cold traps can protect the optics, and cadmium reserves can replenish the metal, but laser-tube lifetimes are limited to several thousand hours.

Carbon Dioxide Lasers

Carbon dioxide lasers are the best-selling gas lasers in dollar terms. That success comes in large part from their high power and efficiency, which are unmatched by any other commercial gas laser. CO₂ lasers also are versatile enough to find many other applications, although materials working (welding, marking, cutting, drilling, etc.) remains by far the largest market. Most generate continuous beams from under a watt to well over 10 kW, but CO₂ lasers also can be pulsed. Their output is in a band between 9 and 11 μm.

CO₂ is a molecular laser. Molecular lasers emit light when the molecule drops from a high-energy vibrational state to a lower-energy state. These transitions are not the typical electronic transitions that most lasers use to produce their output light. This difference occurs because the gas that lases in these lasers is not composed of a single element, but instead is a molecule with a specific structure. The top of Figure 3-11 shows how the structure of the CO₂ molecule allows its atoms to move in three primary vibrational states, and the bottom shows the transitions in the laser. An electric discharge in the laser excites nitrogen molecules mixed with the CO₂, which transfer their energy to CO₂ molecules, raising them to the highest-energy state, the asymmetric stretching vibrational mode ν_3 . From there, the atoms can drop to either the bending vibrational mode ν_2 or the symmetrical stretching vibrational mode ν_1 , with nominal wavelengths of 10.4 or 9.4 μm, respectively. These transitions occur in exactly the same manner as electronic transitions: through stimulated emission caused by the laser light photons in the laser cavity. After the CO₂ molecules reach both lower energy levels, they collide with helium,

which helps them release energy to depopulate the lower levels and sustain a population inversion.

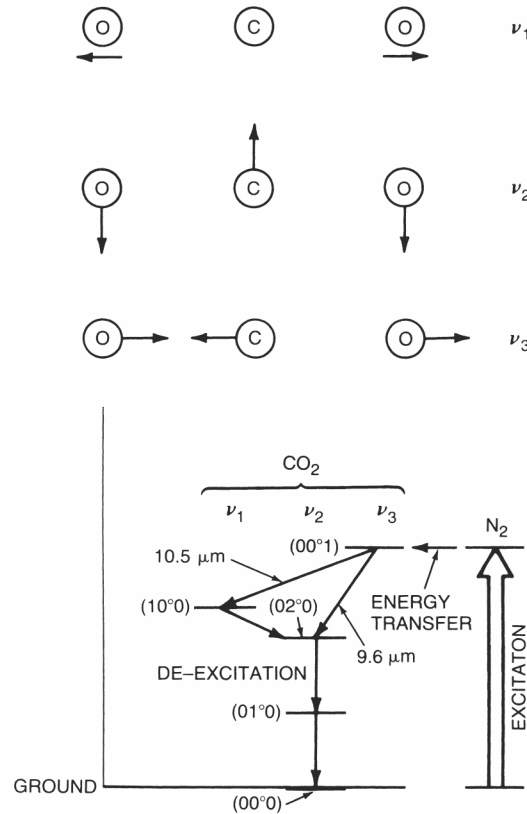

Figure 3-11 CO_2 molecular vibration modes (top) and laser transitions between them (bottom). The numbers are conventional codes for the particular vibration modes.

CO_2 lasers are by far the most efficient gas lasers: up to 20% of their discharge energy is converted into light. The discharge design depends on the power level. For laser outputs less than 100 W, the gas is sealed inside the tube and excited through a pair of electrodes or by a radio-frequency discharge. Higher powers require flowing fresh gas through the tube, either in a once-through arrangement or by mixing fresh gas with recycled gas. At powers up to several hundred watts, the gas can be flowed straight through the tube, in line with the discharge and resonator. For higher powers, the discharge and the gas flow are across rather than along the length of the laser cavity.

Rapid expansion of hot, high-pressure CO_2 through nozzles into a near vacuum can produce a population inversion by cooling most of the molecules while allowing some to retain high energy. Flowing the expanding gas transversely through a laser cavity can generate a very powerful beam. Such lasers are called *gas-dynamic*. In military research, these lasers produced powers up to 100 kW, but they did not prove practical for either weapons or industrial applications.

CO_2 lasers operate at much longer wavelengths than most other lasers, so they require special optics made from materials that transmit or reflect wavelengths of 9 to 11 μm . Refractive materials include zinc sulfide and selenide, germanium, silver chloride, and potassium chloride.

More details on how CO₂ lasers operate can be found in Module 2-4 of this course.

Rare-Gas–Halide/Excimer Lasers

Another molecular gas laser plays crucial roles in both semiconductor manufacture and eye surgery: the rare-gas–halide or excimer laser, which emits powerful pulses in the ultraviolet range at wavelengths listed in Table 3-3. The light emitters in these lasers are unusual short-lived molecules composed of one atom of a rare gas and one of a halogen. They exist only in an excited state; when they drop to the ground state, they lose the energy that held them together, and they fall apart. Such molecules are called “excimers.”

Table 3-3. Major Excimer and Rare-Gas–Halide Lasers and Their Wavelengths

(The 157 nm molecular-fluorine laser is sometimes called an “excimer” laser, but F₂ is not a rare-gas halide.)

Type	Wavelength
F ₂	157 nm
ArF	193 nm
KrCl	222 nm
KrF	249 nm
XeCl	308 nm
XeF	350 nm

The unusual physics that creates excimers gives them properties particularly useful in lasers. They have very high gain and emit at ultraviolet wavelengths. Ultraviolet photons make up the output of this laser and also stimulate within the cavity of the laser the transition of the excimers from their metastable states to ground states. These photons carry enough energy to break up organic molecules in living tissue and to expose the photoresists used to fabricate integrated circuits on semiconductor chips.

Rare-gas halides exist only briefly after a short, powerful current pulse is fired into a mixture containing about 90% buffer gas, a rare gas (argon, krypton, or xenon), and a compound containing the halogen that reacts to form the excimer. The electric pulse frees the halogen from the molecule that contained it, and gives it enough energy to react with the rare gas to form a rare-gas halide such as argon fluoride (ArF). The excimer is formed in an electrically excited state. After around 10 ns, the excimer drops to a lower-energy state in which the two atoms are not chemically bound. As it drops, it releases an ultraviolet photon, which allows the two atoms to split. Because the lower laser level is unbound, the population inversion exists for the same time as the discharge pulse that was fired into the original mixture of gases. The gas reconstitutes itself before the drive electronics are ready to fire another pulse.

The five rare-gas–halide lasers listed in Table 3-3 operate similarly but differ in output wavelength, operating power, and wall-plug efficiency. All have high gain, and their laser cavities contain a reflective rear mirror and output windows that reflect only a small percentage of the generated light back into the cavity. The discharge that powers the laser is transverse to the cavity. Average power can reach several hundred watts, and pulse energies can reach a joule. Wall-plug efficiency can reach 2%, which is good for an ultraviolet laser.

As high-gain pulsed lasers, rare-gas halides have larger beam diameter and divergence than lower-power continuous-wave visible lasers. The halogens and their compounds used in excimer lasers are both corrosive and toxic and so require special handling. All material exposed to the laser gas must resist halogens, and over time, the reactive components in the laser gas get depleted, so the laser must be refilled with fresh gas. Operating lifetimes differ among the various compounds used.

The largest market for excimer lasers is for writing patterns on semiconductor integrated circuits. High resolution and high throughput are crucial for chip manufacture, and the laser of choice has long been argon fluoride emitting at 193 nm. Thanks to some ingenious tricks, the 193 nm ArF laser can now resolve features only a small fraction of its wavelength, and developers are pushing for even higher resolution. So far, the 157 nm molecular-fluorine laser has proved impractical because the short-wavelength photons damage optical components.

The excimer laser market most visible to the public at large is for LASIK refractive surgery. Focusing 193 nm ArF pulses onto the cornea can cause ablation patterns that reshape its surface to improve the patient's vision. Other lasers have been tested, but ArF has proved the best choice. Other excimer lasers are made for general-purpose research or for specific applications. For example, one company offers a 248 nm krypton-fluoride laser designed specifically for writing Bragg gratings in optical fibers; it fires 140 mJ, 20 ns pulses up to 100 times per second.

Nitrogen Lasers

Nitrogen lasers are a poor person's substitute for an excimer laser. Firing short electric pulses into molecular nitrogen (N_2) at pressures from about 0.03 to one atmosphere excites a hybrid electronic-vibrational transition to emit 337 nm ultraviolet pulses. The transition has high gain and can lase without a rear-cavity mirror, although adding one doubles pulse power. However, the nitrogen atoms remain bound in the lower laser state, so they accumulate, ending the population inversion, stopping the laser pulse after a few nanoseconds, and limiting pulse energy to about 10 mJ.

Even with the limits on pulse energy and efficiency, nitrogen lasers do have some advantages over excimers. They are safer and easier to use because they contain harmless nitrogen rather than hazardous halogens. Nitrogen lasers also are smaller and less expensive, and a suitable power supply and optics can produce nitrogen laser emission from the nitrogen in air at standard temperature and pressure.

High-Power Chemical Lasers

An alternative to electric power for producing a population inversion is using a chemical reaction to create an excited species. The first chemical lasers were made in the 1960s and were studied for possible use as high-energy laser weapons. Two types emerged as candidates.

Chemical Hydrogen-Fluoride Lasers

The reaction of hydrogen and fluorine produces hydrogen-fluoride molecules excited to the upper levels of a series of vibrational transitions emitting at 2.6 to 3.0 μm . Like the many lines in the 10 μm CO_2 laser band, the HF transitions are produced by transitions in both vibrational and rotational energy levels.

The gases are mixed in a fast-flowing system rather like a rocket engine, with the hydrogen source and the fluorine source kept separate until they are fed through nozzles into a mixing region, where they react to form excited HF molecules. These molecules then pass through a

region where a pair of mirrors on opposite sides forms a laser cavity, as shown in Figure 3-12. The HF exhaust is pumped from the laser and collected in tanks because it is toxic and corrosive.

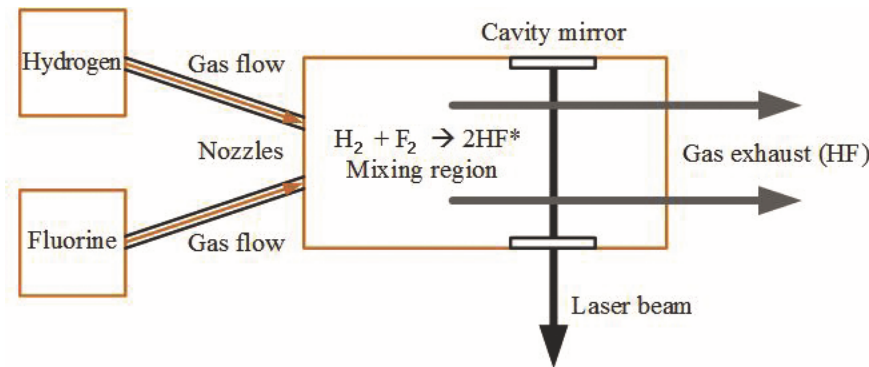

Figure 3-12 Schematic of a chemical laser

The 2.6 to 3.0 μm emission from HF molecules containing the common hydrogen-1 isotope is absorbed by air, so laser-weapon developers substituted the rare isotope deuterium (hydrogen-2) to make deuterium-fluoride, which emits at 3.6 to 4.0 μm , where the atmosphere transmits light better. A ground-based deuterium-fluoride laser called MIRACL (for Mid-InfraRed Advanced Chemical Laser) demonstrated megawatt power, and a smaller test bed called THEL (the Tactical High Energy Laser) shot down rockets and artillery shells but neither proved practical.

Chemical Oxygen–Iodine Lasers

The chemical oxygen–iodine laser or COIL has also approached megawatt powers on a 1.315 μm transition of atomic iodine. Its operation starts with adding chlorine gas to a solution of hydrogen peroxide and potassium hydroxide, which releases oxygen molecules in an excited state that reacts with molecular iodine, freeing excited iodine atoms.

The U.S. Air Force’s Airborne Laser demonstration squeezed a high-energy COIL into a military version of a Boeing 747 and successfully shot down missiles in flight. However, the project was discontinued because it could not reach the required power and range.

Solid State Lasers

The term “solid state” has a special meaning in the laser world—it describes not just a solid laser medium, but rather a laser medium that is a particular type of solid. The solid in a solid state laser is a transparent nonconductive material whose atoms can absorb pump light and emit laser light. Because the solids are nonconductive, solid state lasers must be pumped or excited with light.

A simple example is the first laser, made in 1960 by Theodore Maiman. The solid he used was synthetic ruby—a crystal of sapphire (a transparent form of aluminum oxide) containing a small amount of chromium that gave it a pink color. Maiman placed a ruby rod inside a spring-shaped (helical) photographic flashlamp and enclosed it in an aluminum cylinder, as shown in Figure 3-13. The intense flash from the lamp provided the excitation energy that raised the chromium atoms to a metastable upper laser level. The chromium atoms lost their excitation energy, when they dropped from the metastable level to the ground state and, in this process, emitted red photons.

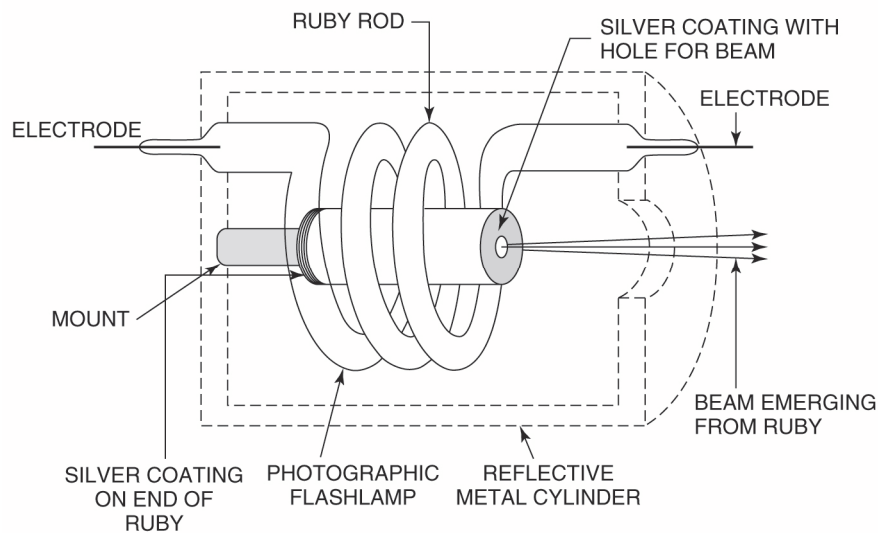

Figure 3-13 *Cutaway drawing of the first ruby laser. The laser rod is the glassy pink cylinder inside the coils of the lamp; the beam it emits to the right is a deeper red. Mirrors are at both ends of the rod.*

Modern solid state lasers work similarly. Light from an external source—now usually a diode laser rather than a flashlamp—passes through the transparent host material (a crystal or glass) to excite atoms, which then emit laser light. The light-emitting atoms essentially replace a few chemically similar atoms in the host material, just as chromium atoms replace a few aluminum atoms in ruby. The light emitters are often called “ions,” because of the bonds they form in the crystal. When the ions absorb or emit light, their electrons undergo transitions to higher or lower energy levels. The transition of these electrons through stimulated emission produces laser light.

Many combinations of light-emitting ions and host materials can work as lasers, but only a few of the best combinations are produced commercially. Host materials fall into three broad categories: single crystals, polycrystalline ceramics, and glasses. Single crystals have the best combination of heat conduction and mechanical strength, but crystal growth is slow and costly, so sizes are limited, and cutting and polishing can be difficult. Polycrystalline ceramics, formed by sintering together many small crystals, are easier to produce in larger sizes, but optical quality and light scattering can be issues. Glasses are the easiest to fabricate and can be made in very large sizes, but they are amorphous and do not conduct heat as well as crystals.

The choice of light-emitting element is crucial. The best for many properties are rare earth elements including neodymium, ytterbium, erbium, holmium, and thulium, which have fundamental frequency output in the near-infrared range. Chromium and titanium also work well in selected hosts. These laser ions are highlighted in Figure 3-14. This module focuses on these materials.

1 H 1.008																	2 He 4.0026														
3 Li 6.94	4 Be 9.0122											5 B 10.81	6 C 12.011	7 N 14.007	8 O 15.999	9 F 18.998	10 Ne 20.18														
11 Na 22.99	12 Mg 24.305											13 Al 26.982	14 Si 28.085	15 P 30.974	16 S 32.06	17 Cl 35.45	18 Ar 39.948														
19 K 39.098	20 Ca 40.078	21 Sc 44.956	22 Ti 47.867	23 V 50.942	24 Cr 51.996	25 Mn 54.938	26 Fe 55.845	27 Co 58.933	28 Ni 58.693	29 Cu 63.546	30 Zn 65.38	31 Ga 69.723	32 Ge 72.63	33 As 74.922	34 Se 78.96	35 Br 79.904	36 Kr 83.798														
37 Rb 85.468	38 Sr 87.62	39 Y 88.906	40 Zr 91.224	41 Nb 92.906	42 Mo 95.96	43 Tc [97.91]	44 Ru 101.07	45 Rh 102.91	46 Pd 106.42	47 Ag 107.87	48 Cd 112.41	49 In 114.82	50 Sn 118.71	51 Sb 121.76	52 Te 127.6	53 I 126.9	54 Xe 131.29														
55 Cs 132.91	56* Ba 137.33	71 Lu 174.97	72 Hf 178.49	73 Ta 180.95	74 W 183.84	75 Re 186.21	76 Os 190.23	77 Ir 192.22	78 Pt 195.08	79 Au 196.97	80 Hg 200.59	81 Tl 204.38	82 Pb 207.2	83 Bi 208.98	84 Po [208.98]	85 At [209.99]	86 Rn [222.02]														
87 Fr [223.02]	88** Ra [226.03]	103 Lr [262.11]	104 Rf [265.12]	105 Db [268.13]	106 Sg [271.13]	107 Bh [270]	108 Hs [277.15]	109 Mt [276.15]	110 Ds [281.16]	111 Rg [280.16]	112 Cn [285.17]	113 Uut [284.18]	114 Fl [289.19]	115 Uup [288.19]	116 Lv [293]	117 Uus [294]	118 Uuo [294]														
*Lanthanoids		* <table border="1"> <tbody> <tr> <td>57 La 138.91</td> <td>58 Ce 140.12</td> <td>59 Pr 140.91</td> <td>60 Nd 144.24</td> <td>61 Pm [144.91]</td> <td>62 Sm 150.36</td> <td>63 Eu 151.96</td> <td>64 Gd 157.25</td> <td>65 Tb 158.93</td> <td>66 Dy 162.5</td> <td>67 Ho 164.93</td> <td>68 Er 167.26</td> <td>69 Tm 168.93</td> <td>70 Yb 173.05</td> </tr> </tbody> </table>																57 La 138.91	58 Ce 140.12	59 Pr 140.91	60 Nd 144.24	61 Pm [144.91]	62 Sm 150.36	63 Eu 151.96	64 Gd 157.25	65 Tb 158.93	66 Dy 162.5	67 Ho 164.93	68 Er 167.26	69 Tm 168.93	70 Yb 173.05
57 La 138.91	58 Ce 140.12	59 Pr 140.91	60 Nd 144.24	61 Pm [144.91]	62 Sm 150.36	63 Eu 151.96	64 Gd 157.25	65 Tb 158.93	66 Dy 162.5	67 Ho 164.93	68 Er 167.26	69 Tm 168.93	70 Yb 173.05																		
**Actinoids		** <table border="1"> <tbody> <tr> <td>89 Ac [227.03]</td> <td>90 Th 232.04</td> <td>91 Pa 231.04</td> <td>92 U 238.03</td> <td>93 Np [237.05]</td> <td>94 Pu [244.06]</td> <td>95 Am [243.06]</td> <td>96 Cm [247.07]</td> <td>97 Bk [247.07]</td> <td>98 Cf [251.08]</td> <td>99 Es [252.08]</td> <td>100 Fm [257.10]</td> <td>101 Md [258.10]</td> <td>102 No [259.10]</td> </tr> </tbody> </table>																89 Ac [227.03]	90 Th 232.04	91 Pa 231.04	92 U 238.03	93 Np [237.05]	94 Pu [244.06]	95 Am [243.06]	96 Cm [247.07]	97 Bk [247.07]	98 Cf [251.08]	99 Es [252.08]	100 Fm [257.10]	101 Md [258.10]	102 No [259.10]
89 Ac [227.03]	90 Th 232.04	91 Pa 231.04	92 U 238.03	93 Np [237.05]	94 Pu [244.06]	95 Am [243.06]	96 Cm [247.07]	97 Bk [247.07]	98 Cf [251.08]	99 Es [252.08]	100 Fm [257.10]	101 Md [258.10]	102 No [259.10]																		

Figure 3-14 Highlighted elements are the most important for solid state lasers. Note that most are rare earth elements with similar electron configurations.

The choice of pump source is also crucial. It must emit photons that match the absorption bands of the light-emitting elements and must be bright enough to produce a population inversion. Flashlamps do this, but they are not very efficient because they emit across the whole spectrum and in all directions. Monochromatic light matched to the light emitter is much more efficient, but most lasers don't make good pump sources because they are not efficient. The exception is the semiconductor diode laser, which, as you will see later, can convert a large fraction of the input electrical power into light. Semiconductor diode lasers are now widely used to pump solid state lasers.

Solid State Laser Geometry

Selecting the shape of a solid state laser material requires weighing tradeoffs. A long, thin, pencil-like rod offers a good-quality beam and can be pumped from the side with a linear flashlamp, as shown in Figure 3-15. The lamp and rod are aligned parallel to each other inside a reflective elliptical cylinder, with the rod and flashlamp at the two foci of the ellipse so that the pump light is focused onto the sides of the rod. Larger laser rods can generate more pulse energy, but they require larger crystals and take longer to cool between pulses. Glass can be made into larger rods, but is even slower to cool than crystals are, so its higher power comes at the cost of lower repetition rates.

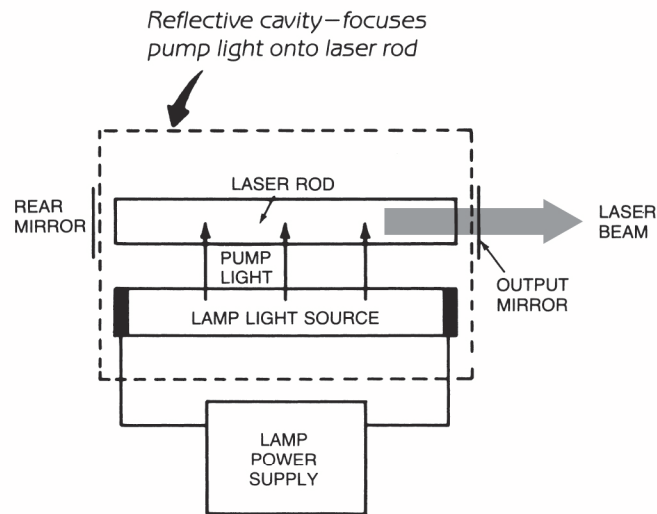

(A) Closely spaced linear lamp and rod (side view).

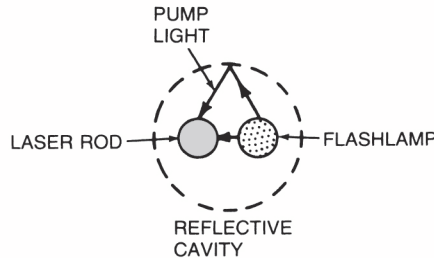

(B) Closely spaced linear lamp and rod (end view).

Figure 3-15 Lamp pumping a solid state laser rod in an elliptical laser cavity

Diode emission is directional, so pump diodes can be placed along the sides of a laser rod. They also can pump from the end of the rod. Matching the pump diode wavelength to the laser absorption band greatly reduces the waste heat deposited in the laser rod, easing cooling requirements and allowing higher-power operation.

Solid state lasers also can take other shapes, which ease the problem of dissipating heat by increasing the ratio of surface area to volume. One example is the slab laser, in which thin slabs of glass or ceramic are pumped either on their face or from the edge. Typically, the laser cavity has a number of reflectors along the edge of the slab, so the laser light follows a zigzag path through the material. Slabs can also serve as amplification stages to boost power from a solid state laser oscillator, with the light making only a single pass through each slab. Slabs can generate quite high powers. Glass slabs amplify pulses for fusion experiments at the National Ignition Facility, and an array of ceramic slabs has generated continuous powers up to 100 kilowatts in military weapon experiments.

Another approach to generating solid state laser powers at tens of kilowatts is diode-pumping a disk of laser material that is less than a millimeter thick and mounted on a heat sink. The diode beams pump the top surface of the thin disk, and a reflective surface mounted on the heat sink reflects light back through the disk and into an external cavity, as shown in Figure 3-16. A single thin disk can generate several kilowatts; several of them can be mounted optically in

series to generate higher powers. Commercial versions go up to 16 kW, and powers of up to 30 kW have been demonstrated in the lab. In practice, both slabs and rods are called “bulk” solid state lasers, in contrast to thin disks, which are small in at least one dimension.

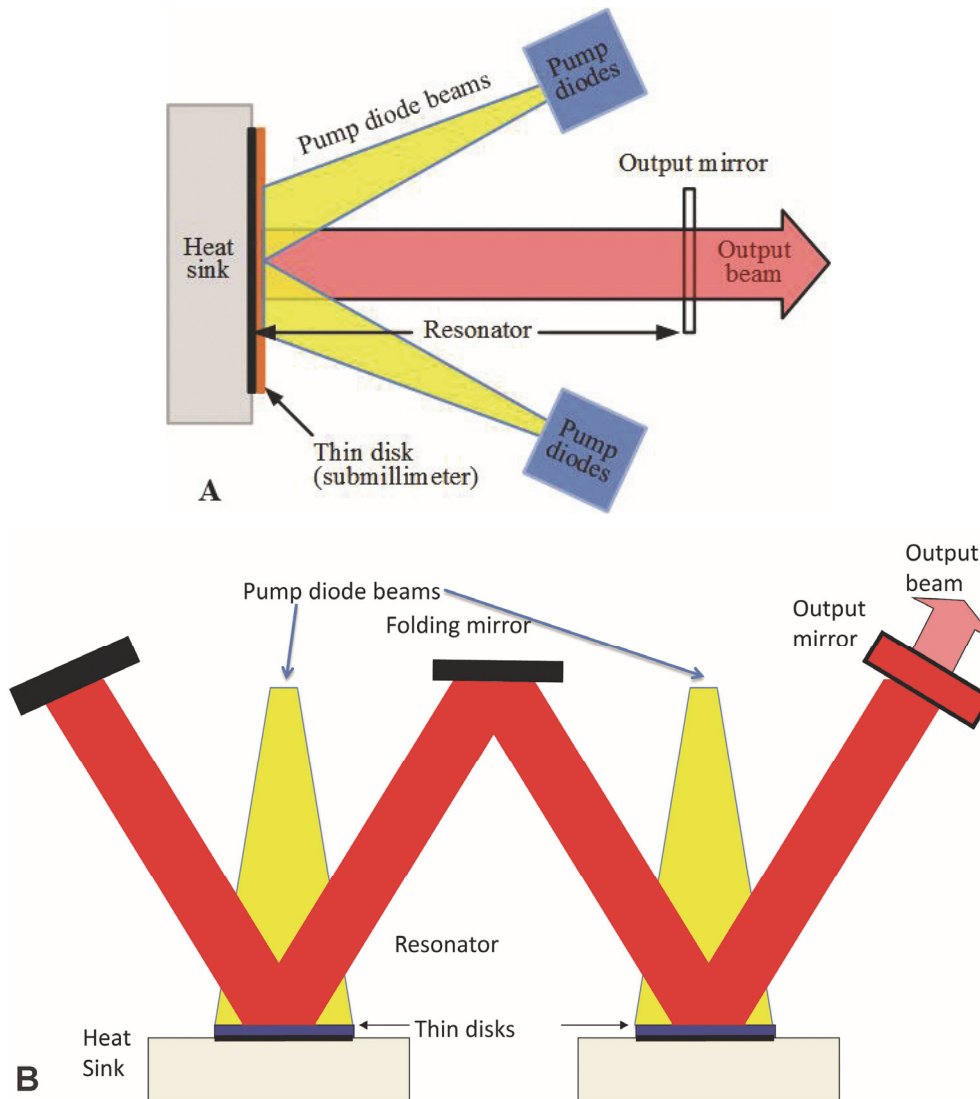

Figure 3-16 Thin disk lasers. A) shows a single thin disk, illuminated from the side with pump diodes. B) shows how a pair of thin disks can be put in series optically in a W-shaped cavity.

A final geometry that has become very successful in the past two decades is stretching the laser rod into a long, thin, optical fiber, with its light-guiding core doped with a light-emitting element, typically ytterbium. The light-guiding structure confines the light well, and additional layers are added to guide the pump light, helping convert as much as 60% of the input pump energy into output laser light. The fiber also has a large surface-to-volume ratio, which aids in cooling. Fiber lasers are so different from other solid state lasers that we discuss them in a separate section of this module.

Neodymium Solid State Lasers

Neodymium is widely used in solid state lasers for applications ranging from tiny rods used in green laser pointers to the giant National Ignition Facility at the Lawrence Livermore National

Laboratory in California. The strongest neodymium line is at 1064 nm in the common host YAG. With harmonic generators, neodymium lasers can generate the 532 nm second harmonic in the green range, and the 355 nm third and 266 nm fourth harmonic in the ultraviolet range.

Highly versatile and widely used, neodymium lasers can be pumped with lamps or with semiconductor lasers and can be operated pulsed or continuous wave to produce good-quality beams. They work well with harmonic generators and Q-switches, and they are efficient enough to be used for pumping other lasers and optical sources such as optical parametric amplifiers and oscillators.

Neodymium is a four-level laser system that has two pump bands, as shown in Figure 3-17. The broader absorption band at the top allows lamp pumping across a broad range of visible wavelengths. The narrow absorption band at 808 nm is used for diode pumping with gallium-aluminum arsenide semiconductor lasers. Neodymium atoms in both pump bands drop quickly to the metastable upper laser level, then emit at 1064 nm when they drop to the lower laser level, which is quickly depopulated. Neodymium has two other laser lines in the near-infrared range, at 946 nm and 1318 nm, but they are rarely used in any research or commercial applications.

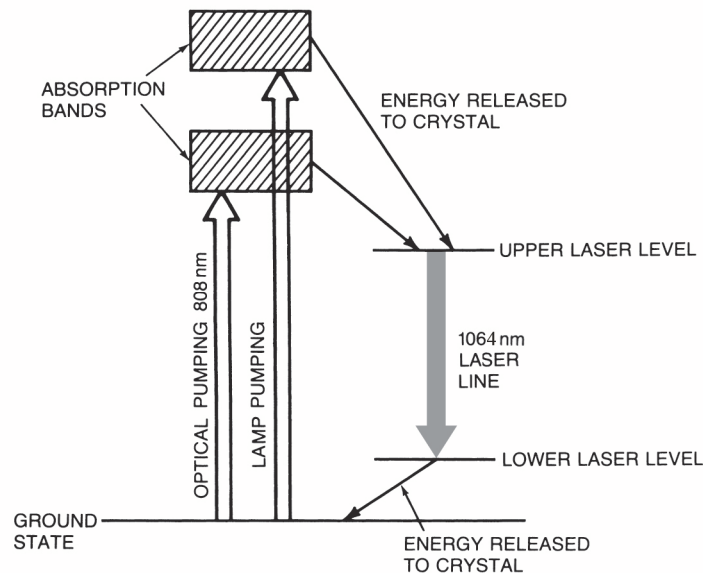

Figure 3-17 Laser energy levels in neodymium, showing pumping both with lamps and with 808 nm diode laser

Interactions between neodymium atoms and the host material determine the exact wavelength of the transition, as shown in Table 3-4. The most important crystalline hosts are compounds containing yttrium, a rare earth element that is chemically very similar to neodymium. About 1% neodymium is added to host crystals, where it replaces yttrium in the crystal lattice.

Table 3-4. Fundamental Wavelengths of Neodymium in Important Hosts

Host	Description	Wavelength (nm)
YLF	Yttrium lithium fluoride, a birefringent crystal	1047 or 1053, depending on polarization
Phosphate glass	Phosphate-based glass	1054
Silicate glass	Silicate-based glass	1062
YAG	Yttrium aluminum garnet $Y_3Al_5O_{12}$	1064
Vanadate	Yttrium vanadate (YVO_4)	1064

YAG is an acronym for yttrium aluminum garnet; garnet is a class of mineral. Garnet's high thermal conductivity and long fluorescence lifetime make Nd:YAG lasers attractive. Typical Nd:YAG rods are pencil sized, 6 to 9 mm in diameter, and up to 10 cm long. Nd:Vanadate is more efficient and less sensitive to temperature. Crystal growth and fabrication processes limit rod size for all crystalline hosts, limiting the energy storage. To overcome this size limit, ceramic forms of crystals such as Nd:YAG are made by melting powder under pressure to produce a polycrystalline material that can be cast into sizes larger than crystals. These polycrystalline materials can be configured into slabs as well as rods. Neodymium-doped glasses also can be cast in large sizes, and they have lower gain, so they can generate higher-energy pulses than crystalline lasers can. However, they cannot conduct heat well, so their repetition rates are slower.

Neodymium lasers use a variety of pumping schemes. Lamp pumping of neodymium lasers is inherently less efficient than diode pumping because lamp emission is poorly matched to the absorption lines. Typically, only 0.1 to 1% of the energy entering the power supply emerges in the laser beam. Lamp pumping now is used mainly to produce high-energy pulses. Diode pumping is much more efficient because diodes are tailored to match the 808 nm absorption peak, so little pump light is wasted, and the diodes convert up to 50% of input power into light. Optical-to-optical conversion efficiency is also high, so wall-plug efficiency can reach 20%. That high efficiency allows diode-pumped neodymium slab lasers to emit continuously at power levels up to 100 kW.

The laser output of neodymium lasers can be altered by intracavity devices. With their large energy-storage capacity, neodymium lasers can be Q-switched; large glass rods produce the highest-energy pulses but have limited repetition rates. The broad linewidth of neodymium-glass lasers makes mode locking possible, but the bandwidth of Nd:YAG and other crystalline hosts is too low. Harmonic generation is so common that frequency doublers are often built into neodymium lasers. The green laser pointer is a particularly good example: the once-exotic technology of harmonic generation is now built into a product that sells for less than \$10. Figure 3-5 shows the construction of a generic laser pointer, which packages complex optics into a tiny package. Table 3-5 lists the harmonic wavelengths offered in commercially packaged neodymium lasers. All but the fifth harmonic are available from many sources.

Table 3-5. Wavelengths Available from Commercially Packaged Neodymium Lasers

Fundamental	1064 nm
Second	532 nm
Third	355 nm
Fourth	266 nm
Fifth	213 nm

Diode pumping and harmonic generation are ways to convert laser beams to different wavelengths or to generate better quality beams. As Figure 3-18 shows, an 808 nm diode can pump a neodymium laser, giving a better quality beam at 1064 nm, and a frequency doubler can convert the near-infrared beam to 532 nm in the green range, where photons have more energy and we can see them. That 532 nm light, in turn, can pump a titanium-sapphire laser (described later in this module), which can be tuned between 660 and 1100 nm if those wavelengths are needed. Doubled neodymium at 532 nm has replaced large and inefficient argon-ion lasers for many applications of green light.

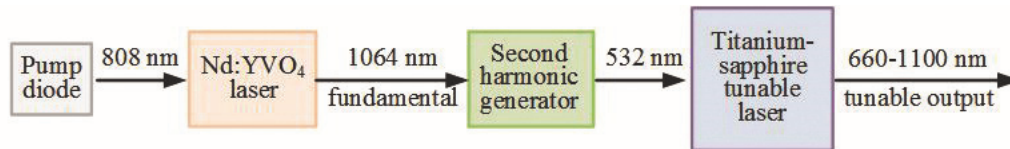

Figure 3-18 Laser wavelength conversion. Light from 808 nm pump diodes excites neodymium, generating laser light at 1064 nm, and harmonic generation shifts the wavelength to 532 nm in the green range. Then the green light pumps a titanium-sapphire laser that is tunable across wide range of wavelengths.

In practice, wavelength conversion generally is not complete, and the pump wavelength needs to be filtered out. Research at the National Institute of Standards and Technology has shown that cheap green laser pointers often lack filters, so their output may include hazardous levels of 808 nm and 1064 nm light, often well above the 5 mW safety limit for laser-pointer output.

More details on how Nd:YAG lasers operate can be found in Module 2-8 of this course.

Other Rare Earth Bulk Lasers (Ytterbium, Erbium, Holmium, and Thulium)

Other rare-earth-doped lasers work much like neodymium, with the rare earth element added to a host material and optically pumped, generally by a diode laser. The four most important rare earth elements for lasers are ytterbium, erbium, holmium, and thulium. Table 3-6 shows important wavelengths. Usually only one of these rare-earth elements is added to a host material, but ytterbium may be added so it can absorb light energy and transfer it to erbium.

Table 3-6 Rare Earth Laser Wavelengths, in Gain in Glass Except Where Noted

Element	Laser range or line	Pumping
Ytterbium	1030-1100 nm	940 nm InGaAs diode lasers
Erbium	1530-1570 nm	980 or 1480 nm diode lasers
Thulium	1900-2050 nm	793 nm GaAlAs diode lasers
Holmium	2130 nm	lamp, diode or other laser
Erbium	2940 nm (not in silica glass)	

Ytterbium lacks absorption bands suitable for lamp pumping, but it does have a narrow absorption line that is at 941 nm in YAG. The development of high-power indium-gallium-arsenide pump diodes made ytterbium lasers practical. With a suitable pump source, ytterbium offers an important advantage over neodymium—ytterbium converts more energy from the pump photon into light than neodymium does, as shown in the energy-level diagram in Figure 3-19. This loss of energy is called the *quantum defect*, and it measures the fraction of energy in the pump photon that does not appear in the laser photon. You can calculate the loss from Equation 3-1:

$$1 - \frac{E_{laser}}{E_{pump}} \quad (3-1)$$

where E_{laser} is the energy of the laser transition and E_{pump} is energy of the pump photon. As you have learned, photon energy is inversely proportional to wavelength. Using the numbers provided in Figure 3-19, you can calculate that the quantum defect is only 9% for ytterbium in YAG, compared with 25% for neodymium.

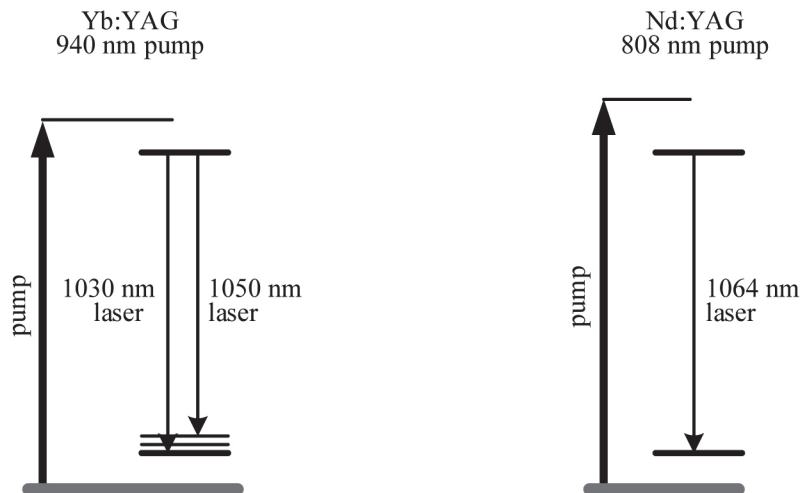

Figure 3-19 Ytterbium laser transition in YAG compared with that of neodymium. The pump line for Yb is much closer to the laser line than it is for Nd, making ytterbium the more efficient laser.

An additional attraction of ytterbium is that the lower laser level is actually a series of closely spaced states, so it can emit across a range of wavelengths, depending on how the laser resonator is adjusted. Among them is the 1064 nm wavelength of neodymium. The primary

application of ytterbium is in fiber lasers, and this application is described in more detail later in this module.

Erbium, holmium, and thulium operate at wavelengths longer than 1400 nm, which are strongly attenuated by the ocular fluid so they cannot cause retinal damage, the prime eye-safety issue in using visible and near infrared lasers. This makes them important for laser applications in the open air, where people might be exposed accidentally. Both erbium and thulium have near-infrared absorption lines that can be diode pumped: erbium at 980 and 1480 nm, and thulium at 785-793 nm. Erbium pumping at 1480 nm can be quite efficient, but diode lasers are more powerful in the 980 nm band.

Titanium-Sapphire Lasers

Titanium-sapphire lasers have gain across a wide band, from 660 nm in the red range to 1100 nm in the near-infrared range, which makes them both broadly tunable and able to generate ultrashort femtosecond pulses. Tunable output power is highest from 700 to 900 nm and can be converted into second, third, and fourth harmonics. It is largely used in research that requires either ultrashort pulses or tunable laser sources.

Titanium replaces about 0.1% of the aluminum atoms in a sapphire (Al_2O_3) crystal, much as neodymium does in YAG. However, the Ti^{+3} ions interact much more strongly with the host crystal, and the laser transition occurs between a pair of broad energy bands arising from the combination of vibrational and electronic states, called *vibronic* states. As Figure 3-20 shows, this means that both the upper and laser levels are broad bands rather than single states, so the laser transition can occur at a wide range of wavelengths. A number of solid state lasers have similar vibronic transitions, but Ti-sapphire has the broadest tuning range of any commercial laser.

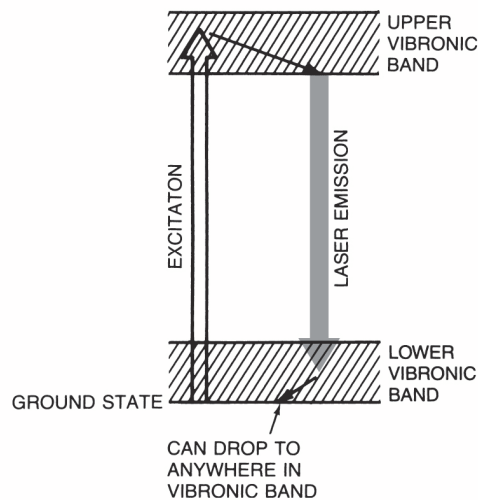

Figure 3-20 In a vibronic laser, *transitions occur between bands of energy states rather than discrete energy levels, so the laser can emit across a range of wavelengths as electrons drop from different points in one band to different points in the other.*

Ti-sapphire has a broad pump band from about 400 nm to 600 nm, with a peak at 500 nm, and requires laser pumping because of its short upper-state lifetime. Frequency doubled neodymium or ytterbium lasers are the usual pump sources, but blue diode lasers have also been used in the

lab. The material has high gain and is rarely used in high-power applications, so typically small crystals are pumped.

Ti-sapphire lasers are designed to produce either tunable output or very short pulses. Both applications take advantage of the material's exceptionally wide bandwidth, but they require different optics. Tunable lasers require laser cavities that can be adjusted to select a particular wavelength and optics that can operate across the desired tuning band; two or more sets of optics may be needed to span the whole tuning range. Ultrashort pulses require a mode locker and a set of cavity optics that spans the tuning range. Mode locked oscillators can generate pulses down to about 10 fs, and nonlinear techniques can compress pulses to a few femtoseconds.

Alexandrite Lasers

Alexandrite lasers operate on a vibronic transition of chromium atoms in a host crystal called alexandrite (BeAl_2O_4). They are tunable between about 700 and 860 nm and are used in applications that require specific wavelengths in that band.

Chromium atoms replace 0.01 to 0.4 percent of the aluminum in alexandrite. The energy levels are similar to those of chromium in ruby, but the lower laser level in alexandrite is a vibronic band rather than the ground state, as shown in Figure 3-21. Alexandrite has a strong pump band from 540 to 650 nm and can be pumped with lamps or diode lasers.

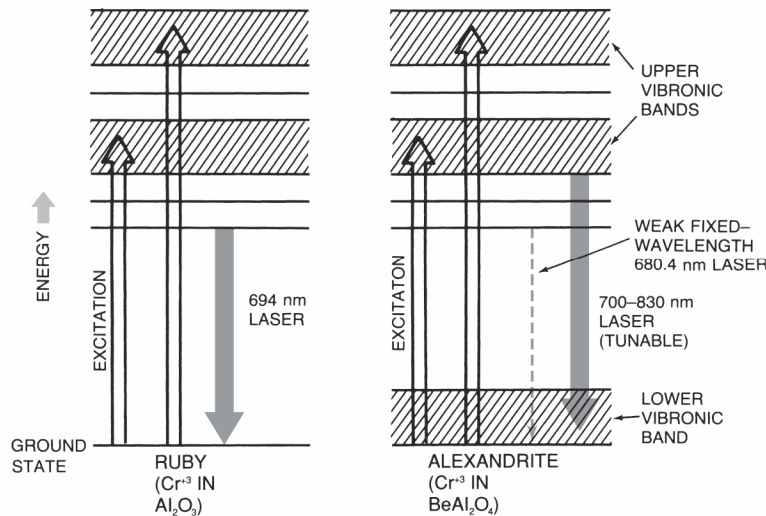

Figure 3-21 Energy levels in an alexandrite laser

Alexandrite can emit continuous wave or pulsed and can be Q-switched. Harmonic generation yields light tunable at 360 to 400 nm, 240 to 270 nm, and 190 to 200 nm.

Tunable Mid-Infrared Solid State Lasers

An emerging family of tunable mid-infrared lasers is based on doping wide-bandgap II-VI semiconductors with chromium or iron. Both metals occupy +2 states in the crystal.

Chromium atoms in zinc sulfide or zinc selenide can emit from about 2000 to 3300 nm, as shown in Figure 3-22. The lasers can operate continuous wave in in TEM_{00} mode or emit nanosecond pulses, and they use only small pieces of the laser material. Cr:ZnS and Cr:ZnSe

have pump bands at 1.5 to 2.0 μm and have been pumped by diode lasers emitting in that range in the laboratory, but commercial versions are pumped with thulium-doped fiber lasers.

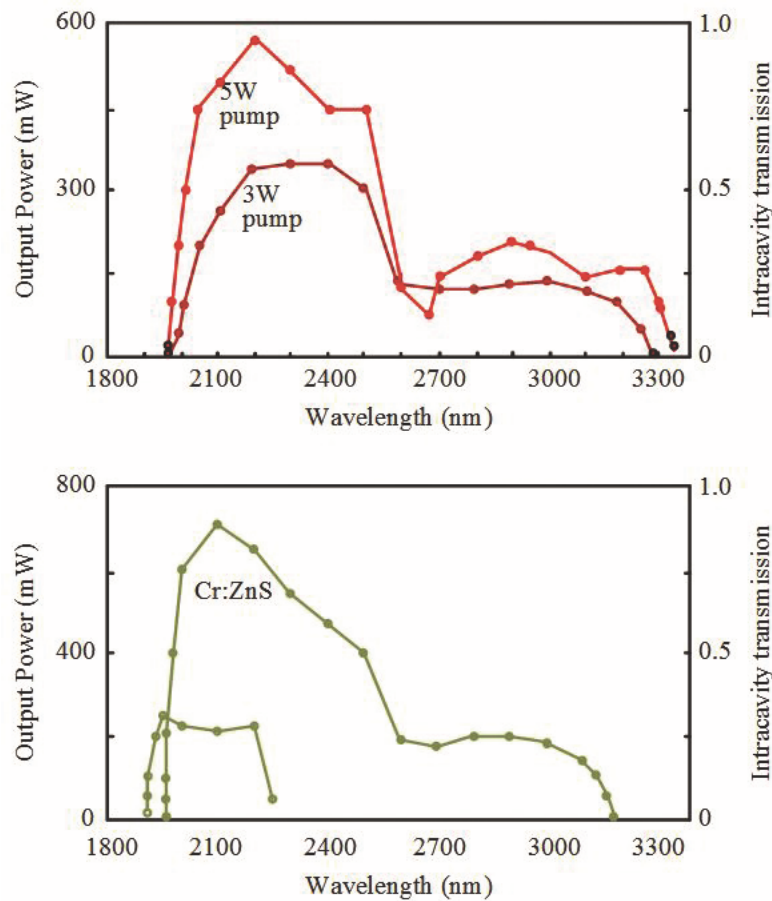

Figure 3-22 Power generated by Cr:ZnSe and Cr:ZnS lasers across their operating range, with atmospheric absorption shown in the background. (Courtesy IPG Photonics)

Iron-doped cadmium-zinc telluride (CdZnTe) lasers have a tuning range of 3.9 to 5.1 μm . With a broad pump band from 2.5 to 3.5 μm , Fe: CdZnTe lasers can operate pulsed at room temperature but require cooling for continuous wave operation. One pump source is an erbium-YAG solid state laser emitting at 2940 nm.

Fiber Lasers

A fiber laser is essentially a specialized type of solid state laser in which an optical fiber replaces the traditional rod. That seemingly small difference has such a large impact on performance that it makes fiber lasers a class in themselves, able to generate continuous laser powers from milliwatts to tens of kilowatts. Optical fiber amplifiers—essentially fiber lasers without mirrors—play an important role in fiber-optic communications, so we will cover them in the same category.

The first step in understanding fiber lasers is to review the basic concept of the optical fiber, in which total internal reflection guides light through a core surrounded by a cladding with a lower refractive index. In a standard transmission fiber, the core is very pure glass. In a fiber laser, the

glass core is doped with a light emitter such as ytterbium, which lases when optically pumped. Because the fiber guides light along its length, a fiber laser is pumped from the end, so the pump light is guided along with the laser light generated in the fiber.

Figure 3-23 shows the basic idea for a ytterbium-doped fiber laser. The 940 nm output of a pump diode is focused onto one end of the fiber, where it passes through a wavelength-selective filter that transmits the 940 nm pump beam but reflects the 1030 nm Yb emission line. The 940 nm pump excites Yb atoms in the core of the fiber, and stimulated emission from them is guided along the length of the fiber. A second wavelength-selective filter completes the laser cavity; it reflects the remaining 940 nm pump light back into the fiber but couples some of the 1030 nm Yb laser emission out into the laser beam. (Some 1030 nm Yb emission is fed back into the laser cavity formed by the filters at the two ends.)

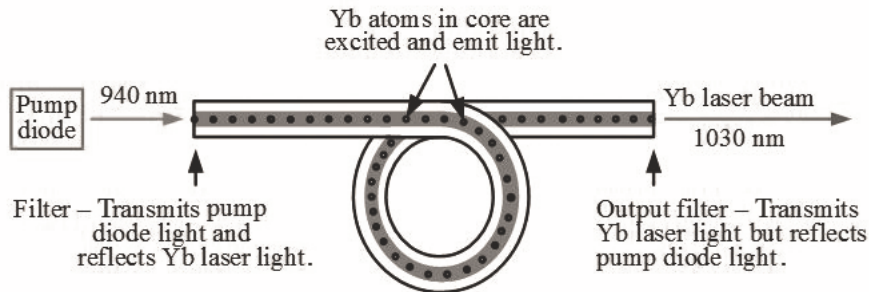

Figure 3-23 A simple Yb-fiber laser with wavelength-selective mirrors forming a laser cavity

This simple arrangement works, but it overlooks an important feature of any optical fiber: the core diameter. Confining the stimulated emission in the roughly 10 μm core of a single mode fiber produces the brightest and highest-quality beam. A single narrow-stripe diode laser could couple milliwatts of light into a 10 μm fiber, but fiber lasers require much higher pump power, and thus, a larger fiber core area to pump.

The solution to this problem is the three-layer fiber, shown in Figure 3-24. Variously called a dual-core or dual-cladding fiber, it has a small inner core doped with a light emitter in the center, surrounded by a larger outer core (or inner cladding) with lower refractive index, which in turn is surrounded by an outer cladding with even lower refractive index. The pump diodes are coupled into the large outer core, and the total internal reflection between it and the surrounding outer cladding guides the pump light along the fiber. As the pump light travels the length of the fiber, it passes repeatedly through the inner core, where it can excite the laser ion. Typically, the inner core supports only a single longitudinal mode of stimulated emission, and the outer core supports many modes of light from the pump diodes.

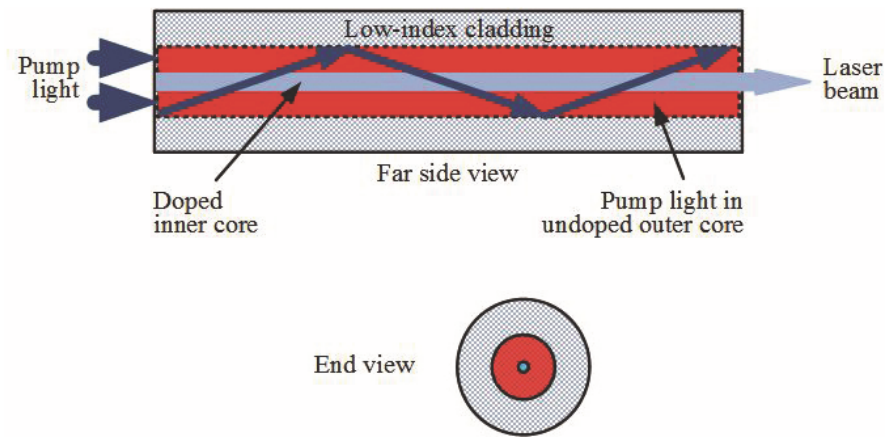

Figure 3-24 *Dual-core fiber structure*

The diode pumping of fiber lasers works very well because both are very efficient. High-power diode lasers convert roughly half the electrical input energy into laser light. A fiber laser can convert around 60% of the pump light into a beam of much higher quality. The overall wall-plug efficiency is around 30%, which is excellent by laser standards and a big attraction for materials working applications, which require a lot of power.

Fiber lasers have other advantages. Their high surface-to-volume ratio helps dissipate waste heat. They can be coupled directly to beam-delivery fibers manipulated by robots, without bulk optics that could get dirty or get knocked out of alignment. Those advantages make fiber lasers attractive for applications ranging from research to weapons for shooting down rockets, artillery, and mortars.

Three rare earth elements are the most common light emitters in fiber lasers: ytterbium, erbium, and thulium.

Ytterbium Fiber Lasers

Ytterbium (Yb) has become the most widely used fiber laser because of its high efficiency and the availability of high-power pump lasers. With peak output from 1030 to 1080 nm, ytterbium lasers are in the same range as the 1064 nm neodymium laser and can be made to emit at 1064 nm to duplicate processes using neodymium lasers. They can emit pulsed or continuous wave.

Figure 3-19 above compares the laser transitions of ytterbium and neodymium. Both the upper and lower laser levels of ytterbium have multiple sublevels, so it can operate across a range of wavelengths. Ytterbium lacks the visible pump bands needed for lamp pumping, but as mentioned earlier, a strong 940 nm absorption makes diode pumping very efficient. Other absorption bands exist at 915 and 975 nm. The lower laser level is a sublevel somewhat above the ground state that is quickly depopulated.

InGaAs diode lasers pumping dual-core fibers can generate continuous powers well over a kilowatt from Yb-doped inner cores supporting only a single transverse mode, which is desirable for the high beam quality required in materials working. Maximum output is limited by nonlinear effects proportional to the power density in the inner core and the length of fiber. Also, details of the fiber design can have effects on power level.

High-power fiber lasers require multiple pump lasers that all couple their light into the outer core. As Figure 3-25 shows, this may be done in two distinct ways. A number of pump lasers

may be connected through separate fibers to a single coupler at the end of the fiber. Alternatively, pump diodes may be “side coupled” into the fiber using an optical coupler spliced into the fiber. The coupler couples light into the outer core so that it passes along the length of the core (not perpendicular to the fiber, as you might infer from the term “side coupling”).

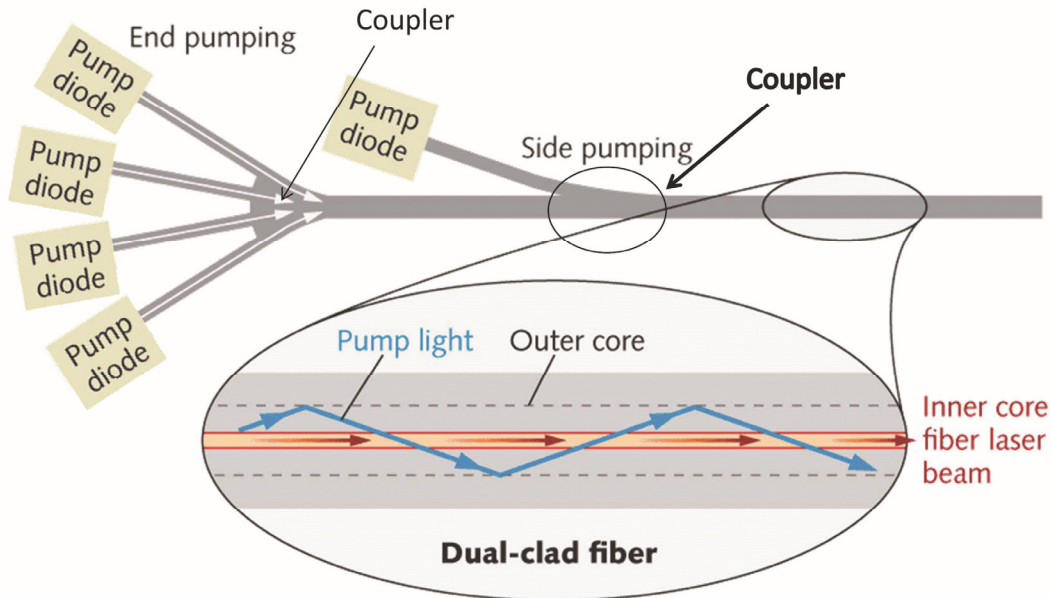

Figure 3-25 Pump diodes can direct light into the outer core of a fiber laser in two ways: through a coupler at the end, or through a coupler spliced into the length of the fiber

Like the neodymium laser, ytterbium-doped fibers can be readily used with harmonic generators and may be offered as green lasers, with doubled ytterbium usually emitting at 515 nm in the green range.

Ytterbium-doped fiber lasers are versatile, and may be operated continuous wave or in three distinct pulsed modes:

- *Long-pulse or quasi-continuous wave:* In this mode, the laser emits pulses that last from 0.2 to 20 ms at repetition rates up to 500 Hz. Timing is set by switching the pump diodes on and off. This makes the laser more effective in material removal processes than using a continuous beam power.
- *Q-switched:* Bulk or fiber-based Q-switches operate like conventional Q-switches in bulk lasers: they build up laser energy in the laser cavity and then switch cavity Q to fire pulses of 2 to 2000 ns, as described in Module 2-1.
- *Mode locked:* Mode locking can produce a series of identical ultrashort pulses that typically last from 100 fs (femtosecond, 10^{-15} s) to 1 ps (picosecond, 10^{-12} s).

Erbium-Doped Fiber Lasers

Erbium-doped fiber lasers and amplifiers emit at 1520 to 1620 nm. They are not as efficient or as powerful as ytterbium-doped fiber lasers, but their longer wavelength is necessary for fiber optic telecommunications and is beneficial for outdoor applications because the

wavelength poses little hazard compared with Nd or Yb. Examples include laser ranging, laser radar, and military equipment.

Erbium has two primary pump bands at 980 and 1480 nm, as shown in Figure 3-26. The 1480 nm band excites erbium directly to the upper laser level, so the photon deficit is very low. However, 1480 nm diode sources are not as powerful as those emitting in the 980 nm band, which is less efficient because it excites erbium to a short-lived state above the upper laser level. Ytterbium may be added to erbium-doped fibers to absorb pump photons and transfer their energy to erbium atoms.

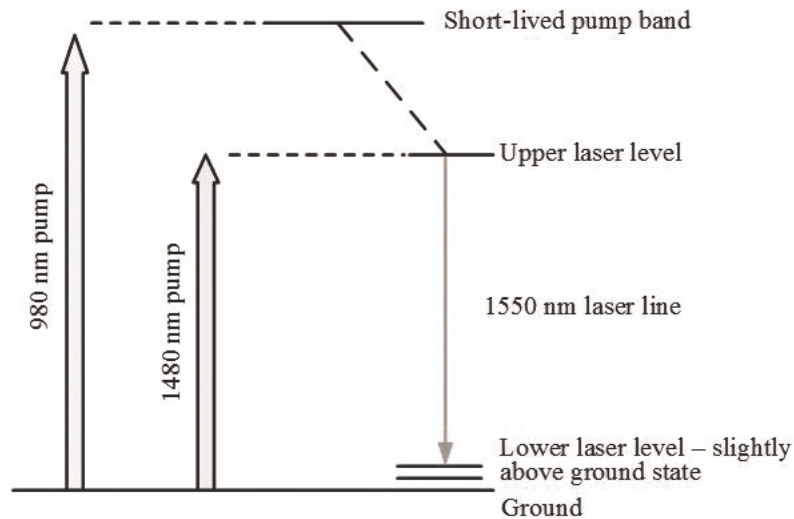

Figure 3-26 Erbium energy levels

Erbium has a broad bandwidth, making it attractive for femtosecond lasers. Femtosecond Er-fiber lasers are easier to use and more durable than bulk versions. They may be used at their fundamental band at 1550 nm or at the second harmonic of 780 nm.

Thulium-Doped Fiber Lasers

Thulium-doped fiber lasers can generate up to a couple hundred watts at 1900 to 2050 nm, or lower powers in pulses at 1750 to 2100 nm. They can be pumped at 1600 nm, but diode lasers are not very powerful in that band. GaAlAs diode lasers can excite thulium at 793 nm to a high-level transition, shown in Figure 3-27. That excited atom then drops to the upper laser level of the 2000 nm transition. The energy released in dropping to the upper laser level can transfer to a second thulium atom, exciting it to the upper laser level of the 2000 nm transition. Thus, one pump photon with a lot of energy can produce two laser photons.

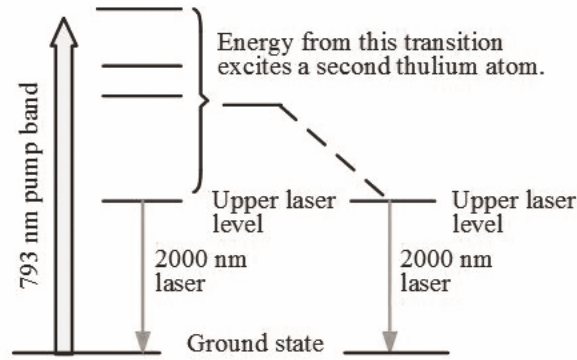

Figure 3-27 How a single pump photon can excite two thulium atoms to the upper laser level. The trick is getting the thulium atom that absorbed the light to transfer some of the energy to a second thulium atom, exciting it to the upper laser level.

Thulium wavelengths are attractive for welding and cutting plastics, as well as for medical applications and pumping some lasers that emit at longer infrared wavelengths. Pulsed thulium lasers also can pump optical parametric amplifiers and mid-infrared lasers and can perform open-air pollution measurements.

More details on how fiber lasers operate can be found in Module 2-5 of this course.

Semiconductor Lasers

Semiconductor lasers have become the most important type of laser, with billions sold for use in consumer products, particularly optical disk players for audio and video. The vast majority of semiconductor lasers are diodes, in which electronic current flows between a region where current is carried by free electrons (*n*-type material) and a second region where the current is carried by “holes” (*p*-type material) that are vacancies in the electron shells of atoms in the semiconductor. These devices are called *diode lasers*.

The basic concepts of semiconductor electronics should be familiar from your electronics courses, but we review the workings of light-emitting diodes (LEDs) because they are a stepping-stone on the way to diode lasers. An LED emits light spontaneously when an electron in the high-energy conduction band recombines with a hole in the lower-energy valence band, releasing the difference in light energy, shown as the “band gap” energy in Figure 3-28.

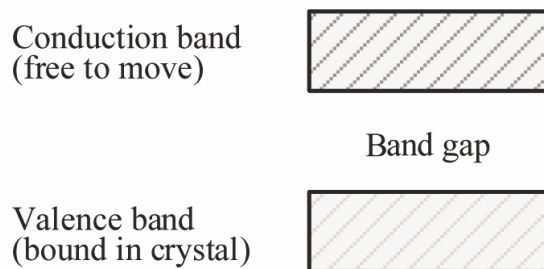

Figure 3-28 Energy bands in a semiconductor. LEDs and diode lasers emit light carrying the band-gap energy that is released when an electron drops from the conduction band into the valence band.

This recombination process occurs in an LED when a current flows through the diode, as shown in Figure 3-29. The electric field in the junction area pulls the positive holes and the negative electrons toward the junction of the *p*- and *n*-type materials, where the two combine to form a quasiparticle called an exciton. Eventually, the electron drops into the valence band, spontaneously emitting its excess energy as a photon in a process known as *spontaneous emission*.

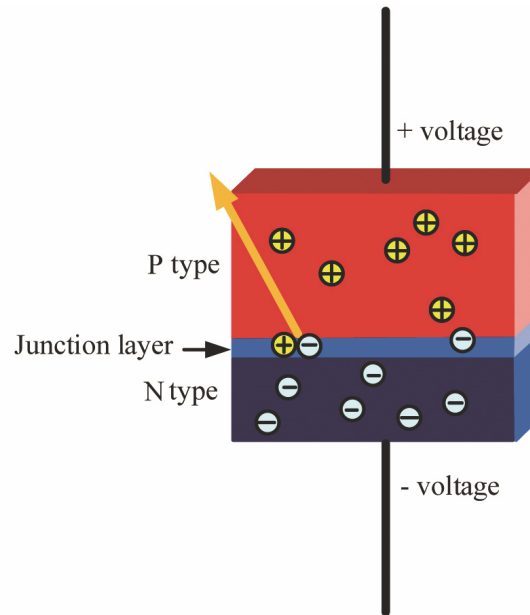

Figure 3-29 Positive and negative carriers combine at the junction between *p*- and *n*-type semiconductors, releasing light in an LED

Diode lasers are much busier devices. Much more current flows through them, creating more excitons emitting many more photons—so many that they stimulate other excitons to emit their extra energy as identical photons that produce more stimulated emission. In contrast to LEDs, diode lasers also have reflective surfaces that feed photons back into the resonant cavity to enhance the stimulated emission process. At low current, a diode laser acts like an LED, but as the drive current increases, it crosses the threshold for laser operation, and stimulated emission dominates. As Figure 3-30 shows, light output rises slowly when spontaneous emission dominates, but as laser threshold is crossed, a cascade of stimulated emission stimulates more emission, and output rises very quickly. A similar process occurs in all other lasers, but the details are specific to diode lasers and depend on the nature of the semiconductor.

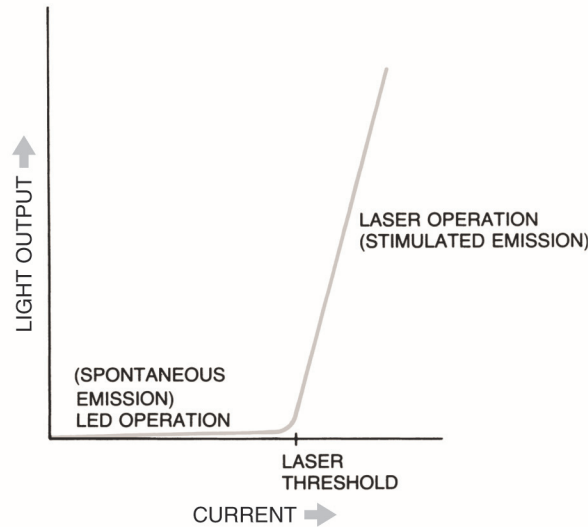

Figure 3-30 Threshold in a diode laser marks the change from spontaneous emission of an LED to stimulated emission in a laser

Light Emission and Compound Semiconductors

The rules that govern electronic transitions in semiconductors are complex. We will avoid this complexity by simply stating that for excitons to release their energy as photons in a semiconductor, the semiconductor must have a *direct bandgap*. If the semiconductor does not have a direct bandgap, then exciton energy is released as heat within the crystal.

Silicon does not have a direct bandgap, so silicon diodes emit almost no light and have not been made into lasers, despite long efforts to make silicon lasers. However, many compound semiconductors, such as gallium arsenide and gallium nitride, have direct bandgaps and make good LEDs and diode lasers. We will come back to the important matter of materials later, after describing the basics of diode lasers in general.

The two key factors that set diode lasers apart from LEDs are feedback from a laser resonator and a strong drive current. The simplest diode lasers look like the LED in Figure 3-29 but have mirrors on two opposite sides. They work better if the drive current and laser light are confined to a narrow stripe in the junction layer, as shown in Figure 3-31.

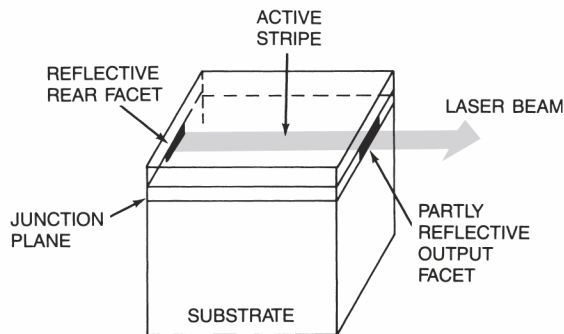

Figure 3-31 A simple stripe-geometry diode laser. Current flow is vertical and confined to a stripe in the junction about $5\ \mu\text{m}$ wide and 300 to $500\ \mu\text{m}$ long—the length of the crystal (horizontal). In this example, the right edge of the chip is the output mirror, and the left edge is a total reflector.

You can think of the stripe as a tiny rectangular rod of laser material in which one end is the output mirror and the other is a total reflector. The output mirror often is not coated, because compound semiconductors have a high refractive index and reflect about a third of the light back into the laser stripe.

Diode lasers produce a steady beam if the current flow is constant. They emit a series of pulses if the current is switched off and on by modulating the drive current with a suitable signal. Such direct modulation is fast enough for data communications up to about a gigabit per second, but has subtle imperfections that cause noise at higher data rates. That noise can be avoided by passing a continuous beam through an external optical modulator that switches the beam off and on much faster but at higher cost and complexity.

Laser Diode Structures

The narrow-stripe diode laser shown in Figure 3-31 is an example of an edge emitter, the simplest type of diode laser. Narrow-stripe versions emit milliwatt-level powers and have high enough gain that they do not require a highly reflective output mirror.

One important limit of the stripe-geometry laser is its emission of light from an area about one wavelength high by several wavelengths width. The divergence of a laser beam at a wavelength λ from an aperture of width d increases with the ratio λ/d , which means that divergence is quite large for edge-emitting diode lasers. Typical measured values are about 10 degrees in the plane of the junction and 40 degrees perpendicular to the junction, as shown in Figure 3-32. Suitable focusing optics can narrow this divergence, as is obvious in a red diode-laser pointer.

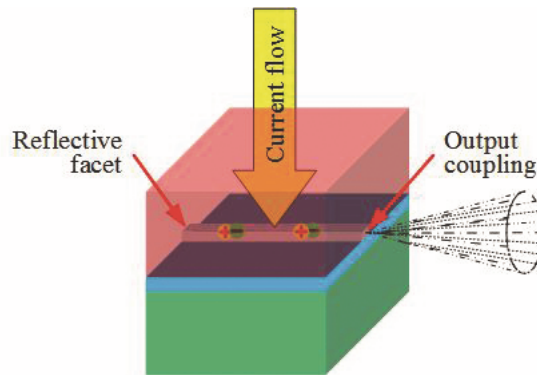

Figure 3-32 *Beam divergence from an edge-emitting diode laser*

One way to increase power from edge-emitting diode lasers is to make the stripes wider. Another is to fabricate several parallel stripes on a single wafer and collect their output into a single beam or a single optical fiber. Figure 3-33 shows a single array of several parallel stripes. Several such arrays can be fabricated together as a laser “bar” with many emitters; this bar can generate continuous output to about 100 watts.

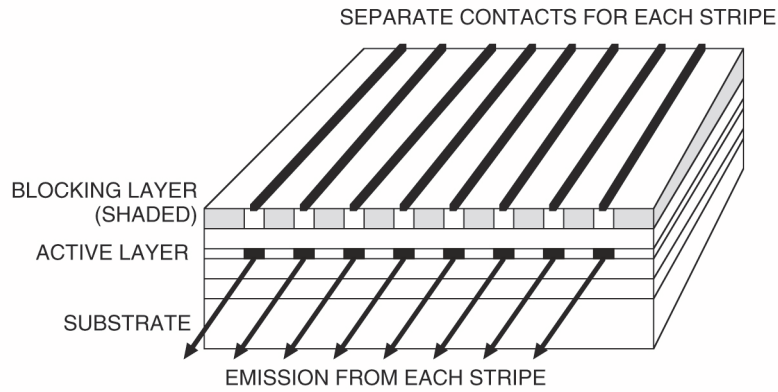

Figure 3-33 *Output of an array of several parallel stripes on a single chip can be combined to generate higher powers. Several arrays can be combined in a monolithic laser bar, and bars can be stacked together to form a "stack."*

Even higher powers can be produced by stacking many wafers together to form a “stack” of diode lasers. Stacks of high-power diode-laser bars can generate kilowatts of power from quite modest volumes, but they require active water cooling.

An alternative to the edge-emitting laser is the vertical cavity surface emitting laser, or VCSEL. As the name implies, the laser cavity is perpendicular to the plane of the chip, with reflectors on the top and bottom of the wafer rather than on the edge. The mirrors typically are multilayer distributed Bragg mirrors fabricated from the same semiconductors used in the laser, as shown in Figure 3-34, but in some cases, one reflector may be another material deposited on the wafer surface.

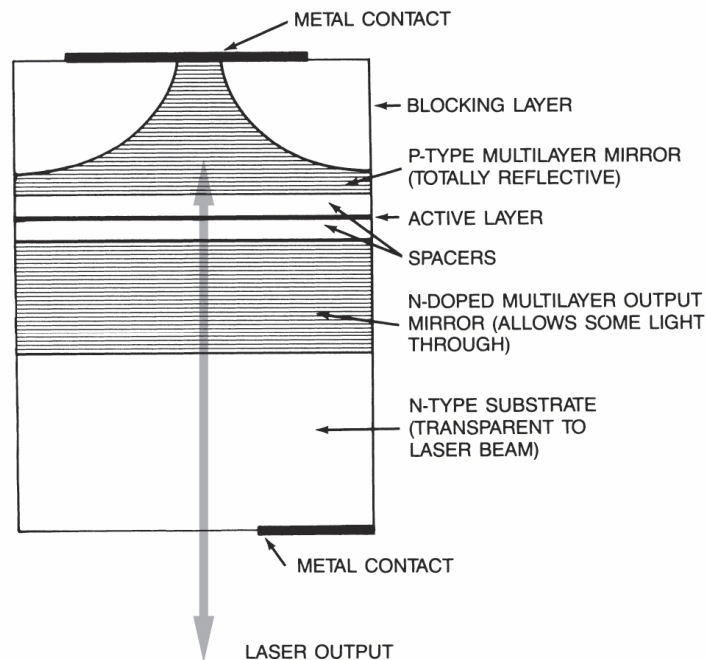

Figure 3-34 *Cross-section of a VCSEL, showing the layering of mirrors*

Rearranging the mirrors makes a VCSEL a different device than an edge emitter. The VCSEL contains only a very thin layer of active material, so the round-trip gain in the cavity is small. This means that the top and bottom mirrors have to be very highly reflective and couple only a small fraction of the power generated in the laser in the output beam. Because the cavity is very short, longitudinal modes are widely separated, making narrow-line emission easier than in edge emitters. Single VCSELs are low-power devices with low thresholds, making them attractive for such applications as short data links.

A VCSEL can be made with a circular output aperture tens of micrometers in diameter, to produce a lower-diffraction circular beam that is easier to use in many applications than the oval, highly divergent edge-emitter beam. VCSELs also can be fabricated in arrays spread across a surface to produce higher powers, but these arrays cannot reach the high powers available from edge-emitting bars and stacks.

Light-Emitting Semiconductors

So far, we have talked about diode lasers in general terms. The wavelength and other key operating details depend on the properties of the specific semiconductors used in the device.

Diode lasers generally are made from a family of compound semiconductors that combine elements from group III of the periodic table, including gallium, aluminum, and indium, and group V, including nitrogen, phosphorous, arsenic, and antimony. In practice, compounds of three or four elements are deposited in thin layers on a substrate made from a pure binary material that is easy to produce in bulk, such as gallium arsenide or indium phosphide.

Figure 3-35 shows bandgap energies and wavelengths for these materials, along with the spacing of atoms in their crystal lattices. Lattice matching is important in crystal growth, because the atoms in successive layers of different composition need to be spaced similarly to prevent flaws from forming. If two layers do not match closely, depositing a series of strained layers with graduated spacing can help reduce strain to manageable levels. Table 3-7 lists important diode-laser materials and their usable wavelength ranges. LEDs can emit over a broader range.

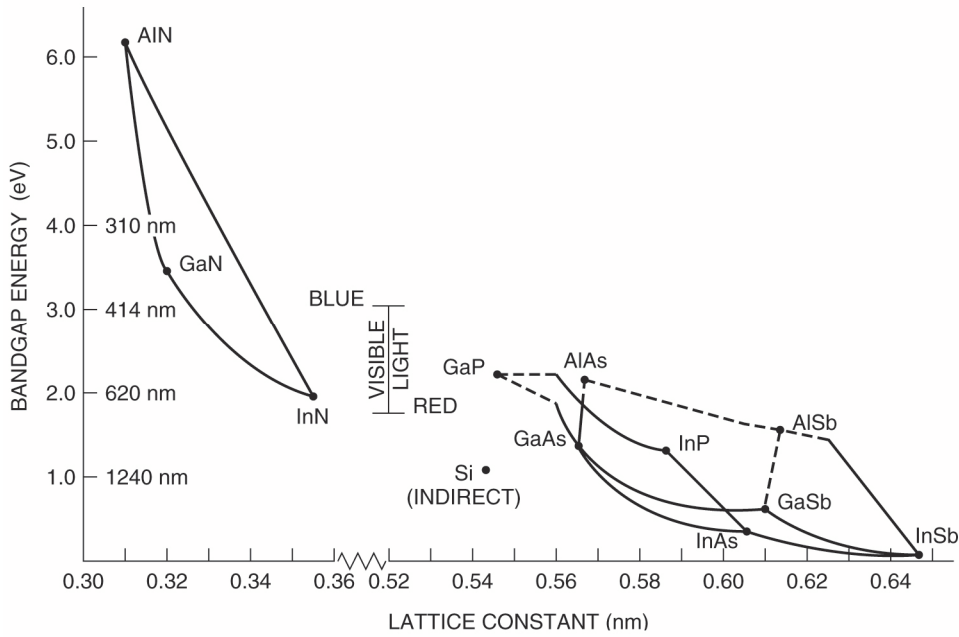

Figure 3-35 Bandgap energy (in electron volts and wavelength) and lattice constants for selected III-V semiconductors, with silicon included for comparison. Dashed lines show compounds with indirect bandgaps.

Table 3-7 Major Diode Laser Materials and Wavelengths

Active Layer/Substrate	Usable wavelength range	Comments
GaInN/various	375-525 nm	Best in UV, violet, and blue; green also available but not as well developed
AlGaInP/GaAs	620-680 nm	Commercial
Ga _{0.5} In _{0.5} P/GaAs	670-680 nm	Commercial
GaAlAs/GaAs	750-900 nm	Commercial
GaAs/GaAs (pure)	904 nm	Commercial
InGaAs/GaAs	915-1050 nm	Strained layer; Commercial
InGaAsP/InP	1100-1650 nm	Commercial
InGaAsSb	2-5 μm	Some commercial
PbCdS	2.7-4.2 μm	Requires cooling
PbSSe	4.2-8 μm	Requires cooling
PbSnTe	6.5-30 μm	Requires cooling
PbSnSe	8-30 μm	Requires cooling

Gallium Aluminum Arsenide (GaAlAs) Diode Lasers

Diode lasers with active layers of pure gallium arsenide emit at 904 nm; those with active layers of gallium aluminum arsenide emit between 750 and 900 nm. Both are deposited on GaAs substrates. GaAlAs and other three-element (ternary) compounds consist of equal numbers of atoms from the two groups, so the number of gallium atoms plus the number of aluminum atoms equals the number of arsenic atoms. The formula is sometimes written $\text{Ga}_{(1-x)}\text{Al}_x\text{As}$, where x is a number between 0 and 1. The wavelength decreases as the fraction of Al atoms increases, but reliability becomes low for wavelengths shorter than about 750 nm.

GaAlAs is widely used in applications including short-distance data links, playing compact disc audio, pumping neodymium lasers, and some types of materials working. Power levels range from milliwatts to kilowatts (from stacks). Note that it is also written AlGaAs; as with other such compounds, the Group III elements are written first and the order is somewhat arbitrary.

Red Diode Lasers (GaAlInP/GaAs)

The red diode lasers used in laser pointers and many other low-power visible applications are based on compounds of aluminum, gallium, indium, and phosphorous deposited on GaAs substrates. The number of aluminum, gallium, and indium atoms together equals the number of phosphorous atoms, and the formula can be written $\text{Ga}_{(1-x-y)}\text{Al}_x\text{In}_y\text{P}$. AlGaInP/GaAs lasers can operate at 620 to 680 nm. If an aluminum-free version of this compound, GaInP/GaAs, is used, a laser with an output at 670 nm results. The 670 nm wavelength is used for DVD players. Red laser pointers and other applications requiring visibility typically use 635 nm, a wavelength to which the human eye is much more sensitive than 670 nm.

Indium Gallium Arsenide (InGaAs) Diode Lasers

Indium-gallium arsenide (InGaAs) diode lasers on GaAs substrates operate at wavelengths between 915 and 1050 nm, where stacks can produce up to kilowatt-class power. The wavelength increases with the fraction of indium in the compound. Major uses include materials working and pumping ytterbium and erbium fiber lasers and amplifiers.

InGaAsP/InP Diode Lasers

Most diode lasers described so far contain only three elements, but a large and important group are fabricated from blends of four elements—indium, gallium, arsenic, and phosphorous—and are grown on substrates of InP. Like such compounds as InGaAs, InGaAsP compounds are made by mixing equal numbers of atoms from Groups III and Group V. But in the four-element (quaternary) compound, the total number of indium and gallium atoms must equal the total number of arsenic and phosphorous atoms, as illustrated in the formula $\text{In}_{1-x}\text{Ga}_x\text{As}_{1-y}\text{P}_y$.

The ability to adjust both the In/Ga and As/P ratios makes it possible to both produce the desired bandgap and match the lattice spacing to the InP substrate over a wide range of wavelengths, from 1100 to 1650 nm. The main use of InGaAsP lasers is in fiber-optic communication systems operating between 1300 and 1550 nm. As with other diode lasers, output powers range from milliwatts to watts or higher in arrays, but InGaAsP has not been developed for the high powers needed for laser pumping or materials working.

Nitride Diode Lasers

Indium-gallium nitride diode lasers emit in the ultraviolet, blue, and green parts of the spectrum, from about 375 to 525 nm. The bandgap of pure GaN is close to 375 nm, and adding indium

reduces the bandgap and increases the wavelength. Developers are now working to push to green wavelengths longer than 525 nm, but laser performance has been limited by problems arising from the increased indium concentration. Wavelengths shorter than 375 nm are in development and require adding aluminum to GaN. InGaN lasers can be fabricated on substrates, including pure GaN, sapphire (Al_2O_3), and silicon carbide (SiC).

The first GaN lasers were designed to emit at 405 nm for playback of high-resolution video recorded on optical disks, using the Blu-ray format. Other applications followed, made possible by the versatility of the material. InGaN LEDs emitting at 445 nm are the basis of most solid state lighting; the blue light illuminates phosphors, which fluoresce at longer wavelengths to make white light. Solid state lighting has become a larger-scale application than Blu-ray players and is driving new development in nitride materials. The interest in green diode lasers comes from potential applications in compact color projectors based on diode lasers; red and blue lasers are already available, but a green laser is needed for full color. Blue diode lasers also can replace more expensive blue gas lasers for applications such as fluorescence sensing.

Antimonide Diode Lasers

Replacing arsenic in III–V semiconductors with antimony (Sb), the heaviest nonmetallic group V element, reduces the bandgap. GaSb has a bandgap of 0.7 eV, about 1800 nm, compared with 1.43 eV (905 nm) for GaAs. Adding indium stretches wavelength beyond 1800 nm. Commercial InGaAs diode lasers are available at wavelengths from 1870 to 2200 nm, with output up to one watt from a single laser and up to 10 W from a one-centimeter bar. Laboratory devices can operate at room temperature to wavelengths as long as 3500 nm, but high power is only available at shorter wavelengths. Antimonide wavelengths are used for welding and cutting plastics, laser pumping, and measurement applications.

Lead Salts and Other II–VI Diode Lasers

Diode lasers can be made from compound semiconductors with direct bandgaps made from elements in Groups II and VI of the periodic table. II–VI diode lasers made of lead, tin, sulfur, selenium, and tellurium are tunable between 4 and 30 μm in the infrared, but require cryogenic cooling and are limited to research applications. Green diode lasers have been made from zinc selenide mixed with magnesium or tellurium. Related compounds, including tellurium and sulfur, have demonstrated laser action over a wider range of applications, but those lasers remain in the laboratory.

More details on how diode lasers operate can be found in Module 2-6 of this course.

Non-Diode Light-Emitting Semiconductors

Quantum Cascade Lasers

One important non-diode semiconductor laser is the quantum cascade laser (QCL), which gets its name from the cascade of light produced by electrons passing through a series of identical quantum wells in a semiconductor. Like diode lasers, they are made of III–V compounds, but the internal structures are different, and electrons are the only carriers. QCLs are best developed at wavelengths of 4 to 12 μm , but they can emit at wavelengths up to hundreds of micrometers. Figure 3-36 shows how the concept works schematically.

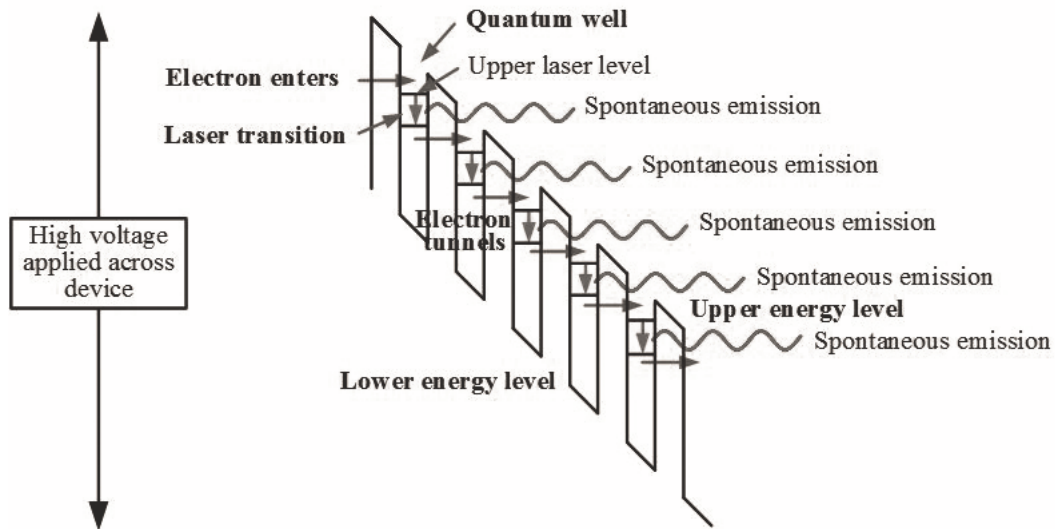

Figure 3-36 Operation of a quantum cascade laser, with a single electron emitting a series of photons as it drops through a series of quantum wells

This figure shows a voltage applied across a stack of quantum wells. The vertical axis shows the voltage relative to a ground level. An electron starts at the top and passes through the bulk semiconductor into the first quantum well, where it drops from the upper laser level to the lower level, initially emitting a photon spontaneously. Then the electron tunnels through the barrier layer to a second quantum well, where it drops from the upper laser level to the lower level. Once the cascade of photons has started, it is stimulated to emit a photon, and then it tunnels through to the next quantum well. The process repeats all through the series of identical quantum wells, with the electron dropping an increment of voltage and emitting a photon at each step. (The slant in the structure shows the voltage drop at each step.)

The QCL structure lacks a *p-n* junction and thus is not a diode. The only carriers are electrons, each of which emits multiple photons as it passes through the series of quantum wells. In diodes, by contrast, each recombination produces only one photon. Each QCL transition is relatively small, with energy a fraction of an electron volt, corresponding to a wavelength of 3 μm or longer. Most diode wavelengths are shorter, with higher energy. QCL transitions have wide bandwidths, but multiple lasers are needed to scan a band of several micrometers.

Quantum cascade lasers can emit up to a few watts in the bands where the technology is best developed: 4 to 5 and 8 to 10 μm . Their primary applications are in infrared measurements and spectroscopy, but the 4 to 5 μm band is also being developed for infrared countermeasures and protection of aircraft against shoulder-launched missiles attempting to target their hot engines.

Optically Pumped Semiconductor Lasers

Another non-diode semiconductor is the optically pumped semiconductor laser (OPSL). These are VCSEL-like structures that are pumped optically by diode lasers rather than excited electrically by current passing through a diode. Because of that structural similarity, OPSLs also are called vertical external cavity surface-emitting lasers (VECSELs).

OPSLs are thin disks with reflective rear surfaces mounted on heat sinks that are optically pumped with diode lasers, like the thin disk solid state laser shown in Figure 3-16. However, as Figure 3-37 shows, the internal structures are different. The thin OPSL disks include a series of

quantum wells and a distributed Bragg reflector. Pump photons excite electrons into the conduction band in the quantum well, where they remain in an excited state until they recombine with holes and emit light. Note that the excitation in an OPSL is optical, not electronic as it is in a diode laser.

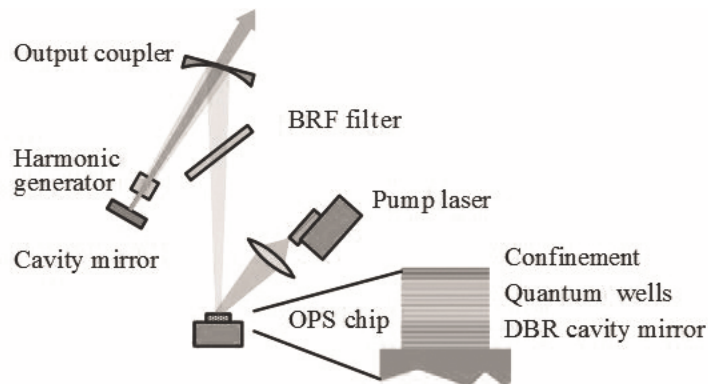

Figure 3-37 An optically pumped semiconductor laser (OPSL) in a reflective cavity. The OPSL is a thin disk containing a stack of quantum wells and a reflector, but it does not contain a diode junction or current guiding structures. The folded cavity can include a harmonic generator, to double the OPSL's near-infrared fundamental output to visible wavelengths.

The advantage of optically pumping the OPSL is that it avoids the need for electrical contacts, *p*- and *n*-type material, and other paraphernalia associated with controlling the flow of electrons through the semiconductor. That makes it easier to make a laser work, so an OPSL can produce wavelengths not available from diode lasers. Harmonic generation shifts near-infrared output into the visible range, where OPSLs can produce watts of power at wavelengths from 355 to 639 nm—wavelengths that few other sources can produce. Their high efficiency makes them effective replacements for more costly argon lasers, and they can produce yellow lines not readily available from any other laser. Applications include measurements, biophotonics, and holography.

Other Lasers and Laser-Like Sources

Inevitably, a few types of lasers and laser-like sources do not fit into the standard categories. The most important are the tunable dye laser, the free-electron laser, and optical parametric oscillators and amplifiers.

Tunable Dye Lasers

Organic dyes fluoresce brightly when illuminated by short wavelengths. When dissolved in solution, they can be placed inside a laser cavity and optically pumped by another laser or with a flashlamp. The complex dye molecules have broad emission ranges, and their laser emission can be tuned across bands up to several tens of nanometers wide.

Figure 3-38 shows the workings of low-power tunable dye lasers. A pump laser focuses light onto a cell containing a dye solution, exciting the dye molecules and producing stimulated emission that oscillates along the length of the laser cavity formed by the output mirror and a reflective diffraction grating. The grating is tuned to select the wavelength that oscillates inside the laser cavity. More elaborate cavities are needed to tune the laser to emit a very narrow range of wavelengths. Sealed dye cells are used for low-power pulsed pumping, but high-power and

continuous wave operation require a flowing dye jet because intense light and heat degrade dyes. Dyes also can be pumped by flashlamps in a different optical configuration. An etalon acts as an optical resonator, and is formed by a pair of parallel mirrors.

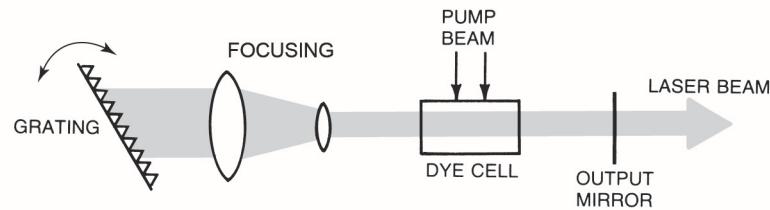

(A) Grating-tuned dye laser (pumped by pulsed laser).

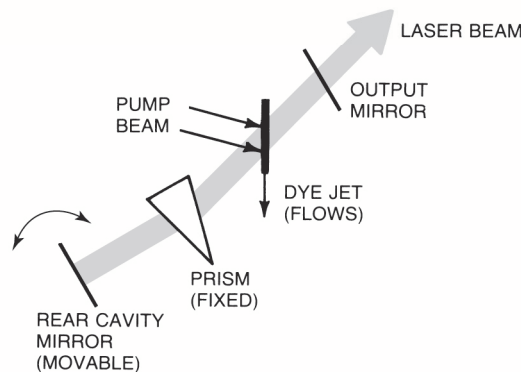

(B) Prism-tuned dye laser (pumped by continuous-wave laser).

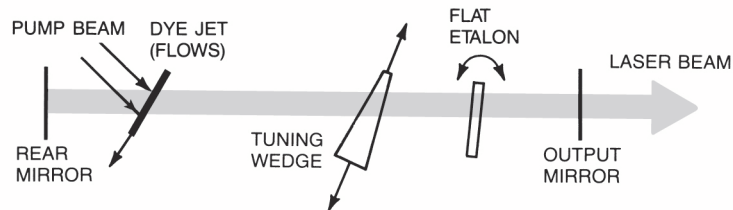

(C) Etalon-tuned dye laser (pumped by continuous-wave laser).

Figure 3-38 Simple, low-power, tunable dye lasers

Hundreds of laser dyes are available with wavelengths ranging from the ultraviolet range well into the infrared range. Each dye has a bandwidth of 10 to 70 nm, so several are needed to tune across the visible spectrum, but dye lasers offer broad wavelength coverage. Dye laser operation usually requires considerable attention; the lasers can be complex, many dyes and liquid solvents are hazardous, and the spent dyes are toxic waste. Some dye lasers have been used in medicine, but most applications today are in research and measurement.

Free-Electron Lasers

The free-electron laser is an unusual type powered by a beam of high-energy electrons from an accelerator passing through an array of magnets with alternating polarity. The array of magnets, called a wiggler or undulator, bends the beam back and forth. When a magnet bends the beam, the electrons radiate short-wavelength light, as shown in Figure 3-39. Stimulated emission from other electrons as their paths bend amplifies the light. The wavelength generated depends on the

spacing of magnets in the array and the energy of the electrons, so output can range from infrared to X-ray wavelengths. No single free-electron laser can operate across the whole range, but tuning is possible by changing electron energy or moving the magnets.

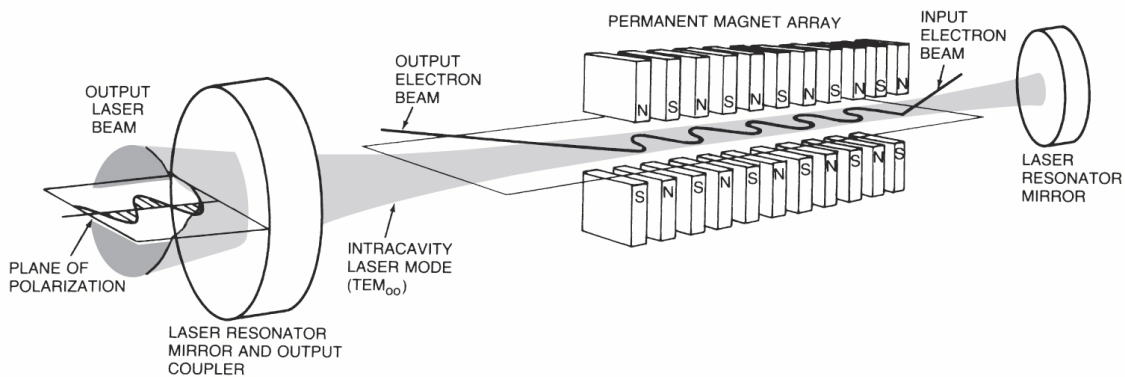

Figure 3-39 Operation of a free-electron laser. High-speed electrons pass through an array of magnets, which bend the beam back and forth. The electrons radiate light when their paths are bent, as shown in the inset, producing a laser beam. (Courtesy of University of California at Santa Barbara Quantum Institute.)

At visible, infrared, and near-ultraviolet wavelengths, cavity optics (not shown in the figure) can help build up a coherent laser beam. However, no suitable optics are available at X-ray wavelengths, so free-electron lasers operating in that range produce self-amplified stimulated emission in a process that causes the electrons to group together in microbunches that generate ultrashort X-ray pulses. Important facilities include the LINAC Coherent Light Source at the SLAC National Accelerator Laboratory in California and the European Free-Electron Laser (XFEL) in Hamburg, Germany. Free-electron lasers are tools for research and measurement applications.

Optical Parametric Oscillators and Amplifiers

Nonlinear optical effects in resonant cavities can generate laser-like light in a tunable laser-pumped device called an *optical parametric oscillator* or OPO. The strong pump beam is focused into a nonlinear material where a process called *three-wave mixing* splits the high-frequency pump beam into two lower-frequency beams, one called the signal and the other called the idler. The sum of the signal and idler frequencies equals the pump frequency.

In an OPO, the nonlinear material is inside an optical cavity that resonates at one or both of the signal and idler frequencies. The OPO can oscillate once the power reaches a laser-like threshold if the cavity has net gain at one or both of the signal and idler frequencies. Usually, only one frequency oscillates. OPO output wavelength is tuned by changing the resonant frequency. An OPO can be tuned so that its signal and idler beams are at the same frequency. When the two frequencies match, pump photons produce matched pairs of photons with half the pump frequency. This is one way to produce entangled photons for quantum-mechanics research.

An *optical parametric amplifier* or OPA works similarly, but focuses the pump beam into a nonresonant cavity illuminated by a weak beam at the signal or idler frequency. This transfers energy from the pump beam to the frequency of the weak input beam.

When pumped by a near-infrared beam from a neodymium laser, an OPO can generate pulsed or continuous light at 1400 to 4200 nm. An OPA can amplify the signal beam at 1150 to 1600 nm or the idler beam at 1600 to 2600 nm.

Present Laser Applications

The last section introduced you to a wide variety of laser types. An obvious question is “Why is there such a wide variety of lasers?” The answer is that lasers enhance the performance and quality of devices, processes, and products that are used in and result from a broad array of technical areas. Industry leaders recognize lasers as an enabling technology that allows other technologies to surpass expectations and maintain standards that once were thought unattainable.

In today’s workplace, lasers are nearly everywhere. Lasers are used in a wide variety of ways, from transferring information through the Internet to resurfacing skin and cutting sheet metal. We can’t list all the variations, but we can sample the most important and interesting types of applications.

Lasers in Communications

One of the first applications envisioned when the laser was being developed was using the high frequency of light to transfer information much faster than is possible at lower radio frequencies. Visible light has frequencies of several hundred terahertz, compared with 500 to 1600 kHz for the AM radio band in the United States, several hundred megahertz for the television broadcast band, and 2.4 GHz (billion hertz) for the microwaves that carry Wi-Fi signals.

Laser beams can send signals through the air or outer space, but mostly they transmit them through optical fibers so incredibly clear that half the light intensity still remains after traveling through 15 km of glass fiber. A single fiber can transmit more than one terabit per second—the equivalent of two Blu-ray disks per second—and one cable contains many fibers. Fiber-optic cables are the backbone of the global telecommunications network, and if you live in a metropolitan area, they probably come within a few blocks of your home.

Laser Functions in Communications

Diode lasers generate the signals carried by optical fibers. Each fiber may carry light from one laser transmitter or multiple transmitters, each at a different wavelength. Like radio signals transmitting through the air at different radio frequencies without interfering with one another, laser transmitters at different wavelengths can send signals through a fiber without interference. That technique, called wavelength-division multiplexing (WDM), multiplies the fiber’s transmission capacity.

Optical fibers attenuate laser signals very weakly, but after traveling more than about 100 km, the light needs to be amplified. Erbium-doped fiber amplifiers can simultaneously amplify signals on many separate wavelengths, sending signals through thousands of kilometers of fibers spanning oceans and continents.

Laser Types Used in Communications

Diode lasers are used in most of the global fiber network. Erbium-doped fiber lasers can produce higher powers, so they are used in some local networks where signals are distributed all

the way to homes through fiber and so must be split between a few dozen homes. LED transmitters are used in some short, low-speed data links.

Diode lasers are used in all three “windows” for communication through glass fibers. The first window, at 800 to 850 nm, was chosen to match the wavelength of GaAlAs diode lasers where glass fibers have loss of about 2 decibels per kilometer. This window is now used only for short fiber links. InGaAsP diode lasers are used in both the second window, near 1300 nm, and the third window, around 1550 nm, where fiber loss reaches a minimum of less than 0.2 dB/km. Erbium-doped fiber amplifiers and erbium-fiber lasers both operate in the third window.

Diode laser transmitters are switched on and off at rates up to about 10 Gbit per second. For transmission at higher rates—40 or 100 Gbit per second and up—diode lasers are modulated with complex waveforms.

For more details on how lasers are used in communication, go to The National Center for Optics and Photonics Education (OP-TEC) website (www.op-tec.org) and download a copy of the Photonics-Enabled Technologies (PET) series publication entitled *Principles of Fiber-Optics Communication*.

Lasers in Manufacturing

Laser beams can cut, weld, etch, and otherwise modify a wide range of materials that absorb their light. Lasers produce powerful, monochromatic light that can be focused precisely onto a small spot or dispersed evenly over a larger area. Energy from the laser beam may melt or vaporize materials, or it may trigger other reactions that alter materials.

An important attraction of laser machining is that it is a noncontact process. Blades may cut some materials more efficiently, but they also wear out. Laser beams don't become dull, and they don't distort flexible materials when they cut them. Laser beams can also cut very hard materials such as titanium or diamond, both of which quickly wear out drills or other tools. The beams can be pulsed or emit a continuous beam, as necessary to perform the desired operations.

Laser Functions in Manufacturing

Lasers deliver energy to alter a material. There are countless examples of how lasers can be used, but they break down into a limited number of operations:

- *Cutting*, by removing a narrow slice of material from a sheet of metal, plastic, or other material. The beam power melts, vaporizes, or burns away the material, leaving a gap in the original material. A jet of air, nitrogen, or oxygen may assist the process by blowing the liquid away or igniting the hot material.
- *Drilling*, by firing laser pulses at a target. Each pulse vaporizes material, and firing a series of pulses drills deeper and deeper.
- *Welding*: heating the junction of two objects made from the same material or compatible materials so the materials melt together. With a proper heating and cooling cycle, the melted material solidifies with nearly as much strength as the original material.
- *Heat treating*, which heats the surface of a material to make it harder and more resistant to wear.
- *Ablating, etching, patterning, or marking*, which remove surface material either to shape structures or to mark the surface. Ablating, with picosecond or femtosecond pulses, heats

the surface so fast that it blows it away before the laser can heat lower layers. This makes it possible to work on soft or brittle materials without damaging them.

The success of the process depends on the type of the laser and the material. Some materials are particularly bad for laser cutting. Foods tend to char, so laser slicing of bread produces burnt toast.

Laser Types Used in Materials Working

Materials working requires lasers powerful enough to remove or alter at least the surface of a material, and cutting, drilling, and welding require even more power than that. This limits most materials working to the most powerful and intense lasers: carbon dioxide, neodymium, and fiber lasers. High-power diode arrays and stacks do not generate as much intensity, but they are used for broad-area applications such as heat treating and for applications such as soldering that do not need pinpoint-sharp beams.

The choice of laser depends on what wavelengths the material absorbs. Table 3-8 lists absorptions of selected materials at three key wavelengths: the green second harmonic of neodymium or ytterbium fiber lasers, the near-infrared fundamental line of neodymium or ytterbium, and the 10.6 μm line of CO₂ lasers. Note that copper absorbs much more strongly in the green range than at other wavelengths, making doubled Nd or Yb lasers particularly attractive. White paint, on the other hand, absorbs the CO₂ line very strongly.

Table 3-8. Surface Absorption at Important Laser Wavelengths

Material or laser	Doubled Nd or Yb	Nd or Yb	CO₂
Wavelength	515-532 nm	1030 or 1064 nm	10.6 μm
Aluminum	9%	8%	1.9%
Copper	56%	10%	1.5%
Iron	68%	~35%	3.5%
Nickel	40%	26%	3%
Titanium	48%	42%	8%
White paint	30%	10%	90%

Plastics typically have high absorption in the mid-infrared range, well beyond 1 μm but not out to 10 μm , so lower-power lasers emitting at 1.8 to 4 μm are used to cut and weld plastic.

Power requirements vary widely with the application. A few watts may suffice to cut thin plastics, but thick sheets of metal may require kilowatts. Repetitive pulses are better than high-power continuous beams for drilling and some other applications. Very short pulses, in the picosecond to femtosecond range, are used for precise machining of small areas or sensitive materials, because the pulses are so short that they ablate the surface layer without delivering enough heat to damage the substrate.

High-power materials working lasers require expensive space on the factory floor, so their size is a concern. Fiber lasers generally are the most compact per watt: a multikilowatt model is about the same size as a home refrigerator. High-power lasers generally draw heavy currents at high voltage and may require active cooling by internal

fans or flowing water. Overall efficiency of CO₂, diode-pumped Nd or Yb-fiber lasers are in the 10% to 35% range; fiber lasers are the most efficient. Diode lasers can be up to 50% efficient, making them attractive for heat treating. Costs are competitive and have come down with the development of high-power fiber lasers.

For more details on how lasers are used in materials working, go to The National Center for Optics and Photonics Education (OP-TEC) website (www.op-tec.org) and download copies of the Photonics-Enabled Technologies (PET) series publications entitled *Laser Welding and Surface Treatment* and *Laser Material Removal: Drilling, Cutting, and Marking*. Other PET series modules that are related to materials working include *Lasers in Testing and Measurement: Alignment, Profiling, and Position Sensing* and *Lasers in Testing and Measurement: Interferometric Methods and Nondestructive Testing*.

Lasers for Semiconductor Photolithography

Fabrication of semiconductor chips depends on photolithography, which writes patterns on a light-sensitive coating that is etched away during chip manufacture. The size of these features depends on the illuminating wavelength; state-of-the-art chips need light in the deep to extreme ultraviolet range.

Laser Functions in Semiconductor Photolithography

Photolithography masks contain patterns that must be etched onto chip surfaces. Laser light projects the image of the mask onto the surface to fabricate features just a few tens of nanometers across. Thanks to some ingenious optical tricks, the wavelength does not have to be as small as the features, but the ultraviolet pulses must be bright enough to write the required patterns.

Laser Types Used for Semiconductor Photolithography

The two excimer lasers now used in semiconductor photolithography are KrF at 248 nm and ArF at 193 nm. The KrF line is used to make chips with minimum feature sizes of 0.25 to 0.15 μm . The shorter ArF wavelength was introduced in the early 2000s to make smaller chip features and is now making chips with 32 nm features. Average powers required for photolithography are tens of watts.

The excimer lasers used in photolithography are built into chip-production systems, which operate in clean rooms. The systems include the laser, steppers that move chips during production, etching equipment, and machinery for doping the semiconductor wafer and slicing a wafer into chips. The least expensive of these systems cost well over half a million dollars, and sophisticated hardware can run into the tens of millions of dollars.

The optical tricks that allow ultraviolet light to write features less than one-fifth of its wavelength are largely exhausted, and planners want to shift to extreme ultraviolet (EUV) sources emitting at 13.5 nm. The EUV sources have been demonstrated and are now being tested, but they have yet to reach the power levels needed for mass production. A leading candidate has fired 10.6 μm CO₂ laser pulses at tiny droplets of tin to make them emit intense EUV light at 13.5 nm. Laser equipment manufacturers are currently developing plans to develop a CO₂ laser with an average power of 31 kW that could produce 125 W of EUV power. (Higher powers are required in the EUV because of higher optical loss than at ArF wavelengths.)

Measurement Applications and Remote Sensing

Lasers perform a wide variety of measurements. Some are quite simple, such as drawing a laser line to align walls at a construction site or making radar-like measurements of distance. Others are more complex, such as identifying the spectra of chemicals at a distance. We can't cover them all in this module, but we can describe the basic concepts.

Low-power visible red or green laser beams can draw lines through the air to help align machinery, equipment, and structures during construction and surveying. Pulsed laser radars can be used to measure distance and velocity. Police use them for clocking speeding motorists. Soldiers use them as range finders to measure the distance to a potential target. Laser beams help civilian surveyors measure angles, and they guide smart bombs to military targets.

Remote sensing uses lasers and sometimes other light sources to identify chemicals by measuring the wavelengths of light that the materials emit, absorb, or reflect. For example, a laser beam could illuminate the plume from a distant smokestack, and a sensor attached to a telescope could examine the reflected light to see if a particular pollutant was absorbing light at a characteristic wavelength. The presence of a dark line at the proper wavelength would indicate that the pollutant was present, and the amount of light absorbed at that wavelength would measure the concentration or amount of the pollutant. In a laboratory or factory, similar laser techniques can measure the properties of nearby materials.

Laser Functions in Measurement and Remote Sensing

Lasers used in construction alignment draw a line through space that becomes visible when an object interrupts the beam. For example, a rotating mirror or prism can sweep a laser beam in a level plane around a room to show construction workers where to place mounts for a dropped ceiling. Similarly, surveyors use a laser beam to measure and define angles.

Laser radars fire short pulses at objects and time how long the light takes to return to a detector. If a laser pulse took one microsecond to return from a target, the round-trip distance would be 300 m (the distance light travels in a millionth of a second), and the object would be 150 m away. Police officers' laser radars measure speed by firing a series of short pulses, measuring the car's distance for each one, then calculating how far the car moved between pulses to determine its speed.

Remote sensing uses the laser beam as a probe source. For example, a tunable laser could sweep its wavelength range 1000 times a second as it points at a distant tree, and a sensor could measure the reflected light a million times a second, or 1000 times during each scan. If the laser scanned uniformly across its wavelength range, the time at which the sensor detected a drop in light would tell the wavelength that absorbed light.

Laser Wavelength, Power, Pulses, and Operation

Laser surveying and alignment instruments generally require low-power beams of visible light because people must see them. The beams normally are continuous, and the laser must be able to operate outdoors from batteries. Typically, these instruments use red diode lasers or low-power frequency doubled neodymium lasers emitting at 532 nm. Laser radars usually emit at near-infrared wavelengths longer than 1400 nm, which are

absorbed in the ocular fluid and so do not reach the retina and endanger bystanders. Pulse duration limits the accuracy of distance measurements to the distance light travels in one pulse, so a 10 ns pulse yields results accurate to 1.5 m, half the round-trip distance that light travels in 10 ns.

The wavelengths and lasers chosen for remote sensing depend on the material being studied. Molecules have characteristic absorption lines in the mid-infrared range, so much remote sensing is done in that range.

For more details on how lasers are used in remote sensing, go to The National Center for Optics and Photonics Education (OP-TEC) website (www.op-tec.org) and download copies of the Photonics-Enabled Technologies (PET) series publications entitled *Spectroscopy and Remote Sensing* and *Spectroscopy and Pollution Monitoring*.

Laser Medical Treatment

Lasers are used in two broad classes of medical treatment, depending on power level.

1. Low-power lasers, often visible diode lasers, are used for “cold laser therapy,” in which joints or nerves are illuminated to ease pain from arthritis and other conditions. Similarly, low-power lasers can be used to illuminate acupuncture points in laser acupuncture. Both techniques are controversial.
2. Higher-power lasers are used for several types of medical treatment.

CO₂ lasers at power levels of watts are used to cut tissue and to remove blood-rich tissue from sensitive areas, such as the female reproductive tract. Water strongly absorbs the 10.6 μm CO₂ line, so the laser cauterizes as it cuts, reducing bleeding. Lower-power CO₂ lasers are used to remove wrinkles and resurface the skin.

Pulses from argon-fluoride excimer lasers can ablate tissue quickly and cleanly, without damage to adjacent tissue, so they are used in refractive surgery, which reshapes the cornea to correct vision.

Continuous wave green and yellow lasers can destroy abnormal blood vessels on the retina arising from diabetes and wet-form macular degeneration. The 577 nm yellow wavelength of optically pumped semiconductor lasers (OPSLs) was developed because it is strongly absorbed by oxygenated hemoglobin in blood vessels. The 532 nm wavelength of doubled neodymium and other lasers also is strongly absorbed by blood. Watt-class power is required. Yellow OPSLs can also bleach pigmented lesions called portwine stains by destroying the abnormal blood vessels that color them.

Lasers are also used to treat skin conditions. Q-switched alexandrite and ruby lasers can remove some tattoos by breaking down the inks used. Xenon-chloride lasers emitting at 308 nm are being developed for the treatment of psoriasis, a chronic skin disease with no known cure. The new technique illuminates the affected area for one to 15 minutes, depending on its severity.

Near-infrared laser pulses, typically from diodes, are used in “laser razors,” which remove hair by killing hair follicles. The process’s success depends on concentrating light absorption in the follicles and avoiding excess skin absorption, so it works best for people with dark hair and light skin. Home laser razors generally are intended for use only below the neck, to prevent accidental eye damage.

Medical Diagnostics and Measurements

Low-power lasers are widely used in medical diagnoses and measurement.

Many techniques require laser light to make sensitive measurements. In flow cytometry, cells are tagged with a dye that selectively bonds to part of the cell. The tagged cells are then illuminated with a blue or green laser to excite fluorescence. The signal strength indicates the number of cells selected, so by measuring signal strength, we can get accurate cell counts. Originally, argon lasers illuminated samples at 488 nm, but now, solid state OPSLs are used at that wavelength. Additionally, red laser light is routinely used to measure the degree of blood oxygenation: doctors shine the light through a patient's fingertip to spot oxygenated hemoglobin.

For more details on how lasers are used in medicine, go to The National Center for Optics and Photonics Education (OP-TEC) website (www.op-tec.org) and download copies of the Photonics-Enabled Technologies (PET) series publications entitled *Lasers in Medicine and Surgery*, *Therapeutic Applications of Lasers*, and *Diagnostic Applications of Lasers*.

Lasers for Research and Laboratory Measurement

Tunable lasers have become an invaluable tool in spectroscopy, the study of the wavelengths emitted or absorbed by materials. Spectroscopy can reveal materials' composition and behavior and can be combined with ingenious optical tricks to measure very fine details of atomic and molecular behavior. Titanium-sapphire, quantum cascade, and tunable dye lasers are used, as are other tunable sources such as optical parametric oscillators and amplifiers. Limited tuning ranges are acceptable for many applications.

Lasers also can generate ultrashort pulses lasting a few femtoseconds for research on very fast events such as chemical reactions, and research on generating ultrashort pulses is thriving. Trains of ultrafast pulses can generate frequency combs, a series of frequencies equally spaced across a range of the spectrum at very precise frequencies. The starting point for much of this research is the titanium-sapphire laser, although erbium-doped fiber lasers can also generate femtosecond pulses.

Laser beams also can trap and manipulate tiny objects such as living cells; these lasers have earned the name "optical tweezers." Lasers can slow down atoms, effectively cooling their temperatures dramatically. This technique, called laser cooling, is achieved by tuning the laser so that atoms have to slow down a little bit as they absorb the light and re-emit it.

For more details on how lasers are used in laboratory measurements, go to The National Center for Optics and Photonics Education (OP-TEC) website (www.op-tec.org) and download a copy of the Photonics-Enabled Technologies (PET) series publication entitled, *Basics of Spectroscopy*.

Laser Reading, Scanning, Writing, Projection, and Holography

Laser beams can read, record, write, and display information in many forms. Most use only low power.

The best-known use of lasers to read information is the playing of optical disk recordings of music, computer data, and video. Billions of diode lasers have been made for these applications, and the scale of production has made the lasers very inexpensive. Near-infrared GaAlAs diodes

emitting at 780 nm are used to read and play audio compact disks. 670-nm GaInP diode lasers play video on DVDs. GaInN lasers emitting at 405 nm play Blu-ray high-resolution video disks. Diode lasers also can store audio, data, or video information on recordable versions of these disks.

Red diode lasers read bar codes on product packages. The first generation of laser scanners using helium-neon lasers became common for supermarket checkout in the early 1980s. Barcode scanners based on red diode lasers are now widely used in retail.

Diode lasers write on laser printers as well as on optical disks. They scan across the same sort of electrostatic drum used in a photocopier, writing tiny spots that combine to spell out text or display images, which the toner on the drum then transfers to paper. Simple laser printers write in black and white on a single drum that uses black toner, and writing on drums with cyan, magenta, yellow, and black toner can produce color images.

When particularly bright images are needed, lasers can display them on screens, walls, or even clouds. A combination of red, green, and blue lasers can produce full-color images.

The coherence of laser light is essential for recording holograms. The beam is divided by passing it through a beam splitter, with one half illuminating an object and the other following a separate path until the two halves combine to record a hologram on film or an image sensor. Illuminating the hologram with a laser at the proper angle recreates the wavefront that would have come from the object, so we see an image that looks three-dimensional.

For more details on how lasers are used to store data and create holograms, go to The National Center for Optics and Photonics Education (OP-TEC) website (www.op-tec.org) and download copies of the Photonics-Enabled Technologies (PET) series publications entitled *Photonics Devices for Imaging, Storage, and Display* and *Basic Principles and Applications of Holography*.

Military Lasers

As already mentioned, solid state lasers firing pulses that last nanoseconds, are used as rangefinders and find applications in the military for targeting enemy assets. Similar lasers illuminate military targets with a coded series of infrared pulses to mark them as targets for smart bombs, which home in on the coded spot.

Frequency doubled neodymium lasers emitting hundreds of milliwatts are used like bright searchlight beams to dazzle the eyes of potentially hostile people at military checkpoints. The laser system spreads the beam out to avoid eye injury but still cause temporary vision impairment. This forces the hostile person to look away from the light source, which makes it hard for him or her to shoot at the source. The Pentagon considers laser dazzlers nonlethal weapons because their bright beam can deter attacks by insurgents or pirates without killing them.

Laser weapons emitting more than 100 kW are in development for destroying rockets, artillery, and mortar shells at distances up to a few kilometers. A fire-control system detects and tracks the target and aims the laser beam at it. Light from the laser heats the target, causing it to explode in the air far from its target. Such weapons are not yet deployed, but both fiber lasers and neodymium solid state lasers have achieved 100 kW continuous power, and efforts are in progress to militarize them.

Lasers for Adaptive Telescope Optics

Another high-profile laser application is laser guide stars for adaptive optic systems on large telescopes. Stars twinkle in ground-based telescopes because turbulence in the air refracts starlight randomly, causing a star's apparent position to jiggle. Optical engineers developed adaptive optic systems with flexible surfaces that bend to compensate for this turbulence, but these systems require a tool for measuring the degree of turbulence. To provide that measurement, astronomers aim a pulsed laser tuned to emit at 589.2 nm to excite sodium vapor high in the atmosphere, producing a "laser guide star" that measures the turbulence in the air. Figure 3-40 shows a yellow laser beam used at the Keck-2 telescope on Mauna Kea, Hawaii. So far, tunable dye lasers have been used, but other types are being explored.



Figure 3-40 *Laser guide star from the Keck-2 telescope on Mauna Kea, Hawaii. The stars moved noticeably during the three-minute exposure needed to record the laser beam.*

Future Laser Applications

The range of laser applications has increased greatly over the years, but research and development continues on new applications for future use. Some concepts have been in development for many decades, but others are quite new. Here, we look at a sampling of them to see what challenges laser technology faces and what new capabilities it could offer in the future.

Long-Term Projects and Big Challenges

The laser has stimulated thinking on how we can use a powerful beam of coherent light to enhance existing technologies, processes, and products. Early proposals went far beyond pointing, measurement, local communications, and materials working. Visionaries saw the

potential for lasers that could transmit power, trigger nuclear fusion, destroy nuclear-tipped missiles, and control chemical reactions. But in many cases, the goals were far harder to achieve than they appeared half a century ago.

Laser Weapons

It's easy to zap a target with a laser beam. It's a lot harder to deliver enough laser energy to the target to do lethal damage. Defense against nuclear missiles was a pressing issue half a century ago, and it remains difficult today. Military planners believed that a weapon able to strike at the speed of light would provide a decided advantage in any conflict.

However, getting a powerful laser beam through the air is not as easy as it looks. The air absorbs a small fraction of the beam, heating it slightly, so it defocuses the beam. Air turbulence bends and distorts the beam. The higher the power, the worse the problems get. Moreover, megawatt lasers proved to be massively complex, gigantic, and extremely costly. Crammed into the interior of a Boeing 747, the multibillion-dollar Airborne Laser fell far short of the 200 km lethal range that the Air Force wanted.

A new and more promising alternative is using 50 to 100 kW class fiber or solid state lasers to stop attacks by rockets, artillery, and mortars. Typically, the targets are only a kilometer or two from the laser, and they can be "killed" by igniting the explosive. The reduced distance substantially diminishes the power required to destroy these targets. Powered by a diesel generator, the lasers are compact enough to be mounted on a mobile platform. It's an application within the reach of current technology and an important one for fighting insurgents.

Energy from Laser Fusion

Nuclear fusion reactors have offered the allure of clean and nearly limitless energy for more than half a century, but progress has been agonizingly slow. In theory, intense laser pulses could be focused onto a sphere of deuterium-tritium fuel to heat and compress it to the extreme conditions needed for nuclear fusion. In practice, this has proved to be extremely difficult.

In 1972, physicists predicted that one kilojoule of laser energy would suffice to produce the fusion energy necessary to generate the laser pulse, i.e. break even. A series of bigger lasers have been built over the past 40 years. The latest, the National Ignition Facility, is the world's largest laser, able to generate pulses of 1.8 MJ, but it still failed to ignite a fusion plasma, although it has simulated the explosion of thermonuclear weapons for the Pentagon.

Laser fusion energy remains a dream, but specialists are trying to refine their understanding of fusion implosions to help them develop laser fusion reactors.

Laser Uranium Enrichment and Selective Photochemistry

The laser's ability to generate light at a very narrow range of wavelengths has long appealed to chemists, because such pure light could let them selectively excite different isotopes to prepare isotopically pure materials. The biggest interest has long been in picking the relatively few atoms of fissionable uranium-235 from the far more abundant nonfissionable U-238. Decades of research have shown that lasers can selectively excite U-235 in both uranium vapor and molecules of uranium hexafluoride. However, the separation between these isotopes does not last long enough for the chemists to retrieve the one they want.

Now, a new twist on the process may have solved that problem: the people at Global Laser Enrichment claim that they can retrieve U-235 from "tailings" left over from older non-laser processes. We'll have to wait and see whether they are successful.

New Laser Research Tools

New laser technology is being developed for use as tools in advanced research, and the list of possibilities keeps growing. There is no room to cover all the proposals, but some of the most exciting research includes:

- Generation of pulses with duration measured in attoseconds (10^{-18} s), to study extremely fast events.
- Generation of ultrashort pulses with extremely high peak power of an exawatt (10^{18} W) with the Extreme Light Infrastructure, to see how matter behaves under such extreme conditions.
- Generating frequency combs, a series of equally spaced optical frequencies locked together, which could measure frequencies so precisely that they could spot Earth-sized planets orbiting other stars or help communication engineers send more information through optical fibers.
- Compact tabletop laser accelerators to boost subatomic particles to extremely high velocity for research, replacing massive particle accelerators.
- Laser and laser-like sources of entangled particles for quantum encryption.
- Laser micromanipulation and nanosurgery, which would allow biomedical researchers to study the effects of removing tiny structures from living cells.

Some of these new research tools will go on to find practical applications. For example, precision frequency measurements could lead to more precise time measurement and to optical clocks that could be installed in a new generation of GPS satellites to improve the precision of their location data. Frequency combs might be used to transmit information at even higher speeds than in current fiber-optic systems. Entangled photons could be used for secure communications. Laser nanosurgery might be adapted to alter living cells so that doctors could replace damaged or cancerous tissue. As you learn more about lasers, you will be able to think of other potential applications.

Summary

This module has presented a broad overview of the different types of lasers that are currently available and their applications. Most of the information presented in this module concerning laser types is summarized in Tables 3-9, 3-10 and 3-11. To make the tables a good reference for your future use in other courses or the workplace, we have also included lasers that are currently in use but that are not explicitly mentioned in the module.

Table 3-9. Lasers By Active Gain Medium & Excitation

Active Gain Medium	Laser Type	Specific Laser	Excitation Mechanism
Gas Lasers			
	Neutral Atom	Helium Neon	Electrical Discharge
	Ion	Argon	Electrical Discharge
		Krypton	Electrical Discharge
	Metal Vapor	Helium Cadmium	Electrical Discharge
		Neutral (Copper & Gold Vapor)	Electrical Discharge
	Molecular	CO ₂	Electrical Discharge
		CO	Electrical Discharge
		HF/DF	Chemical Reaction/Electrical Discharge
		Nitrogen	Electrical Discharge
	Excimer		Electrical Discharge
Solid State			
	Ruby		Lamp Pumped
	Neodymium	Glass	Lamp or Diode Pumped
		YAG (Yttrium Aluminum Garnet)	Lamp or Diode Pumped
		YLF (Yttrium Lithium Fluoride)	Lamp or Diode Pumped
		YVO ₄ (Yttrium Vanadate)	Lamp or Diode Pumped
	Erbium Doped	Fiber	Diode Pumped
		YAG	Lamp or Diode Pumped
	Lamp or Diode Pumped		Diode Pumped
	Vibronic	Ti-Sapphire	Laser Pumped (doubled Nd)
		Alexandrite	Lamp Pumped
Semiconductor Lasers			
	Edge-Emitting		Electrical
	Surface Emitting (VCSELs)		Electrical
	Quantum Cascade		Electrical
	OPSLs		Diode Pumped
Tunable Organic Dye (liquid) Lasers			
	Rhodamine 6G		Laser Pumped
	Coumarin		Laser Pumped
	Fluoracine		Laser Pumped
Free Electron Lasers			Electron Beam

Table 3-10. Lasers by Wavelength

Lasing Medium	Laser Type	Wavelength
FAR-INFRARED		
CO ₂	Gas	9–11 μm
CO	Gas	5–6 μm
Quantum cascade	Semiconductor (non-diode)	4–12 μm
DF	Gas (chemical)	3.5–4.0 μm
HF	Gas (chemical)	2.6–3.0 μm
Cr:ZnSe / Cr:ZnS	Solid State	2.0–3.3 μm
NEAR-INFRARED		
Thulium	Fiber	1900–2050 nm
Antimonide Diodes	Semiconductor Diode	1.8–2.4 μm
Er:Glass	Solid State or Fiber	1530–1570 nm
Iodine (COIL)	Gas (chemical)	1315 nm
InGaAsP	Semiconductor Diode	1150–1650 nm
Cr:Forsterite	Solid State	1150–1350 nm
HeNe	Gas	1152 nm
Argon	Gas–Ion	1090 nm
Nd:YAP	Solid State	1080 nm
Nd:YAG, Nd:YVO ₄	Solid State	1064 nm
Nd:Glass	Solid State	1060 nm
Nd:YLF	Solid State	1053 nm
Nd:YLF	Solid State	1047 nm
Yb:glass	Fiber or Solid State	1030–1080 nm
InGaAs	Semiconductor	915–980 nm
GaAs	Semiconductor	905 nm
Krypton	Gas–Ion	799.3 nm
Cr:LiSAF	Solid State	780–1060 nm
GaAs/GaAlAs	Semiconductor	780–905 nm
Krypton	Gas–Ion	752.5 nm
Alexandrite (Cr)	Solid State	701–826 nm
Ti:Sapphire	Solid State	700–1000 nm
VISIBLE		
Ruby	Solid State	694 nm
Krypton	Gas–Ion	676.4 nm
GaAsP	Semiconductor	670 nm
Krypton	Gas–Ion	647.1 nm
InGaAlP	Semiconductor	635–660 nm
HeNe	Gas	633 nm
HeNe	Gas	612 nm

HeNe	Gas	594 nm
Cu	Metal Vapor	578 nm
Krypton	Gas-Ion	568.2 nm
HeNe	Gas	543 nm
Doubled Nd	Solid State	532 nm
Krypton	Gas-Ion	530.9 nm
Doubled Yb	Fiber	515 nm
Argon	Gas-Ion	514.5 nm
Cu	Metal Vapor	511 nm
Argon	Gas-Ion	501.7 nm
Argon	Gas-Ion	496.5 nm
Argon	Gas-Ion	488.0 nm
Argon	Gas-Ion	476.5 nm
Argon	Gas-Ion	457.9 nm
HeCd	Gas-Ion	442 nm
N ₂ ⁺	Gas	428 nm
Krypton	Gas-Ion	416 nm
InGaN	Semiconductor	375–525 nm
Organic dye	Liquid	320–1000 nm
NEAR-ULTRAVIOLET		
Argon	Gas-Ion	364 nm (UV-A)
Tripled Nd	Solid State	355 nm (UV-A)
XeF	Gas (excimer)	351 nm (UV-A)
N ₂	Gas	337 nm (UV-A)
HeCd	Gas-Ion	325 nm
XeCl	Gas (excimer)	308 nm (UV-B)
FAR-ULTRAVIOLET		
Krypton SHG	Gas-Ion/BBO crystal	284 nm (UV-B)
Ar ⁺²	Gas-Ion	275–305 nm (UV-B) (multiple lines)
Quadrupled Nd	Solid State/Harmonic	266 nm (UV-C)
Argon SHG	Gas-Ion/BBO Crystal	264 nm (UV-C)
Argon SHG	Gas-Ion/BBO Crystal	257 nm (UV-C)
Argon SHG	Gas-Ion/BBO Crystal	250 nm (UV-C)
Argon SHG	Gas-Ion/BBO Crystal	248 nm (UV-C)
KrF	Gas (excimer)	248 nm (UV-C)
Argon SHG	Gas-Ion/BBO Crystal	244 nm (UV-C)
Argon SHG	Gas-Ion/BBO Crystal	238 nm (UV-C)
ArF	Gas (excimer)	193 nm (UV-C)
F ₂	Gas (excimer)	157 nm (UV-C)

Table 3-11. Laser Applications

Technology Area	Laser Type	Wavelength	Application
Communications & IT			
	GaAlN Diode	405 nm	Blu-Ray Disc Player
	GaAsP Diode	670 nm	DVD Player
	.		
	.		
	.		
Cosmetic Treatment			
	GaAlAs Diode	810 nm	Laser hair removal
	CO ₂	10.6 μm	Wrinkle removal, skin resurfacing
Entertainment & Display			
	Violet Diode (GaAlN)	405 nm	Laser pointers, DVD players
	Blue Diode	445 nm	Displays, blue pointers
	Argon Ion	514.5 nm	Laser light shows
	Mixed-Gas Ar-Kr	488–647 nm	Laser light shows and displays
	Doubled Nd	532 nm	Green laser pointers, holography
	InGaAlP Diode	635 nm	Red laser pointers
	Helium-Neon	633 nm	Holography
LIDAR & Remote Sensing			
	Pulsed Neodymium	1064 nm	Target ranging, laser radar
	Pulsed Erbium	1555 nm	Target ranging, laser radar, remote sensing (retina safe)
	Thulium	1900–2050 nm	Target ranging, laser radar, remote sensing (retina safe)
	Quantum Cascade	4–12 μm	Remote sensing of gases in atmosphere, pollutants, toxins (tunable)
Materials Processing			
	CO ₂	10.6 μm	Heat treating, welding, cutting metals or nonmetals, selective laser sintering
	Neodymium Bulk	1.064 μm	Cutting, welding, soldering, drilling, marking, scribing, mostly metals
	Ytterbium Fiber	1.03–1.08 μm	Cutting, welding, soldering, marking
	Nd/Yb Fiber	515–532 nm	Cutting and welding copper
	Thulium Fiber	1900–2050 nm	Cutting and welding plastics
	Antimonide Diodes	1850–2000 nm	Welding plastics, heat treating
	Ultrashort-Pulse Nd	1064 nm	Precision machining glass, ceramics
Measurement and Alignment			
	Helium–Neon gas	632.8 nm	Surveying equipment
	Red Diode	635–660 nm	Surveying equipment, construction alignment

Medical Diagnosis and Imaging			
	Visible Diode	635 nm	Patient alignment in medical instruments
Medical Treatment			
	CO ₂	10.6 μm	Soft tissue surgery, self-cauterizing, wrinkle removal, cosmetic skin treatment
	ArF Excimer	193 nm	Refractive eye surgery (LASIK)
	InGaAlP, GaAsP	635–670 nm	Laser acupuncture, pain relief
	Alexandrite	701–826 nm	Tattoo removal
	Ruby	694 nm	Tattoo removal
	Yellow OPSLs	577 nm	Bleaching port-wine stains on skin, photocoagulation in retina for diabetic retinopathy, wet-form macular degeneration
	Doubled Nd:YAG	532 nm	Photocoagulation in eye surgery
Military and Police			
	Doubled Nd:YAG	532 nm	Laser dazzlers to deter attacks, laser gun sights
	InGaAlP	653–670 nm	Laser gun sights
	Nd:YAG	1064 nm	Rangefinders, target designators
	Erbium–Glass	1550 nm	Retina-safe rangefinders, target designators
	High-Power Yb Fiber	1030 nm	Laser defense against rockets, artillery, missiles
	High-Power Nd:YAG	1064 nm	Laser defense against rockets, artillery, missiles
Semiconductor Manufacture			
	ArF Excimer	193 nm	Photolithography
	KrF Excimer	249 nm	Photolithography
	Neodymium Pulsed	1064 nm	Scribing semiconductors, trimming resistors
Tunable and Spectroscopic Laser			
	Argon	364 nm	Fluorescence spectroscopy and measurement
	Dye	300–1000 nm	
	Erbium Fiber	1530–1580 nm	
	GaInN Diode	405 or 442 nm	
	Helium–Cadmium	442 nm	
	Tripled Nd	355 nm	
	OPSLs	442 nm	
	Quantum Cascade	4–12 μm	
	Sapphire	700–1000 nm	Spectroscopy and measurement; ultrafast pulses
	Ytterbium Fiber	1015–1100 nm	Ultrashort pulse generation

TROUBLESHOOTING

This module has exposed you to a wide variety of laser types and their applications. In our description of these types, we have described their optimum operating characteristics. For these lasers to meet these optimum specifications, they must be properly maintained. A key to maintaining lasers (and most technology-based systems) is monitoring the input and output of their subsystems to ensure that they meet the original equipment manufacturers (OEM's) specifications. When these specifications are not met, technicians responsible for these laser systems must use troubleshooting techniques to determine the cause of the laser being “out of spec” or malfunctioning.

In this section, we describe basic laser-maintenance procedures and then provide information on troubleshooting strategies that are effective at isolating problems often found in laser systems. Subsequent modules about specific types of lasers will provide additional troubleshooting information that is unique to the particular laser discussed in that module.

Maintenance of Lasers

The efficient and safe operation of lasers requires that one or more workers be assigned to maintain the work area and equipment. Specifically, these assignments include the following:

- All equipment and maintenance manuals provided by the manufacturer should be obtained and kept in a file that is available to the staff.
- Supplies and spare parts for all equipment should be secured, labeled, and stored appropriately.
- Components, such as lenses, filters, prisms, and optical supports, should be labeled (focal length, diameter, material, etc.) and stored in a clean and organized manner.
- Lenses, mirrors, prisms, filters, and other optical or electro-optical components should be checked periodically to ensure that they are clean and show no apparent defects or deterioration.
- Laboratories or work stations must be well organized to assure safe mobility when lighting is reduced or eliminated during optical alignments.
- Appropriate safeguards for the facility should be ensured to prevent electrical shock, chemical contamination, and eye damage. Specific laser safety goggles should be available—and used when needed.

Troubleshooting Laser and Other Equipment Malfunctions

Performance of equipment according to specifications is essential for successful work and personnel safety. Most equipment in laser facilities consists of some combination of electrical, electronic, optical, and laser systems. Diagnostic techniques and procedures for measuring equipment performance are available in electronics courses and in Module 2-2 of this course, *Laser Output Characteristics*. When equipment is not operating according to specifications, it is the responsibility of the laser technician to determine the cause of the malfunction and take steps to correct it.

Electrical and Electronic Problems in Lasers

Well-developed education and training materials for troubleshooting electrical and electronics systems are available. Typically, the photonics technician student has completed a course in electronics troubleshooting before studying laser systems and applications. In addition to peripheral electronic and electrical equipment in the laser facility, laser equipment also includes the following electrical and electronic devices:

- Power supplies and capacitor discharge circuits
- Equipment interlocks
- Amplifiers and control devices
- Optical and laser detectors, power meters, and controllers
- Diagnostic and monitoring equipment

If a laser system is malfunctioning, the first approach to troubleshooting should be to examine the electrical and electronic devices contained within it. Typical electrical problems in laser systems include:

- Interlock problems
- Visually observed, burned out components and wiring, or evidence of overheating and insulation deterioration.
- Overvoltage or under-voltage problems

Typical electronic problems in laser systems include:

- Burned-out or overheated components and circuit boards
- Water or moisture damage
- Electrostatic discharge (ESD) problems

If the laser has a cooling system, coolant flow rate or fan cooling should also be examined.

Optics Problems

If the electrical and electronic subsystems of a laser appear to be operating normally, the next step should be to visually examine the optical components (lenses, mirrors, prisms, beam splitters, etc.) external and internal to the laser. Some problems to look for are:

- Pitted, scratched, missing, or dirty optics; overheated optics that cause cracks; or damaged mirror coatings
- Mounting problems that misalign or loosely support the optical elements, causing them to be intermittently misaligned
- Misalignment of the optical axis or the optical resonator cavity

Output Beam Problems

- Low output beam energy or power
- Temporal characteristics
 - Incorrect pulse shape or duration

- Incorrect pulse repetition frequency
- Flickering (intermittent temporal variations)
- Spatial characteristics
 - Improper beam divergence
 - Poor beam quality (mode quality)
 - Incorrect beam profile
- Spectral characteristics
 - Wrong output wavelength
 - Improper bandwidth

What Does Troubleshooting Require?

In some cases of laser malfunctions, the technician at the worksite may be able to diagnose the problem and repair it. This is particularly true for electrical and electronic problems. It can also be true for optical component damage or misalignments. In many cases, it may be necessary to contact the manufacturer of the laser equipment to obtain advice or technical support. Before doing this, prepare careful notes of the diagnostic attempt and be prepared to communicate them to the manufacturer's representative.

The following steps outline a procedure for troubleshooting most laser systems:

1. Identify and classify the malfunction. Perform a detailed visual inspection.
2. Define the status of the defective laser by understanding what is working and what is not working.
3. Check the electrical and electronics subsystems first.
4. Ensure that the optics are clean and not damaged.
5. Measure the malfunction.
6. Attempt to determine when the failure occurred and what may have caused the failure.
7. Is the problem intermittent?
8. Is the problem temperature dependent?
9. If possible, replace defective components.
10. Work with the laser manufacturer in the following ways:
 - a) Obtain and study manufacturer's maintenance manuals.
 - b) Communicate with the manufacturer's representative about the nature of the problem and the things you have done to understand the problem and correct it.
 - c) Receive and replace a subunit provided by the manufacturer.
 - d) Allow the manufacturer to correct the problem, either by using a field representative or by sending the equipment back to the manufacturer.

WORKPLACE SCENARIO

Here is your opportunity to use the concepts you have learned in this module to solve an actual problem that could arise in a photonics company. Your instructor will provide directions for developing a solution.

Selecting a Laser to Cut Stainless Steel

Scenario

You are a senior technician working in a technical team for a manufacturing organization that prepares and assembles parts made from sheet metal. The lead engineer has informed you that the plant will need to acquire a laser to cut ½-inch stainless steel to produce parts for a new device that will be manufactured. You have been assigned the following tasks:

- Find the appropriate laser types that can be used for this operation.
- Outline the advantages and disadvantages of at least three laser types that should be considered for this operation.
- Select the optimum laser type. Provide your rationale for this selection.
- Identify at least three companies that sell this type of laser processing equipment.
- Prepare the specifications to enable solicitation of bids from appropriate laser equipment suppliers.
- Select one laser system for your company to purchase. Explain why you made this choice.

Additional Information

You can find the information you need to solve this problem from at least three sources:

1. Descriptions of the different types of lasers and their applications can be found in this module. Particularly useful information is in Tables 3-9, 3-10, and 3-11.
2. Download the OP-TEC Photonics-Enabled Technologies (PET) module entitled *Laser Material Removal: Drilling, Cutting, and Marking*.
3. Search the Internet sites of laser equipment manufacturers. A detailed search of these sites will reveal the following information about specific models of laser cutting equipment.
 - a) System operating (output) parameters of power, PRF, wavelength, cutting speed vs. material type, and thickness
 - b) System specifications
 - c) Performance
 - d) Operating/Maintenance Manuals

- e) Contact information for the manufacturer's representative, who can clarify statements from the website and answer questions about specific performance parameters.

Data Collection

1. Use the chart of laser types and applications to select 3 types of lasers for cutting systems.
2. Identify manufacturers of laser cutting equipment and search their internet sites for equipment that is appropriate for this application.
3. Prepare a data table to compare the operating requirements and performance parameters for the laser cutting equipment that you found.

Problem and Tasking

1. Select one type of laser that would be most appropriate for the desired application. Provide your rationale for this selection in a report. The report should include the tables you created in the Data Collection Section. Be prepared to justify your choice in a class discussion.
2. Examine the available manufactures and models of laser welding equipment and select (from the data chart you prepared) 2–3 suppliers and models of equipment that would be most appropriate for this application. Provide your rationale for these selections, based on the following criteria:
 - a) Performance
 - b) Speed
 - c) Versatility
 - d) Cost
 - e) Power consumption/facility requirements
3. If you cannot find all the information you need from the website, call or e-mail the customer service representative for help.

PROBLEM EXERCISES AND QUESTIONS

- Which of the following lasers are not considered “solid state” in laser terminology?
 - Ytterbium-doped fiber laser
 - Indium-gallium nitride semiconductor laser
 - Neodymium-doped glass laser
 - Ruby laser
 - Ceramic Nd:YAG laser
- Which of the following lasers cannot be electrically pumped, and why not?
 - Ruby solid state laser
 - Carbon dioxide gas laser
 - Quantum-cascade semiconductor laser
 - GaAlAs semiconductor diode laser
 - Argon-fluoride excimer gas laser
- It takes 21 eV to excite an atom of cadmium vapor to the upper level of the 442 nm transition of the helium–cadmium laser. Recalling that the energy of a photon E in electron volts is related to its wavelength (in micrometers) λ by the equation $E = \frac{1.2399}{\lambda}$, calculate what fraction of the excitation energy goes into the emitted photon.
- Which gas laser emits over the widest range of wavelengths in normal continuous wave operation?
 - Argon–fluoride excimer laser
 - Nitrogen laser
 - Red helium–neon laser
 - Carbon dioxide laser
 - Ruby laser
- You don’t have a flashlamp available, but you want to optically pump a ruby laser. Using the attached plot of the light absorption in ruby as a function of wavelength, pick a type of laser that you think would be most efficient and explain your choice.

RUBY, 0.03%Cr, Unpolarized

(uncorrected for Fresnel loss)

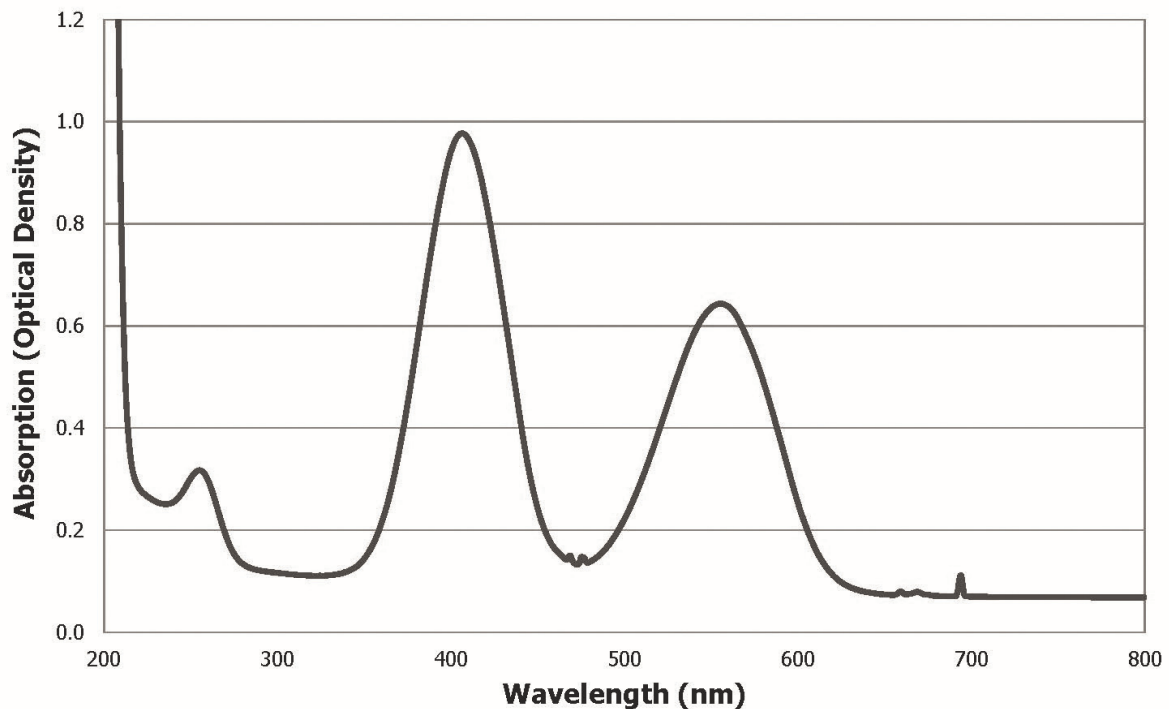

Northrop Grumman – SYNOPTICS / (704) 588-2340 / STSYNOPTICSSales@ngc.com

Figure 3-41 Ruby Crystal Absorption Data (Image Courtesy of Northrop Grumman Corporation)

6. Optical pumping deposits heat as well as light in a solid state laser, and that heat can build up when the laser is pumped at high power. What type of solid state laser is most likely to shatter from excessive heat when it is pumped at a high power level?
 - a) Slab geometry laser
 - b) Fiber laser
 - c) Thick laser rod
 - d) Thin laser rod
 - e) Thin-disk laser
7. What is the second harmonic wavelength of an ytterbium fiber laser emitting at the midpoint of its range of operating wavelengths?
 - a) 528 nm
 - b) 775 nm
 - c) 808 nm
 - d) 1055 nm
 - e) 3100 nm

8. You are selecting a laser that has the broadest operating bandwidth in the visible and near infrared range so that it can generate the shortest possible pulses. You should pick:
- Carbon dioxide laser
 - Neodymium-glass
 - Ytterbium-doped fiber
 - Titanium-doped sapphire
 - InGaAsP semiconductor diode laser

9. Which of the following materials does not make good semiconductor diode lasers?
- Silicon
 - Aluminum-gallium arsenide
 - Indium-gallium nitride
 - Gallium antimonide
 - AlGaInP/GaAs

10. Match the laser to the application

Laser	Application
A) Semiconductor photolithography	a) GaAlAs diode
B) Blu-ray disk player	b) GaInP/GaAs diode
C) DVD disk player	c) InGaN diode
D) Compact Disk audio player	d) InGaAsP diode
E) Fiber-optic communications	e) ArF excimer

11. How does a quantum-cascade laser differ from a diode laser?
- It is not made from a semiconductor
 - It has only electrons, rather than electrons and holes, as current carriers
 - Each electron generates more than one photon
 - a and b
 - b and c
12. You need a laser that emits at 4.5 μm . What type can you pick?
- Carbon dioxide
 - Quantum cascade
 - Deuterium fluoride
 - Antimonide diode
 - Cr:ZnSe

13. You are comparing lasers to make marks by ablating the surface layer from different materials. You have the choice between fundamental or second harmonic wavelengths of near-infrared solid state lasers, or carbon dioxide lasers. Your goal is to use the least possible energy. Assume that harmonic generation is 50% efficient, so you get only half as much energy at the second harmonic as at the fundamental. For which materials listed in Table 3-8 should you use a green laser? You may have more than one answer.
- a) Aluminum
 - b) Copper
 - c) Nickel
 - d) Titanium
 - e) White paint
14. High-power semiconductor lasers can generate up to kilowatts of power, but they do not generate a tightly focused beam. How might they best be used in laser materials working?
- a) Cutting
 - b) Drilling
 - c) Welding
 - d) Heat treating
 - e) Etching
15. A laser razor works by heating hair follicles to stop hair growth, so it needs to concentrate energy in the follicles rather than on the skin surface. Which combination of traits should people have to use a laser razor?
- a) Dark skin, dark hair
 - b) Dark skin, light hair
 - c) Light skin, dark hair
 - d) Light skin, light hair

REFERENCES

- Blaker, J. Warren, and Peter Schaeffer. 2000. *Optics: An Introduction for Technicians and Technologists*. Englewood Cliffs, NJ: Prentice-Hall.
- Hecht, Jeff. 2008. *Understanding Lasers: An Entry-Level Guide*. 3rd ed. Hoboken, NJ: IEEE Press/Wiley.
- Hitz, C. Breck, J. J. Ewing, and Jeff Hecht. 2012. *Introduction to Laser Technology*. 4th ed. Hoboken, NJ: IEEE Press/Wiley.
- Saleh, Bahaa E. A., and M. C. Teich. 2007. *Fundamentals of Photonics*. 2nd ed. Hoboken, NJ: Wiley.
- Svelto, Orazio. 2010. *Principles of Lasers*. 5th ed. New York: Springer.

INDEX OF TERMS

A

Applications of lasers, 49-59
 Communications, 49
 Manufacturing, 50
 Semiconductor photolithography, 52
 Medical treatment, 54
 Research and laboratory measurement, 55
 Reading, scanning, writing, projection, and holography, 55
 Military lasers, 56, 58
 Adaptive telescope optics, 57

B

Band gap (see also Direct bandgap), 36, 43

D

Direct bandgap, 38
Dye lasers, 4, 46, 57

F

Fiber lasers, 4, 31, 49, 51, 56
 Geometry, 32
 Ytterbium fiber lasers, 30
 Multiple pump sources, 34
 Erbium-doped fiber lasers, 34
 Thulium-doped fiber lasers, 35
Fluorescence, 8
Free-electron lasers, 47
Frequency doubling (see harmonic generation)

G

Gas lasers, 3, 11-19, 51, 52, 54
 Transitions, 11
 Helium-Neon lasers, 12
 Argon-Ion lasers, 15
 Helium-Cadmium lasers, 16
 Carbon Dioxide lasers, 16, 52, 54
 Rare-gas—halide/excimer lasers, 17, 52, 54
 Nitrogen lasers, 19
Gas-dynamic, 17

H

Harmonic generation, 7-8, 25, 27, 29, 34, 35, 56
High-power chemical lasers, 19-20

L

Laser classifications, 3-4
Laser fusion, 58
Liquid lasers (see Dye lasers)

O

Optical parametric amplifier (OPA), 48
Optical parametric oscillator (OPO), 48
Optical pumping, 8

P

Packaging, 9

Q

Quantum defect, 28

R

Radiant efficiency (see Wall-plug efficiency), 3

S

Semiconductor lasers, 3, 36
 Diode lasers, 3, 36, 39, 49, 50, 55
 Gallium Aluminum Arsenide (GaAlAs) diode lasers, 43
 Red diode lasers (GaAlInP/GaAs), 43, 53
 InGaAsP/InP diode lasers, 43
 Nitride diode lasers, 43
 Antimonide diode lasers, 44
 II-VI diode lasers, 44
 Geometry, 40
 Material selection, 42
 Quantum cascade lasers (QCL), 44, 55
 Optically pumped semiconductor laser (OPSL), 45, 54, 55

Solid state lasers, 3, 20-31, 53, 54
 Material selection, 21-22
 Geometry, 23
 Neodymium (Nd) solid state lasers, 24, 51, 53, 56
 Rare-earth-doped lasers, 27
 Titanium-sapphire lasers, 29
 Alexandrite lasers, 30
 Tunable solid state lasers, 30
Spontaneous emission, 37

T

Three-wave mixing, 48
Troubleshooting, 65-67
Tunable lasers, 5, 29, 55, 57

V

Vibronic, 29

W

Wall-plug efficiency, 3, 14, 15, 16, 17, 18, 24, 33, 52

Carbon Dioxide Lasers and Their Applications

Module 2-4

of

Course 2, *Laser Systems and Applications*
2nd Edition

OPTICS AND PHOTONICS SERIES



© 2016 University of Central Florida

This material was developed by the National Center for Optics and Photonics Education, OP-TEC, and is based upon work supported by the National Science Foundation under Grant No. 1144377 and completed under Grant No. 1303732. Any opinions, findings, and conclusions or recommendations expressed in this material are those of the author(s) and do not necessarily reflect the views of the National Science Foundation.

For more information about the text or OP-TEC, contact:

Dan Hull
PI, Executive Director, OP-TEC
316 Kelly Drive
Waco, TX 76710
(254) 751-9000
hull@op-tec.org

Published and distributed by

OP-TEC
316 Kelly Drive
Waco, TX 76710
254-751-9000
<http://www.op-tec.org/>

ISBN 978-0-9983480-3-2

CONTENTS OF MODULE 2-4

Introduction	1
Prerequisites	1
Objectives	2
Basic Concepts	3
Molecular Energy Levels	3
Vibrations and Rotations in Diatomic Molecules	4
Different, But the Same	5
Energy Levels and Transitions in Triatomic Molecules	5
Triatomic Molecular Lasers – CO ₂	6
CO ₂ Laser Composition and Energy Processes	7
Continuous Wave CO ₂ Lasers	8
Slow Axial Flow CO ₂ Lasers	8
Fast Axial Flow CO ₂ Lasers	11
Gas Transport CO ₂ Lasers	13
Waveguide CO ₂ Lasers	14
Intracavity Devices for CO ₂ Lasers	14
Spectral Tuning	14
Pulsing CO ₂ Laser	15
Q-Switching	15
Mode Locking	15
Applications of Carbon Dioxide Lasers	16
References for CO ₂ Laser Applications	17
Summary	17
Safety Considerations	18
Troubleshooting	20
Laboratory	21
Workplace Scenario	24
Problem Exercises and Questions	27
References	28
Index of Terms	29

Module 2-4

Carbon Dioxide Lasers and Their Applications

INTRODUCTION

Many molecular gases are capable of serving as the active medium for laser transitions. These gases usually operate in the infrared region because of the relatively low energies involved in most molecular laser transitions. Manufacturers have developed lasers based on triatomic molecules such as CO₂ and HCN, and others based on diatomic molecules such as CO, HF and DF.

Lasing has been observed in a large number of molecular gases. Of particular importance is the carbon dioxide (CO₂) molecular gas laser, which has lasing transitions at several wavelengths in the infrared, principally around 9.6 μm (micrometers) and 10.6 μm. Because of this infrared output, the CO₂ laser has found many applications in industries ranging from manufacturing to biotechnology. CO₂ lasers are used extensively in materials processing; for example, they are used to drill holes in various substances; to cut metal, cloth, and paper; and to weld materials. In addition, these lasers have been used in laser-induced fusion studies, experimental optical communication and tracking systems, biotechnology processes and medical procedures, and environmental testing and monitoring. Since CO₂ lasers emit light at frequencies exhibiting little atmospheric absorption, they have also become important in many military applications

This module will examine some of the operating processes and output properties of CW CO₂ gas lasers. We will explain the molecular energy states of both triatomic and diatomic molecules and the transitions between them that produce laser light. Next, we will examine the energy transfer mechanisms that occur in molecular lasers and explain how the energy flow process affects the laser's design and output characteristics. These discussions will set the stage for a presentation of the continuous, Q-switched, and mode-locked operation of CO₂ lasers, which result in high energy outputs and large working efficiencies (20% or more).

To provide a hands-on experience with the CO₂ laser, this module includes a laboratory in which you will operate this laser and characterize its output.

PREREQUISITES

OP-TEC's *Fundamentals of Light and Lasers Course*

OP-TEC's *Laser Systems and Applications Course, Module 1: Laser Q-Switching, Mode*

Locking, and Frequency Doubling, Module 2: Laser Output Characteristics and Module 3: Laser Types and Their Applications

Understanding of high school level trigonometry and algebra concepts, including exponentials and logarithms

OBJECTIVES

Upon completion of this module, the student should be able to:

- Name the three types of transitions in molecular spectra and the wavelength regions that are relevant for them.
- State the three gases present in a carbon dioxide laser and give the function of each.
- Draw and label a simplified energy-level diagram for a carbon dioxide laser.
- Explain the primary factor that limits output power of slow axial flow CW CO₂ lasers. Explain how this limitation is overcome in fast axial flow and gas transport lasers.
- Compare characteristics of the following materials when they are used as CO₂ laser mirror substrates. Explain the practical application of each material in CO₂ laser optical systems.
 - Germanium (Ge)
 - Gallium arsenide (GaAs)
 - Zinc selenide (ZnSe)
 - Silicon (Si)
- Explain the fundamental difference between a slow axial flow CO₂ laser and a fast axial flow CO₂ laser. Include comparisons of the following quantities:
 - Tube diameter
 - Tube current
 - Output power per meter
- Draw and label a diagram showing the typical configuration of a gas transport CO₂ laser, including the optical axis and directions of gas flow and current flow.
- Name at least six industrial materials processing applications of CO₂ lasers.
- Use procedures and equipment given in the laboratory to safely operate a CO₂ laser and measure its output.

BASIC CONCEPTS

Molecular Energy Levels

Most lasers we have examined so far in this course have generated laser light through electronic transitions in which an electron in an atom or ion moves from one orbit to another (in the simplified Bohr model) by absorbing or emitting a photon. This simple mode of laser light production is valid for all types of lasers, but not inclusive. When the lasing medium is a molecule, such as carbon dioxide, CO₂, other types of atomic transitions become available for generating laser light.

These additional transitions exist because the structure of a molecule introduces several new possibilities for storing and releasing energy. Molecules not only have atoms with electronic energy levels, but also have their own characteristic vibrational and rotational energy levels.

When atoms combine to form a molecule, they can form structures that allow the binding forces between these atoms to generate vibrational motion relative to one another. Like electronic transitions, this vibrational motion can only have certain discrete amounts of energy. This vibration occurs because the molecules' atoms are bound together by their shared electronic cloud, like balls interconnected by springs. The molecules have natural vibrational frequencies (called normal or resonant modes) that depend upon the masses of their particles and the stiffness of the "springs" connecting the particles. Molecules can transition from one vibrational energy level to another by absorbing or emitting a photon of the proper energy level. Each vibrational possibility (mode) for the molecule involves a particular configuration of its total electronic cloud and, thus, is associated with a specific energy. This gives rise to a discrete set of vibrational energy levels. The effect is to split the electronic energy levels of the molecule into a series of almost equally separated vibrational energy levels.

In addition, because of its structure, a molecule may undergo discrete rotations about various axes in space. Again, the molecule changes from one energy state to another by absorbing or emitting only certain discrete amounts of photon energy. The rotational energy of the molecule further subdivides each vibrational energy level into a series of finely spaced rotational energy levels. Rotational energy levels are not as equally spaced as vibrational levels. Instead, the energy difference between two adjacent rotational levels becomes larger as higher rotational energy levels are reached.

Table 4-1 compares the energies involved in electronic, vibrational, and rotational transitions. It also gives the spectral regions of the photons exchanged (absorbed and released) in each type of transition. The molecule may move from one energy state to another by emitting or absorbing a photon or by colliding with another molecule, an atom, or a free electron.

Table 4-1. Molecular Spectra

Type of Transition	Typical Energy (eV)	Wavelength Region
Electronic	≈ 1–10	Near IR–visible–UV
Vibrational	≈ 0.1–2	Middle IR
Rotational	≈ 10 ⁻⁵ –10 ⁻³	Far IR–microwave

Vibrations and Rotations in Diatomic Molecules

Diatomic molecules (CO, HF, N₂) have structures that provide a very simple model for examining molecular vibrational and rotational modes. Diatomic molecules are composed of two atoms bound together. Such molecules have only one normal or fundamental vibrational mode. This mode, shown in Figure 4-1, consists of a stretching of the molecular bond as the two atoms move away from each other, and a shortening of the bond as they are pulled back toward each other. Such a vibration is the only way in which both momentum and energy can be conserved during the vibration. An increase of the amplitude of this motion corresponds to an increase in the vibrational energy of the molecule.

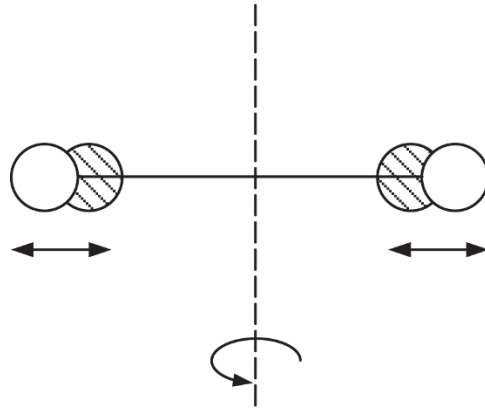

Figure 4-1 *Vibrational and rotational modes of a diatomic molecule*

Diatomic molecules have structures that allow them to also rotate around an axis that is perpendicular to the molecular bond and that passes through the center of mass of the molecule. This is also shown in Figure 4-1. An increase in rotational rate about such an axis corresponds to an increase in rotational energy.

Like electronic energy levels, vibrational and rotational energies can only have discrete values. These discrete vibrational and rotational energies are shown in the molecular energy-level diagram in Figure 4-2.

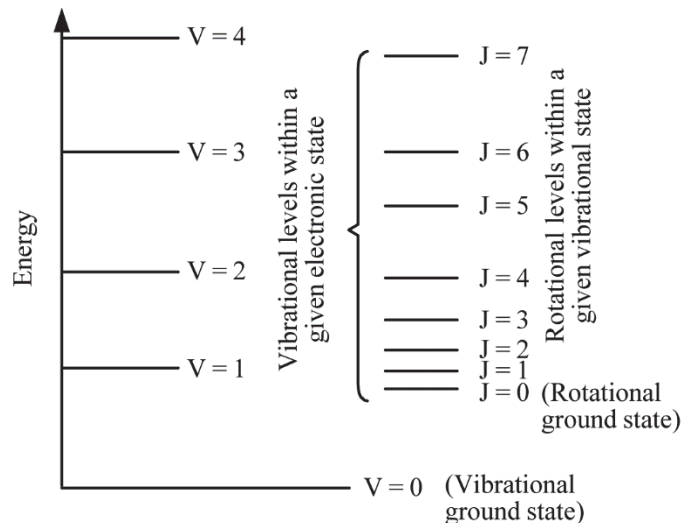

Figure 4-2 *Vibrational and rotational energy levels in a diatomic molecule (levels not to same scale)*

V numbers indicate the various vibrational energy levels of the molecule, and J numbers indicate the various rotational energy levels of these molecules.

Different, But the Same

This course has not discussed, with any rigor, how transitions from one vibrational or rotational state to another produce laser light. In most of our discussions, we have only considered electron transitions from one energy level to another. In those discussions, we explained that laser light is produced when the electrons within an atom transition from higher energy levels to lower energy levels. In laser operations, these electrons typically are pumped to higher energy levels by some external source and then transition quickly (nanoseconds) from these higher energy levels to metastable states. The metastable states allow electrons to reside within them for a relatively long period of time (milliseconds to microseconds), resulting in a population inversion. While the electrons are in these metastable states, photons moving back and forth between the mirrors in the laser cavity interact with them and, through stimulated emission, cause the electrons to drop to a lower energy level. As a result of these electrons transitioning to a lower energy level, new photons are produced that are identical to the ones that stimulated the electron transitions. These new photons add to those already in the laser cavity and the intensity of the laser beam increases.

For transitions from one vibrational or rotational energy level to another, the production of laser light in gas lasers follows almost the same process. However, there is one difference: the production of new photons results not from *electrons* transitioning from metastable states to lower energy states, but from *molecules* transitioning from metastable vibrational and rotational energy levels to lower energy levels. Like electrons, these molecules are raised from their ground states to higher energy levels by some pumping process. In gas lasers, this pumping process usually involves accelerating charged particles through the laser cavity. These charged particles gain kinetic energy as they accelerate and then transfer this energy to gas molecules in the laser cavity by colliding with them. This energy transfer causes the molecules to transition from lower vibrational and rotational energy levels to higher levels. Like electrons at higher energy levels, the molecules at these higher rotational and vibrational energy levels quickly transition to metastable energy levels. Photons moving between the mirrors in the laser cavity interact with these molecules in metastable states and, through stimulated emission, cause them to transition to lower vibrational and rotational states, or even to their ground state. Just like electron transitions, these molecule transitions produce new photons that are identical to the ones that stimulated the transitions. These new photons add to those already in the laser cavity, which increases the intensity of the intracavity laser beam.

Let's now further extend our understanding of how gas lasers operate by investigating the different vibrational and transitional energy modes of triatomic gases.

Energy Levels and Transitions in Triatomic Molecules

Triatomic molecules are composed of three atoms bound together (CO_2 , H_2O , HCN). They exhibit the same types of energy-level diagrams and transitions as do diatomic molecules. The difference between diatomic and triatomic systems is that triatomic molecular structures promote fundamental vibrational modes not available to diatomic molecules. CO_2 molecules are classified as triatomic. Figure 4-3 shows the modes of vibration for this molecule.

In Figure 4-3a, the molecule is in the unexcited ground state, with no intermolecular motion.

Figures 4-3b, 4-3c, and 4-3d show the three normal or fundamental modes of vibration in the CO₂ molecule:

- Symmetric stretching mode (V_1) — a symmetric stretching along the internuclear axis, with both oxygen atoms moving away from or toward the carbon atom at the same time while the carbon atom is stationary (Figure 4-3b).
- Bending mode (V_2) — a vibrational bending motion perpendicular to the internuclear axis, with the carbon atom moving in a direction opposite to the two oxygen atoms (Figure 4-3c).
- Asymmetric stretching mode (V_3) — an asymmetric vibration or stretching along the internuclear axis, with both oxygen atoms moving to the left or right together while the carbon atom moves in the opposite direction between them (Figure 4-3d).

These three modes are the only vibrations of the molecule that conserve both energy and momentum.

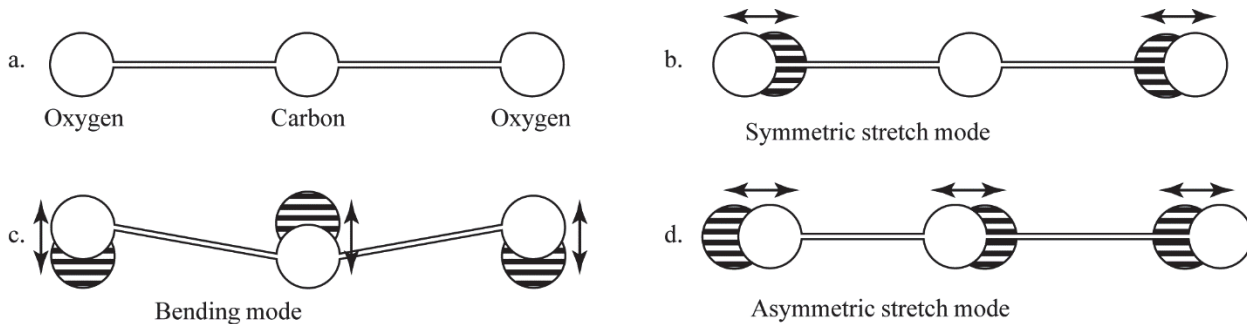

Figure 4-3 Normal modes of vibration for CO₂ molecules

Each of these fundamental modes has discrete energy levels. CO₂ molecules also rotate in the same manner as diatomic molecules and with the same result: each vibrational state is split into a number of rotational energy levels.

Triatomic Molecular Lasers – CO₂

This module uses the CO₂ laser as an example of a triatomic laser for two reasons: First, it is the most frequently used triatomic molecular laser medium, and second, it employs all the energy transfer mechanisms found in other triatomic molecular lasers. The popularity of the CO₂ laser also stems from its relative inexpensiveness, its great efficiency, and the fact that it emits in an atmospheric window—that is, there is little absorption by the atmosphere at its lasing wavelength. Figure 4-4 is a simplified energy-level diagram of a CO₂ laser. This diagram shows only the important vibrational levels. For simplicity, it excludes other vibrational levels and all rotational levels.

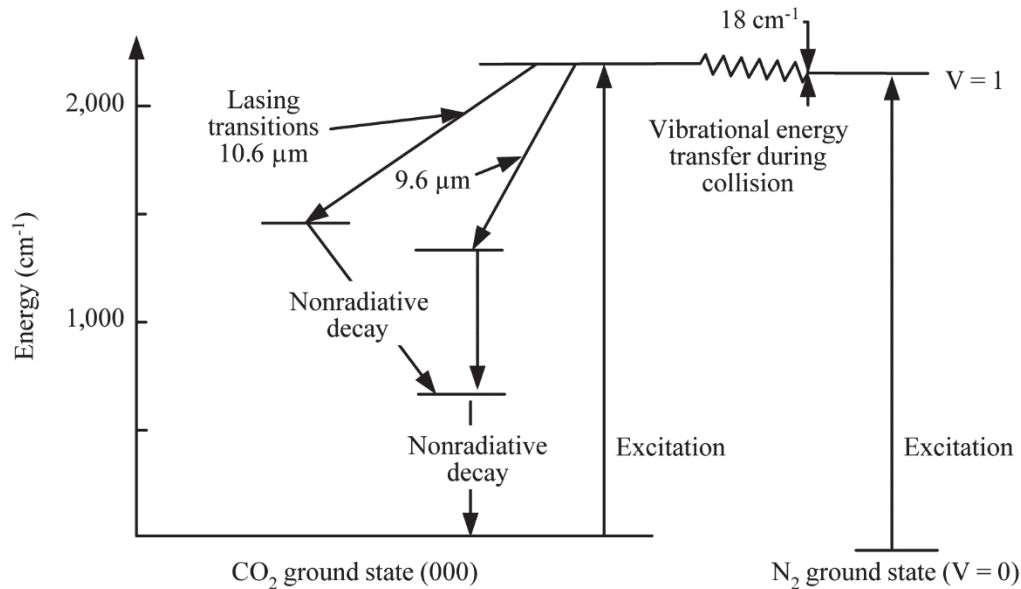

Figure 4-4 Simplified energy-level diagram for CO₂ laser showing vibrational energy transfer

The two strongest lasing transitions in CO₂ are centered at 10.6 μm and 9.6 μm. The 10.6 μm line is the strongest line and is the only one considered during the rest of the module. All energy transfer mechanisms are essentially the same for both the 10.6 μm and the 9.6 μm laser transitions.

CO₂ Laser Composition and Energy Processes

We note here that the gas mixture in a carbon dioxide laser usually contains a mixture of carbon dioxide, nitrogen, and helium, with the last two gases needed for excitation and deexcitation of the carbon dioxide, which is the active element. Although this laser might well be called a carbon dioxide–nitrogen–helium laser, it is almost always simply called a carbon dioxide laser. In most cases, helium is the largest component.

Here is a review of the energy flow through a CO₂ laser:

- The electric field within the laser accelerates a free electron (from ionized He or N₂).
- The electron strikes an N₂ molecule, raising it to an excited state.
- Collisions between the excited N₂ molecules and ground state CO₂ molecules result in the activation of asymmetric vibrational modes of the CO₂ molecules.
- Lasing occurs at 10.6 μm and results in a transition to a lower energy level which decreases the vibrational energy of the CO₂ molecules and switches their primary mode of vibration from asymmetric stretch to symmetric stretch.
- CO₂ molecules, with energy in the symmetric stretch mode, collide with He, resulting in CO₂ in the ground state and helium with kinetic energy.
- The helium strikes the wall confining the laser gases and releases its kinetic energy.
- The cooling fluid removes the waste heat from the system.

The rest of this module explains the design, operation, and applications of carbon dioxide laser.

Continuous Wave CO₂ Lasers

The first part of this module presented the basic theory and operating principles of CO₂ lasers. We can now describe the more important types of CO₂ lasers that have scientific, industrial, and military applications. Because of their predominance, we will focus our discussion on CO₂ lasers classified as continuous (CW) operation.

A wide variety of configurations have been employed for CW CO₂ lasers. These range from small versions used in communications, which produce one watt or less, to the giants of the laser industry, which produce tens of kilowatts. Because of the high power output of CO₂ lasers, designers and operators of these lasers must be aware of the heat load they produce and the damage this heat can cause the laser.

We begin by discussing three classes of CW carbon dioxide lasers: slow axial flow, fast axial flow, and gas transport carbon dioxide lasers.

Slow Axial Flow CO₂ Lasers

The slow axial flow CO₂ laser was the first CO₂ laser developed, and it continues to be common. Figure 4-5 is a diagram of this type of laser. Common characteristics of this CO₂ laser class include the following:

- Water or oil cooling by use of a double-walled glass plasma tube with the coolant in the outer part of the tube
- Gas flow at a low rate (1–20 liters per minute, depending upon size and output of laser)
- DC excitation, coaxial with gas flow and laser beam
- Low-current operation (30-100 mA)
- Gas pressures of 10 to 30 Torr
- Tube diameters of 1.0-2.0 cm
- Available output powers up to about 50 W per meter of tube length

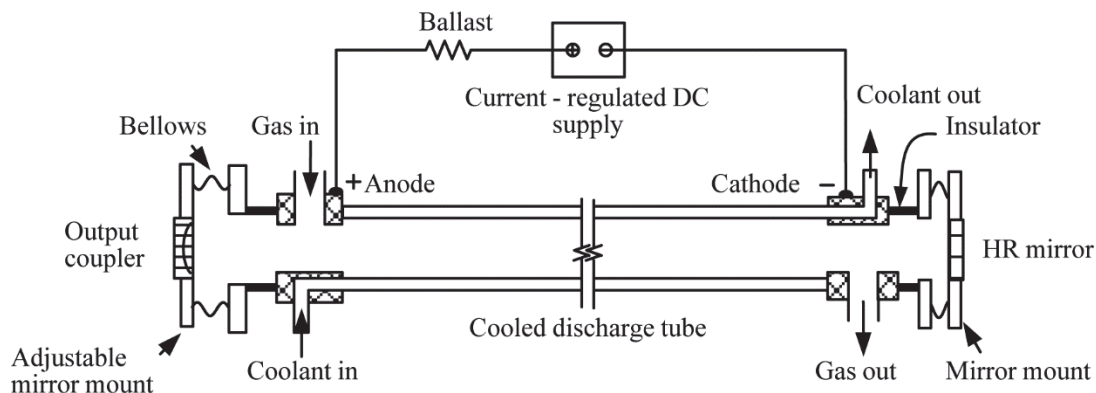

Figure 4-5 Simple coaxial flowing CO₂ laser

The primary factor that limits output power of these lasers is their inability to efficiently remove waste heat from the gas. Cooling is principally achieved through helium (He) collisions with tube walls. Air cooling of CO₂ laser tubes is possible, but this results in an elevated wall temperature and greatly reduces laser efficiency. Smaller CO₂ lasers and those used in research often employ water cooling. Industrial CO₂ lasers usually use recirculating oil as a coolant and oil-to-water heat exchangers for better system stability and reduced maintenance. An increase of tube current beyond the recommended operating value results in more heat than can be effectively removed from the system in this manner. Increases in tube diameter also decrease cooling efficiency by increasing the path length necessary for He atoms to reach the walls from the center of the tube. Thus, the only effective method of increasing the output power of this type of CO₂ laser is to extend the active length. For best results, this must also be accompanied by an increase in gas flow rate. In most larger systems, the gas is recirculated, and a small percentage replaced during each cycle. Table 4-2 lists some operating parameters of several slow axial flow CO₂ lasers.

Table 4-2. Operating Parameters for Slow Axial Flow Carbon Dioxide CO₂ Lasers

Active Length (m)	Output Power (W)	Gas Mixture (CO ₂ :N ₂ :He)	Gas Flow Rate (liter/min)	Power/Length (W/m)	Water Flow Rate (liter/min)
1	50	1:1.5:9.3	1.15	50	2
2	100	1:1.5:9.3	1.15	50	2
5	275	2:1.35:9.3	4.01	55	10
6	375	1:8:23	4.26	62.5	10
9	525	1:6.7:30	4.23	58.3	10
18	1000	1:2.35:17	14.35	55.6	15

Figure 4-6 shows a method of extending active length while minimizing overall dimensions and power-supply cost. The optical cavity has been folded to use two plasma tubes positioned side by side. Commercial CO₂ lasers that use six tubes (and ten turning mirrors) are available and achieve powers of 1 kW. The laser tubes shown in Figure 4-6 have a central anode with a cathode at each end. Separate current regulation is required for each cathode. This is usually less expensive than using a single regulated supply at higher voltages. Typical voltages of 10–15 kV are required for a 1 m discharge, with starting voltage pulses of about twice that value.

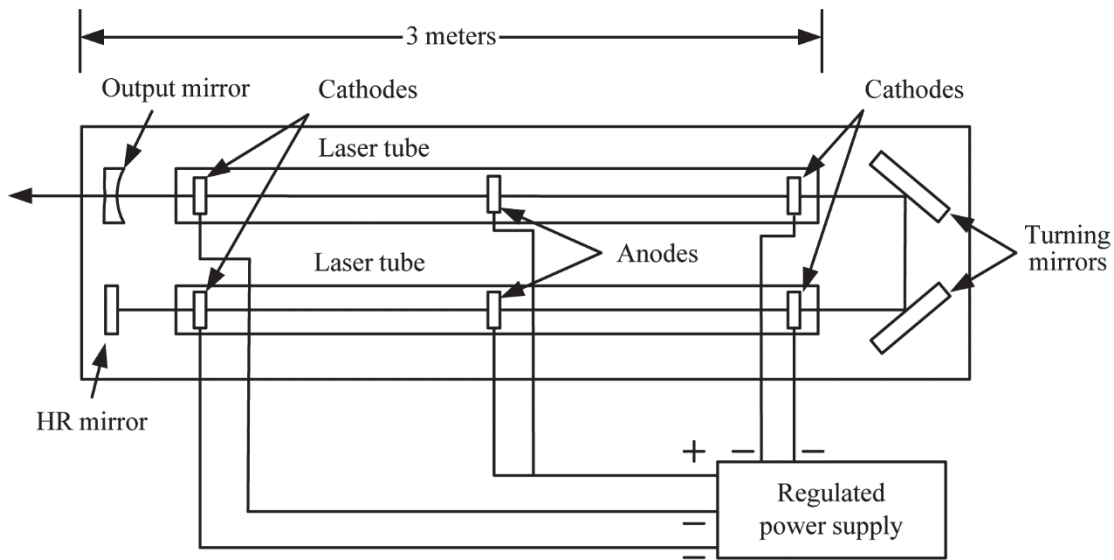

Figure 4-6 Optical and electrical system of 250 W CO₂ laser (overall length of laser head = 3 m)

CO₂ lasers may be constructed with the mirrors as an integral part of the plasma tube, as shown in Figure 4-5, or with Brewster-angle windows and external mirrors. If mirrors are internal, they and their mounts often have high electrical potentials. Granite slabs sometimes are used as optical mounting bases to isolate these voltages and provide good mechanical stability. Invar alloy (a nickel alloy which has very small change in dimension with temperature) provides excellent dimensional stability in systems in which high voltages are not exposed.

Four optical materials are commonly used for CO₂ laser mirrors and output couplers. These are listed in Table 4-3. Germanium (Ge) is the most common output coupler material for lower-power models (< 100 W) because of the cost advantage. Germanium cannot be used on higher-power lasers because it absorbs a significant amount of the laser beam and experiences thermal runaway at approximately 50°C. This means that as the temperature of the substrate increases, its absorption coefficient increases. This leads to higher temperatures and greater absorption until the mirror is destroyed by fracture.

Table 4-3. Characteristics of CO₂ Laser Materials

Material	Absorption at 10.6 μm cm ⁻¹	Thermal Conductivity W/(cm·°C)	Relative Cost
Ge	0.032	0.59	3.5
GaAs	0.02	0.48	6.0
ZnSe	0.005	0.18	5.0
Si	–	1.63	2.0

Gallium arsenide (GaAs) and zinc selenide (ZnSe) are used as output couplers for higher-power CO₂ lasers. Gallium arsenide has a lower absorption coefficient than germanium and a higher thermal runaway point. (We note that the exact value of the absorption coefficient depends on electron concentration and temperature.) It is also resistant to damage from high peak powers and thus is popular for pulsed CO₂ lasers. Zinc selenide has an even lower absorption coefficient, but its thermal conductivity is also low. Zinc selenide has the advantage of

transmitting visible light. This makes optical alignment of the laser much easier. Both of these materials are widely used, with zinc selenide being more popular in the high-power kilowatt range for CW CO₂ lasers. Because the index of refraction of these materials is high, antireflection coatings are required for all transmitting optical components.

Silicon (Si) does not transmit at 10.6 μm, but it does have excellent thermal properties and a considerable cost advantage, and it can be more easily fabricated with a spherical surface than can the other materials. This makes it the most widely used material for low-power, CO₂ high-reflectance (HR) mirrors.

Three common mirror configurations for CO₂ lasers are given in Table 4-4. The long-radius spherical mirror configuration efficiently uses the active medium and provides for ease of alignment. The plane-parallel mirror configuration provides maximum use of the active medium but introduces alignment difficulties. It is used only in CO₂ lasers of output powers around a kilowatt. The plane-spherical configuration is a compromise used on most systems. Notice that mirror reflectivity decreases on higher-power systems. Another common characteristic of higher-power models (> 150 W) is the frequent use of water cooling for mirrors, particularly metal elements.

Table 4-4. Mirror Configurations for CO₂ Lasers

Output Power (W)	Output Coupler		HR Radius (m)	Cavity Configuration
	Radius (m)	Reflectivity (%)		
50	∞ (flat)	85	10	Plane-spherical
100	10	85	10	Long radius spherical
250	∞	65	10	Plane-spherical
1000	∞	27	∞	Plane-parallel

In summary, the slow axial flow carbon dioxide lasers are the least expensive and have the simplest construction. They are commonly used for applications requiring output power up to a few hundred watts.

Fast Axial Flow CO₂ Lasers

Figure 4-7 is a diagram of a fast axial flow CW CO₂ laser. The essential difference between this laser and the slow axial flow device is the gas flow rate. These higher flow rates are achieved by a high-speed blower which circulates the gas through the system. Gas velocity in the laser tube ranges from 100 to 500 m/s. The primary cooling mechanism is convection rather than conduction to the walls. The heated gas passes through a water-cooled heat exchanger that removes waste heat. Common characteristics of this type of CO₂ laser are:

- Available output powers of > 600 W/m
- Tube diameters of 8-15 cm
- Tube currents of 700 mA

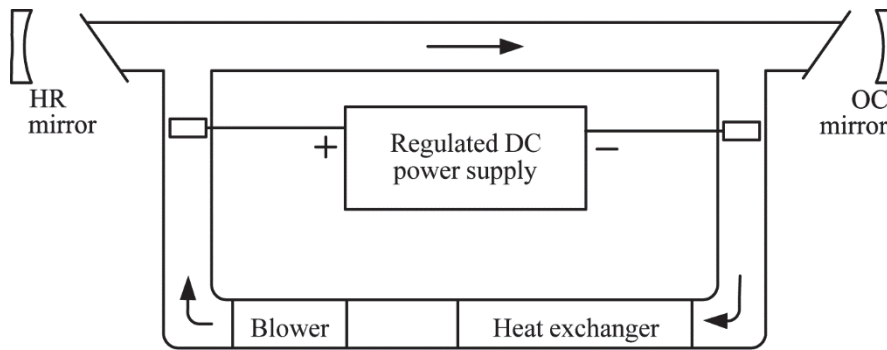

Figure 4-7 *Fast axial flow CW CO₂ laser*

In this type of laser, a single CO₂ molecule is actually in the active region of the tube for less than 0.01 s. The CO₂ molecules are removed from the lasing region, cooled, and introduced into the lasing volume again in the ground state. High efficiencies of the heat exchanger and gas flow system make water cooling of the plasma tube less critical, although some systems do have this feature.

This efficient removal of waste heat also means that higher tube currents may be used to obtain higher output powers. Because tube walls are no longer involved in the thermal transfer, larger diameters may be used without degrading laser output.

Commercial fast axial flow systems are available in the kW power range. Most are folded systems and have water-cooled mirror mounts and rigid resonator frames. Most use the same types of optical cavities as the slow axial flow lasers, but some employ the unstable resonator cavity configuration.

Figure 4-8 is a diagram of such an unstable resonator. It consists of a concave mirror and a convex mirror arranged to have a common center of curvature (point P). Both mirrors have reflectivities greater than 99 percent. Light reflects back and forth within the optical cavity, with part of the light passing around the convex mirror to form the output beam. This produces an output beam in the form of an annular ring (doughnut). The cavity configuration in Figure 4-8 usually is used only on very high-power systems in which partially transmitting mirrors cannot withstand the output power flux. The mirrors used are constructed of metal (usually copper or molybdenum) and are water cooled.

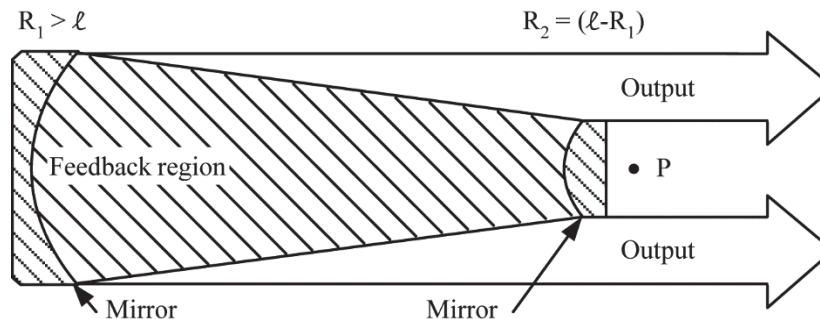

Figure 4-8 *Unstable resonator*

Many of the CW carbon dioxide lasers used in materials processing are fast axial flow carbon dioxide lasers. They are widely used for cutting and welding applications. The output powers are in the multikilowatt range and can reach up to 20 kW.

Gas Transport CO₂ Lasers

In a gas transport CO₂ laser, also called a transverse flow laser, the cooling principle of the fast axial flow device has been carried further. Figure 4-9 is a basic simplified diagram of a transverse flow CO₂ laser. In this laser, the gas flow, current flow, and optical axis are all perpendicular (transverse) to one another. Typical gas velocities are the same as those of fast axial flow lasers, but the length of the gas flow path that is within the lasing region is reduced to a fraction of a meter. A typical gas molecule spends only about 2 ms in the active region. This is about the duration of the lifetime of the upper laser level. Thus, a CO₂ molecule lases from an asymmetric stretch mode energy level to a symmetric stretch mode energy level and is immediately removed from the system. It is then cooled by a heat exchanger and sent through the system again.

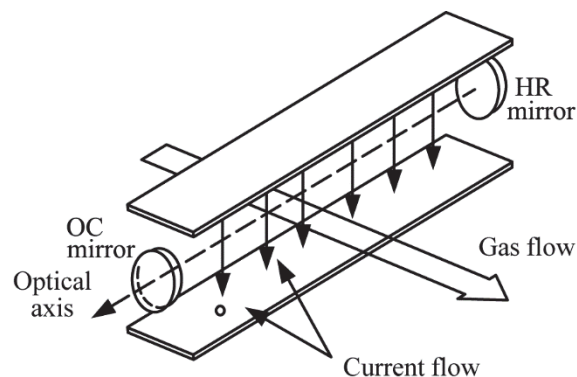

Figure 4-9 *Transverse flow CW CO₂ laser*

Figure 4-10 shows a typical configuration for a gas transport laser. High-speed gas passes through the excitation region, where the nitrogen molecules are raised to a high vibrational state by electron collisions. Collisions between the N₂ molecules and ground-state CO₂ molecules then excite the CO₂ molecules to the upper lasing level. By this time, the gas has moved downstream and into the optical cavity. Lasing occurs, and the gas continues on to the heat exchanger. The gas mixture in all CO₂ lasers discussed thus far is essentially the same. In this system (and in the fast axial flow lasers) the He atoms help transfer waste heat from the CO₂ molecules to the heat exchanger. A small amount of gas (approximately 0.005%) is removed and replaced during each cycle through the laser to help maintain impurities at a low level.

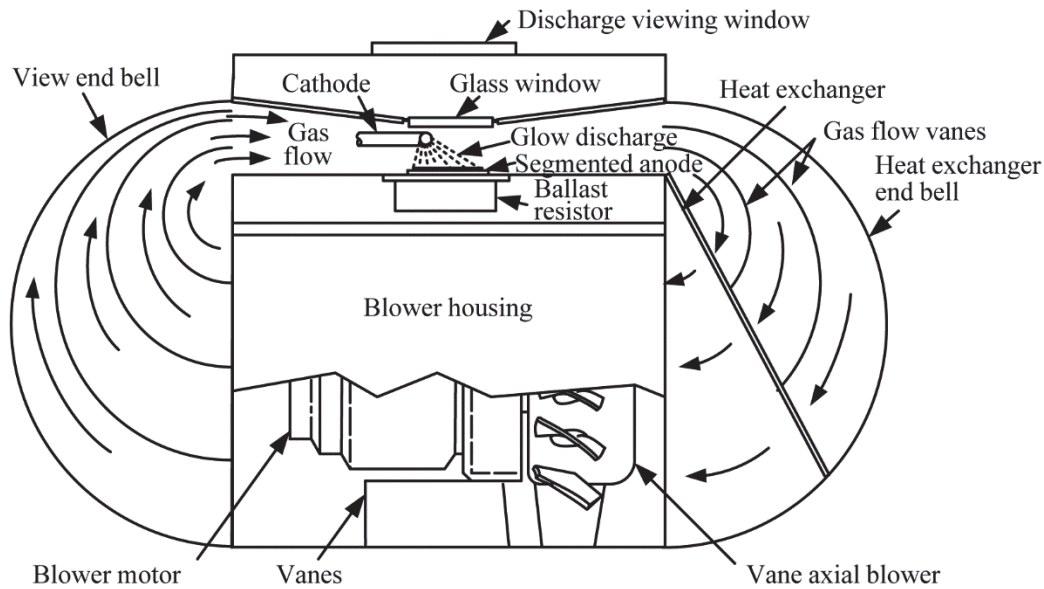

Figure 4-10 Typical configuration of a gas transport laser. The optical axis is perpendicular to the page

The configuration of the gas transport laser can be extremely varied. For example, different electrode configurations provide spatially uniform gas excitation, and different mirror configurations prevent high power densities from damaging the mirrors. Explaining, in detail, these variations, goes beyond the scope of this module.

Gas transport carbon dioxide lasers have provided the highest CW power outputs used in industrial systems. Commercial models with outputs up to 20,000 W are available. Even higher values of power have been produced in carbon dioxide lasers intended for military uses.

Waveguide CO₂ Lasers

The opposite of the large CO₂ lasers described above is the waveguide CO₂ laser. These are small lasers with typical lengths of 5 to 25 cm and bore diameters as small as 1 mm. Bores of these laser tubes are made of beryllium oxide. The hollow dielectric structure acts as a waveguide for the CO₂ laser light, producing a low-loss optical cavity. The small bore diameter results in good gas-cooling efficiency and high gain. Waveguide CO₂ lasers produce output powers of around 0.2 W/cm of tube length. Thus, a laser only 10 cm long can produce an output power of 2 W.

Waveguide CO₂ lasers are rugged and dependable and are attractive for applications in communications, pollution monitoring, and optical ranging systems.

Intracavity Devices for CO₂ Lasers

Spectral Tuning

CW CO₂ lasers use a variety of energy-transition schemes to move from upper energy lasing levels to lower energy levels. These different transition schemes result in the production of

photons that may vary in wavelength from 9.1 to 11.0 μm . Spectral tuning may be used to select a particular wavelength within this range.

Spectral tuning may be accomplished in CW CO_2 lasers by use of a diffraction grating. The grating replaces the high-reflectance mirror and is tilted to reflect the desired wavelength back through the laser cavity. CW CO_2 lasers may be tuned to any one of 90 separate lasing lines between 9.1 and 11.0 μm .

Pulsing CO_2 Laser

Because CW is the predominant mode of operation for CO_2 lasers, this module has emphasized CW operation of these lasers. However, devices can be placed in the cavity of CO_2 lasers that can convert the CW output to a pulsed mode. These devices substantially increase the power output of CW CO_2 lasers, which allows these lasers to be used in a wider variety of applications.

Q-Switching

Q-switching of CO_2 lasers is most commonly accomplished by rotating the high-reflectance mirror at about 20,000 revolutions/min. This produces output pulses of about 50 μs duration with peak powers of several thousand times the CW power of the laser.

A method called *reactive Q-switching* (a form of acousto-optics) also has been used on CW CO_2 lasers. This technique involves translating one of the cavity mirrors along the optical axis at a speed of 16–30 cm/s by a piezoelectric transducer. This changes the frequencies of the cavity modes, allowing several modes to lase briefly as they sweep across the laser gain curve. High pulse repetition rates (30–60 kHz) can be obtained with reactive Q-switching, with pulse widths of about 1 μs and an average output nearly equal to the CW output.

Mode Locking

Mode locking of CW CO_2 lasers may be accomplished with an acousto-optic (AO) device. This technique results in a train of short, high-power pulses, as shown in Figure 4-11.

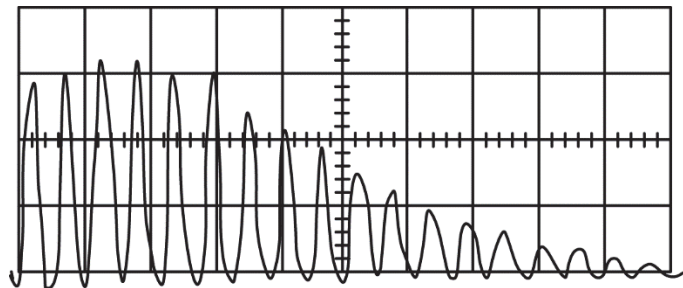

Figure 4-11 *Oscilloscope trace of mode-locked train of pulses from a CO_2 laser, 200 ns/division*

Applications of Carbon Dioxide Lasers

Carbon dioxide lasers have become widely used in industry for materials processing. Table 4-5 lists some important materials-processing applications. Companies hire laser technicians to operate, maintain, and repair these lasers.

Table 4-5. Industrial Applications for Carbon Dioxide Lasers in Materials Processing

Application	Material	Laser Type	Laser Output
Cutting	Metals	CW	Few hundred to 20000 W
Cutting	Wood	CW	Few hundred to 1000 W
Cutting	Paper	CW	Few hundred W
Cutting	Cloth	CW	About 400 W
Cutting	Tile	CW	About 1000 W
Cutting	Plastics	CW	500 to 1000 W
Drilling	Metals	Pulsed	3 J, 0.5 ms pulses
Balancing	Iron Alloy Components	CW or Pulsed	700 W average power
Marking	Plastics	Pulsed	5J, 8 μs pulses
Marking	Glass and plastic	Pulsed	10 J, 10ms pulses
Welding	Metals (mostly ferrous)	CW	250 to 20000W
Welding	Metals (mostly ferrous)	Pulsed	200 W to multikilowatt (average)

Table 4-5 demonstrates that CO₂ lasers have many manufacturing and fabricating-based applications. There are several reasons for this.

- In laser welding applications, the beam power must be controlled carefully. Too much power will produce vaporization of the surface. Too little power will not produce sufficient melting. For this reason, only a few types of lasers are suitable for welding. The high-power CW types such as CO₂ lasers and Nd:YAG lasers are most suitable for seam welding, whereas high-power pulsed versions of these lasers can be used for spot welding. Laser beams are capable of producing strong welds and can satisfy many practical applications in manufacturing. CW lasers with modest power can weld thin metals at reasonably high rates. Multikilowatt CO₂ and Nd:YAG lasers can weld metal samples thicker than an inch.
- CO₂ lasers produce sufficient power to surface treat materials. Surface treatment can produce hardened layers of material at the surface of the workpiece. This increases hardness and improves the wear resistance of the manufactured part.
- The high power output of CO₂ lasers make them excellent tools for cutting a wide-variety of materials. The exact power required will depend on factors such as the thickness of the target material and the desired processing speed.

Another unique feature of CO₂ lasers is that their output is in the infrared portion of the electromagnetic spectrum. This feature expands CO₂ applications to such fields as medicine, environmental monitoring, remote sensing, and the military.

- Because human tissue is highly absorbent at a wavelength of 10 μm, CO₂ lasers have been used in medical applications such as laser surgery and skin resurfacing. They have become well established for treating both benign and malignant skin conditions, including wrinkles, scars, birthmarks, and warts.
- Infrared radiation transmits through the atmosphere with very little energy attenuation. This makes the CO₂ laser particularly suitable in range-finding applications. Likewise, climatologist and environmental monitoring technicians use CO₂ lasers to detect and measure pollutants in the atmosphere.
- The atmospheric transmission properties of infrared radiation are important in many military applications. Many government laboratories have large programs involving the development and application of carbon dioxide lasers.

References for CO₂ Laser Applications

The last section provided a quick overview of how CO₂ lasers are used in research, medicine, industry, and government. To learn more about how CO₂ lasers are used in these fields and the technical details that underlie their applications, we recommend visiting the OP-TEC website (www.op-tec.org) and downloading the following Photonics-Enabled Technologies modules:

- *Laser Welding and Surface Treatment*
- *Laser Material Removal: Drilling, Cutting, and Marking*
- *Lasers in Medicine and Surgery*
- *Diagnostic Applications of Lasers*
- *Therapeutic Applications of Lasers*
- *Spectroscopy and Remote Sensing*
- *Spectroscopy and Pollution Monitoring*

Summary

CW CO₂ lasers are popular for a variety of applications. Several types of CW CO₂ lasers are commercially available. The smallest is the waveguide laser, with lengths as short as a few centimeters and output powers of from less than a watt to a few watts. The most common type of CO₂ laser is one in which the optical axis, current flow, and gas flow are all in the same direction and gas is cooled when helium atoms collide with the cooled tube walls. These lasers are available in powers of several hundred watts. An improvement on this design uses larger tubes, a high gas-flow rate, and heat exchangers to cool gas. Lasers with this design produce output powers of up to 20 kW. The largest commercial CO₂ lasers are multikilowatt systems in which gas flow, current flow, and optical axis are all in different directions. The largest CW CO₂ lasers are used for defense applications.

SAFETY CONSIDERATIONS

Because almost all CO₂ lasers generate more than 500 mW (.5W) of power, they are classified as Class 4 lasers. Because the output of CO₂ lasers is in the far-infrared range at 10.6μm, they are mostly a threat to the cornea of the eye and to the skin. To quantify this threat, we use a quantity called the Maximum Permissible Exposure (MPE), which indicates the greatest exposure most individuals can tolerate without sustaining injury. For a CO₂ laser, the MPE is .1 W/cm² for both 10 s and 3 x 10⁴ s exposures (8 h).

The reason the MPE is the same for both exposure times has to do with an instinctive response humans have when their eyes are exposed to harmful amounts of light. The far-infrared radiation emitted by a CO₂ laser is a thermal hazard to the cornea of the eye and, after the eye is exposed to an irradiance level of .1 W/cm² for 10 s, it will reach a temperature at which physical discomfort occurs. At this temperature, people instinctively avert their eyes and turn their heads so that the eye is no longer exposed to the beam. Regardless of the length of the exposure at .1 W/cm², a person will act reflexively after 10 s to stop any further exposure to the eye.

Another way of quantifying the hazard a CO₂ laser presents is to determine its Nominal Hazard Zone (NHZ). The NHZ describes the region around the laser within which the level of direct, scattered (diffuse), or reflected laser radiation is above the allowable MPE and protective measures are necessary. For instance, the NHZ for a 500 W CO₂ laser for a 10 s and 8 h exposure is 399 m for direct laser-radiation exposure and 5.3 m for a CO₂ laser with a lens that is focusing its output. The following sample calculation determines the NHZ for a 700 W CO₂ laser whose output is passing through a lens with a focal length of 20 cm.

Example 1

Given:

$$P = 700 \text{ W (power)}$$

$$f_0 = 20 \text{ cm (focal length of lens)}$$

$$b = 3 \text{ cm (beam diameter at exit port of laser)}$$

MPE = 0.1 W/cm² at either 10 s or 3 x 10⁴ s (Source: *Fundamentals of Light and Lasers* Table 3-3 or Table 3-5).

$$\text{NHZ} = \frac{f_0}{b} \sqrt{\frac{4P}{\pi(\text{MPE})}}$$

$$\text{NHZ} = \frac{20}{3} \sqrt{\frac{4 \cdot 700}{\pi \cdot (0.1)}}$$

$$\text{NHZ} = (6.67) \cdot (94.41) = 629.71 \text{ cm} \cong 6.3 \text{ m}$$

Because CO₂ lasers are classified as Class 4, a *DANGER* sign must be placed in the laser environment, and an SOP (standard operating procedure) should be written and followed. Figure

4-12 shows examples of the proper *DANGER* signs that should be used for various classifications of lasers.

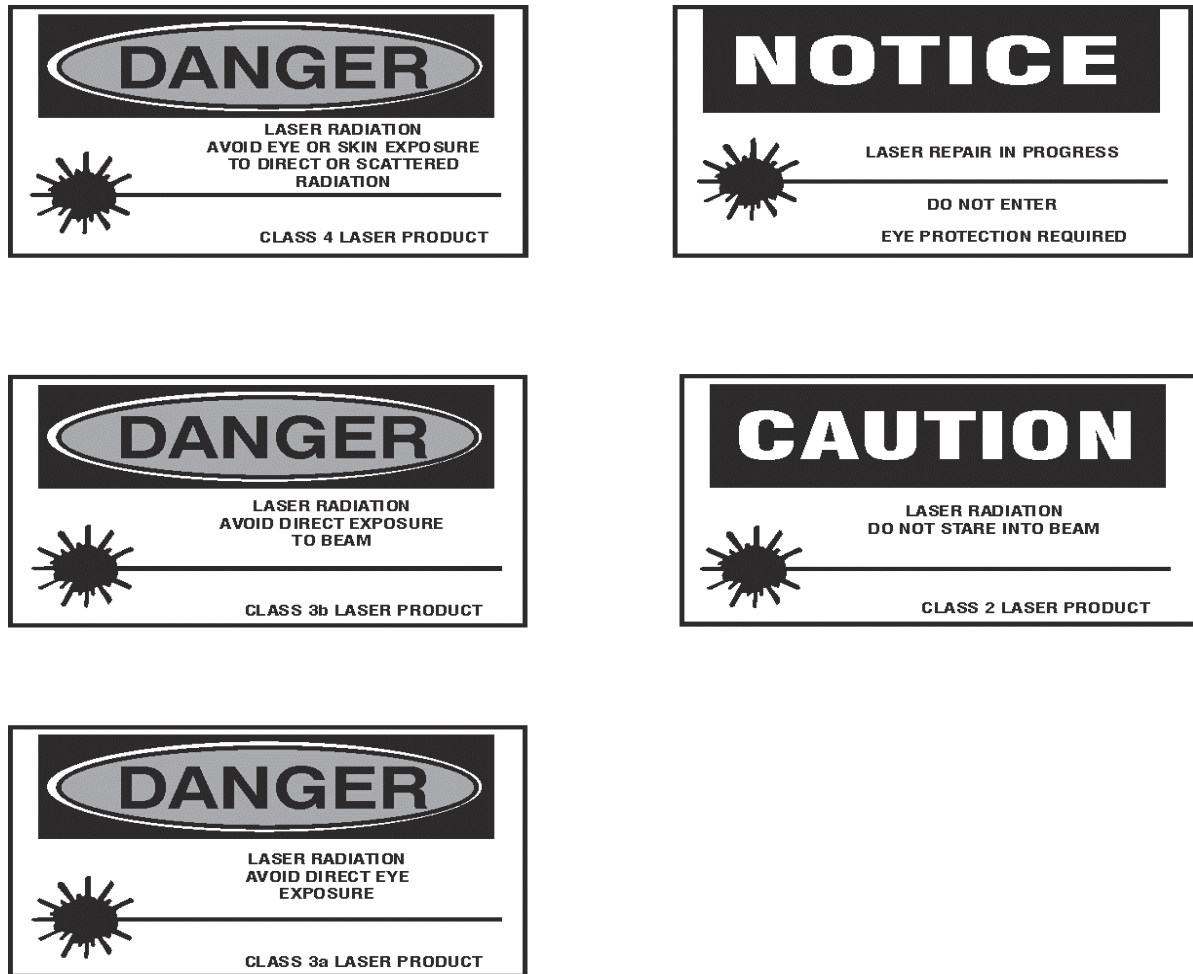

Figure 4-12 *Laser area warning signs*

Since a CO₂ laser is a Class 4 laser, you would need to post within the environment of this laser a danger sign like the one at the top left of Figure 4-12.

Eye protection also must be worn, and it must have the appropriate OD (optical density)—usually, an OD of 5 to 6 should suffice. If you use clear polycarbonate glasses with brow bar and side shields, make sure they are of proper thickness. Always check with your LSO (laser safety officer) for guidance. Improper eyewear and eyewear failure are responsible for 24% of all laser accidents.

CO₂ lasers should come from the manufacturer with the proper *engineering controls* that further ensure the safe operation of the laser. These controls include protective housing interlocks, emission interlocks, and emission delays. If you modify or change any of these, make sure your LSO evaluates these changes and a new SOP is written. Also check your standards (ANSI Z136.1 and Z136.5) for guidance. These standards can be obtained from the Laser Institute of America in Orlando, Florida.

TROUBLESHOOTING

Maintaining and Troubleshooting CO₂ Lasers

Because CO₂ lasers operate at a wavelength 10 times longer than that of most other common lasers, their output is absorbed by most acrylic- and glass-based optics. Optics used in lasers with output wavelengths in the visible and near-infrared ranges would be destroyed by CO₂ lasers and so cannot be used. CO₂ lasers require optics that will transmit and reflect 10.6 μm; such optics are composed of materials such as zinc selenide, germanium, silicon, and sodium chloride. The optics in the beam delivery system must also be made from these materials, whether they are flying optics, articulating arms, fixed mounts, or waveguide (hollow core) fiber-optics.

These materials could be affected by or even dissolved in water and the other common solvents that are normally used to clean hard, coated glass optics. Therefore, it is essential that the technician know which cleaning solutions and materials are safe to use with CO₂ laser optics. The best source for this information is the manufacturer of the laser or optical components. Use the manufacturer's specifications to determine the appropriate solutions and cleaning techniques.

Dirty or Damaged Optics:

If the output power of a CO₂ laser is measured to be lower than specifications, the first troubleshooting strategy is to examine the optics to determine if they are dirty or damaged. If they are, then remove, clean, or replace them (using special cleaning methods and solutions made for CO₂ optics), and measure the beam power (and check the mode) after each mirror is cleaned. Clean optics are especially critical for higher-power lasers. Whereas a low-power helium-neon laser with dirty optics will only result in reduced or no lasing, in a 1 kW CO₂ laser, a dirty window or mirror could actually be destroyed by the absorption of the beam energy.

Gas Mixture/Pressure/Flow:

CO₂ lasers operate on a mixture of helium, nitrogen, and carbon dioxide. The correct composition, or ratio, of these gases is very important. The manufacturer sets these ratios, which must be maintained to optimize operation. A change in the gas mixture will create a loss of output power and possibly a mode change.

Some CO₂ lasers have sealed or self-contained tubes for the active gases. This means that the gas mixture is inside the resonator and sealed and so does not require an external gas tank. In these types of CO₂ lasers, the complete cavity must be replaced.

Other CO₂ lasers require an external, refillable, replaceable tank. Ensure that you are using the proper ratio of gases with the correct gas pressures specified for the particular laser. Often, each gas has its own tank, which means that you must monitor gas quantity and pressure for each tank.

Turbo blowers are used to create gas flow in several styles of CO₂ lasers. These blowers may become damaged. If this occurs, there is a possibility that they could cause significant damage to the laser.

LABORATORY

Laboratory 2-4: Measuring Laser Output of a CO₂ Laser

Purpose

When students have completed this lab, they should be able to measure the output power of continuous wave and pulsed CO₂ lasers.

Safety Precautions

Before you turn on any laser, you must do the following two things. First, be certain that everyone in the area is wearing the correct laser eye protection—that is, laser safety goggles or laser safety glasses. Second, inspect the laser so that you understand as much as possible about its operation.

Equipment

1. Continuous wave CO₂ laser
2. Pulsed CO₂ laser
3. Laser energy meter
4. Laser power meter
5. HgCdZnTe detector
6. HgCdZnTe amplifier and output cable with BNC connection
7. 30 W thermopile
8. High-power detector (if more than 30 W of power)
9. Oscilloscope
10. Thermal paper

Pre-Lab Familiarization

A. Review safety procedures

Your instructor will give you an overview of the safety considerations for this laboratory and will provide the necessary eyewear—glasses or goggles.

B. Familiarize yourself with the laser and power meter user manuals

During this laboratory, you will operate a CO₂ laser and a power meter. To ensure an effective use of your time during this laboratory, familiarize yourself with the user manuals for these pieces of equipment. Place special emphasis on start-up, shutdown, and safety procedures.

Procedures

CW CO₂ Laser Power Measurement

1. Observe all safety precautions required in a laser lab.
2. Record the wavelength of the CO₂ laser in Data Table 1.

Data Table 1

Laser Wavelength in nm	
---------------------------	--

3. Follow the start-up procedures in the operations manual for the continuous wave CO₂ laser. Be sure the beam is blocked before powering up the laser.
4. Place a piece of thermal paper across the laser beam path, and make sure the beam leaves a trace on the paper.
5. Attach a piece of thermal paper to the beam block (fire brick) and carefully drag the beam block across the table surface until the full width of the beam is traced on the thermal paper.
6. Follow the start-up procedures for the power meter, and set it for the laser wavelength that you measured in step 2.
7. Place the detector of the power meter in the beam path between the laser and the beam block.
8. Measure and record the power reading in Data Table 2.

Data Table 2

Power (W)	Width of Burn line (d)	Area of beam spot ($\pi d^2/4$)	Irradiance = (Power/Area)

9. Power down the laser according to the shutdown procedures in the CO₂ laser user manual.
10. Measure the beam width that you traced in step 5. This width is the diameter of the laser beam. Record this width in Data Table 2.
11. Calculate the area of the beam spot.
12. Calculate the irradiance of the beam and record it in Data Table 2.

Pulsed CO₂ Laser

1. Follow the start-up procedures in the CO₂ user manual.
2. Set the laser frequency to 15 Hz.
3. Attach the high-power detector to the power meter.
4. Using procedures presented in the user manual, turn on the power meter.

- Pulse the laser and record the average power in Data Table 3.

Data Table 3

Trial	Average Power (W)	Pulse width	Energy (joules)	PRT	PRR	Pmax
1						
2						
3						
Avg						

- Using the procedures in the user manual, shut down the laser.
- Attach the thermopile to the energy detector and place the thermopile in the beam path.
- Turn on the energy meter according to the instructions in the user manual.
- Attach the HgCdZnTe detector unit to the oscilloscope.
- Set the oscilloscope sweep parameters to capture and display the laser's pulse.
- Position the HgCdZnTe detector unit so that it can SAFELY catch the signal reflected from the energy detector. (This should be off axis and 2–3 feet from the reflection. NOTE: You may need to experiment from farther away to prevent damage to the detector.)
- Set the laser to a single-pulse mode.
- Fire the laser and record the energy in Data Table 3.
- Using the trace on the oscilloscope, measure the pulse width of the laser output and record in Data Table 3.
- Repeat steps 5–14 two more times and record the data in Data Table 3.
- Using results from Module 2-2, complete the calculations in Data Table 3.

WORKPLACE SCENARIO

Here is your opportunity to use the concepts you have learned in this module to solve an actual problem that could arise in a photonics company. Your instructor will provide directions for developing a solution.

Installing, Operating, and Maintaining a CO₂ Laser Welder

Scenario

Your organization has purchased a CO₂ laser welder (Trumpf, TruFlow Model 8000). It may be used to weld steel, aluminum, copper, and brass. You have been assigned the following tasks to prepare for the arrival and installation of this equipment:

- The system's parts are as large as 0.5 square meters. Describe a room that could be used to house this system. Your description should include these characteristics of the room:
 - Appropriate size (dimensions).
 - Electrical power and cooling requirements. Do you need a “power kill” switch?
 - Lighting requirements for alignments, operations, and inspection.
 - Will special gas be needed to accomplish the welding operation?
- Determine the required safety equipment (curtains, shields, goggles, electrical grounding, etc.)
- Materials handling: Do you move the part or the laser head to advance the weld?
- Prepare a concept diagram of the room and list the tables, equipment, and other furniture you will need to support the laser and parts operation (raw materials, storage, parts handling, measurements, etc.). Describe the assumptions you have made to prepare this diagram.
- Review the equipment maintenance manual. What spare parts should be stocked? In what quantities? What other information will be important to facilitate the preparation and use of this equipment?

Initially, the equipment will be used to weld 14 inch sheets of ½ inch stainless steel.

1. How many parts can be welded per hour?
2. Quality control of the welded part:
 - a) What are the dimensional tolerances of the weld?
 - b) What smoothness is required on the weld surface (will it have to be ground, filed or sanded)?

Additional Information

You can find the information you need to solve this problem from at least three sources:

1. A description of CO₂ laser operation, components, output characteristics, and special requirements can be found in Module 2-4, *Carbon Dioxide Lasers and Their Applications*.
2. Additional information is in the OP-TEC Photonics-Enabled Technologies (PET) module entitled *Laser Welding and Surface Treatment*.
3. Check the Internet site for the laser equipment manufacturer and model number. A detailed search of this site will reveal the following information about the specific laser welder:
 - a) System operating (output) parameters of power, PRF, wavelength, cutting speed for different material types, and thickness.
 - b) System specifications.
 - c) Performance.
 - d) Operating/maintenance manuals.
 - e) Contact information for the manufacturer's representative, who can clarify information on the website and provide information about specific performance parameters.
 - f) Your instructor has documents from Trumpf or can direct you to them.

Data Collection

1. Obtain an equipment manual from the manufacturer or your instructor.
2. Identify the manufacturer of the laser welding equipment and search the Internet site for available information.
3. Prepare a data table to summarize the operating requirements and performance parameters that have been specified and requested.

Problem and Tasking

1. Are all the capabilities of the laser equipment specifications appropriate for the requested applications? Provide your rationale for these selections in a report, based on the following criteria:
 - a) Performance
 - b) Speed
 - c) Versatility
 - d) Cost
 - e) Power consumption/facility requirements
2. Many sketches of the operations room and required equipment might be suitable. Your solution will be unique and open-ended. Provide the process and rationale you used to arrive at your design.

3. If you cannot find all the information you require from the website, you should call or email the customer service representative for help.
4. Make a presentation on the results in your report

PROBLEM EXERCISES AND QUESTIONS

1. Name the three types of transitions in molecular spectra and the wavelength regions that are relevant for them.
2. Draw and label diagrams showing symmetric stretch, bending, and asymmetric stretch vibrational modes in a carbon dioxide molecule.
3. State the three gases present in a carbon dioxide laser, and give the function of each.
4. Draw and label a simplified energy-level diagram for a carbon dioxide laser.
5. Describe the energy flow through a CO₂ laser.
6. Explain the primary factor that limits output power of slow axial flow CW CO₂ lasers. Explain how this limitation is overcome in fast axial flow and gas transport lasers.
7. Compare characteristics of the following materials when they are used as CO₂ laser mirror substrates. Explain the practical application of each material in CO₂ laser optical systems.
 - a) Germanium (Ge)
 - b) Gallium arsenide (GaAs)
 - c) Zinc selenide (ZnSe)
 - d) Silicon (Si)
8. Explain the fundamental difference between a slow axial flow CO₂ laser and a fast axial flow CO₂ laser. Include comparisons of the following quantities:
 - a) Tube diameter
 - b) Tube current
 - c) Output power per meter
9. Draw and label a diagram showing the typical configuration of a gas transport CO₂ laser, including the optical axis and directions of gas flow and current flow.
10. Name at least six industrial materials-processing applications of CO₂ lasers.

REFERENCES

- Duley, W. W. 1976. *CO₂ Lasers Effects and Applications*. New York: Academic Press.
- Frauenpreiss, Thorsten. 2008. CO₂ Lasers: The Industrial Workhorse. In *The Photonics Handbook 2008*. Pittfield, MA: Laurin Publishing.
- Laser Focus World. 2013. Laser Specification Tables. *Laser Focus World 2013 Buyers Guide*. Nashua, NH: PennWell Corp. <http://buyersguide.laserfocusworld.com/tabs/laser-specification-tables.html> (accessed November 12, 2013).
- Lemer, Eric J. 1998. Carbon Dioxide Lasers Deliver Flexibility and Power. *Laser Focus World*, October 1. <http://www.laserfocusworld.com/articles/print/volume-34/issue-9/world-news/carbon-dioxide-lasers-deliver-flexibility-and-power.html> (accessed November 12, 2013).
- Matthews, Stephen J. 2001. Back to Basics: Carbon Dioxide Lasers. *Laser Focus World*, May 1. <http://www.laserfocusworld.com/articles/print/volume-37/issue-5/features/back-to-basics/still-going-strong.html> (accessed November 12, 2013).
- Ready, John F. 1997. Chapter 3 in *Industrial Applications of Lasers*. San Diego: Academic Press.
- Ready, John F., ed. 2001. Chapter 2 in *Handbook of Laser Materials Processing*. Orlando, FL: Laser Institute of America.

INDEX OF TERMS

A

Applications, 16

C

Continuous wave (CW) CO₂ laser, 8

E

Energy flow through CO₂ laser, 7

F

Fast axial flow CO₂ lasers, 11-13

G

Gas transport CO₂ lasers, 13

I

Intracavity devices, 14-15

 Spectral tuning, 14

 Pulsing, 15

 Q-switching, 15

 Mode locking, 15

N

Normal modes of vibration, 6

S

Safety considerations, 18-19

Slow axial flow CO₂ lasers, 8-10

 Operating parameters, 9

 Material selection, 10

 Mirror configuration, 11

T

Transitions, 1, 5

Transverse flow CO₂ lasers (see Gas transport lasers), 13

Triatomic molecules, 5

Troubleshooting, 20

W

Waveguide CO₂ lasers, 14

Fiber Lasers and Their Applications

Module 2-5

of

Course 2, *Laser Systems and Applications*
2nd Edition

OPTICS AND PHOTONICS SERIES



© 2016 University of Central Florida

This material was developed by the National Center for Optics and Photonics Education, OP-TEC, and is based upon work supported by the National Science Foundation under Grant No. 1144377 and completed under Grant No. 1303732. Any opinions, findings, and conclusions or recommendations expressed in this material are those of the author(s) and do not necessarily reflect the views of the National Science Foundation.

For more information about the text or OP-TEC, contact:

Dan Hull

PI, Executive Director, OP-TEC

316 Kelly Drive

Waco, TX 76710

(254) 751-9000

hull@op-tec.org

Published and distributed by

OP-TEC

316 Kelly Drive

Waco, TX 76710

254-751-9000

<http://www.op-tec.org/>

ISBN 978-0-9983480-4-9

CONTENTS OF MODULE 2-5

Introduction	1
Prerequisites	1
Objectives	1
Basic Concepts	2
Basic Structure of Fiber Lasers	2
Fiber Loop	2
Fiber Material	3
Rare Earth Elements	3
Core Materials	4
Mirrors	5
Pump Sources	6
Fiber Couplers	6
From Pump to Output	7
Master Oscillator Power Amplifier (MOPA)	8
Pulsing Methods	9
Pulsing the Pump Source	9
Q-Switching	9
Mode Locking	10
Output Characteristics of Fiber Lasers	12
Range Of Wavelengths	12
Beam Divergence Angle	13
Advanced Structures	13
Double-Clad Fibers	13
Chirally Clad Cores	14
Large Mode Area (LMA) Fibers	14
Fiber-Disk Lasers	15
Raman Fiber Lasers	15
Fiber Laser Applications	16
Advantages of Fiber Lasers	17
Applications in Materials Processing	20
Other Applications	24
Safety Considerations	30
Troubleshooting	32
Laboratory	33
Workplace Scenario	39
Problem Exercises and Questions	40
References	41
Index of Terms	42

Module 2-5

Fiber Lasers and Their Applications

INTRODUCTION

Fiber lasers are a relatively new type of laser based on optical fibers doped with various chemical elements. Many other types of lasers, based on active materials such as solid rods, gases, or semiconductors, have also been developed since 1960, and many of these have reached a state of relative maturity. The use of optical fibers for communication purposes has also become familiar, but the use of optical fibers as the active medium in lasers is fairly new, and applications of fiber lasers are still in a state of rapid development. This rapid development is in part due to advantages that fiber lasers offer over other types of lasers, such as high efficiency, long lifetime, and small size. They have become important in materials processing, and other applications are rapidly being developed.

This module will describe the structure, properties, and applications of fiber lasers.

PREREQUISITES

OP-TEC's *Fundamentals of Light and Lasers Course*

OP-TEC's *Laser Systems and Applications Course, Module 1: Laser Q-Switching, Mode Locking, and Frequency Doubling, Module 2: Laser Output Characteristics and Module 3: Laser Types and Their Applications*

Understanding of high school level trigonometry and algebra concepts, including exponentials and logarithms

OBJECTIVES

Upon completion of this module, the student should be able to:

- Draw and label the components of a fiber laser.
- Explain the different optical fiber materials used in fiber lasers.
- List the materials used in doping a fiber laser.
- Describe the basic structure of an optical fiber.

- Name and describe the different kinds of mirrors used in fiber lasers.
- Name the different configurations of pump sources used in fiber lasers.
- Trace the pathway of pump light through a fiber laser.
- Define *critical angle* and explain its role in effectively pumping a fiber laser.
- Explain the operation of a fiber laser, starting from its pump source and ending in the emission of laser radiation.
- Define a MOPA and describe its use.
- Characterize the output of both CW and pulsed fiber lasers.
- Describe various methods of pulsing a fiber laser, including mode locking and Q-switching.
- List advanced optical fiber structures and explain how these structures improve the properties of fiber lasers.
- Name and explain the advantages in using fiber lasers.
- Describe how fiber lasers are used in manufacturing, telecommunications, spectroscopy, medicine, and the military.
- Use procedures and equipment given in the laboratory to safely operate a fiber laser and measure its output.

BASIC CONCEPTS

Basic Structure of Fiber Lasers

All lasers share common components. Each type of laser has some kind of pumping mechanism that generates a population inversion, a lasing material that has a metastable state to promote and sustain the stimulated emission process, and a laser cavity containing a high-reflectivity mirror and a coupling device that keep most of the laser light contained in the laser cavity while allowing some to be released as output radiation. Fiber lasers have these same components, but they are unique in that their laser cavity is an optical fiber that is doped with lasing material.

In this section, we describe this unique laser configuration and explain how coherent, monochromatic laser light is generated within it.

Fiber Loop

The basic structure of a fiber laser contains a doped optical fiber, which is the active medium. Figure 5-1 shows how a simple fiber laser is arranged.

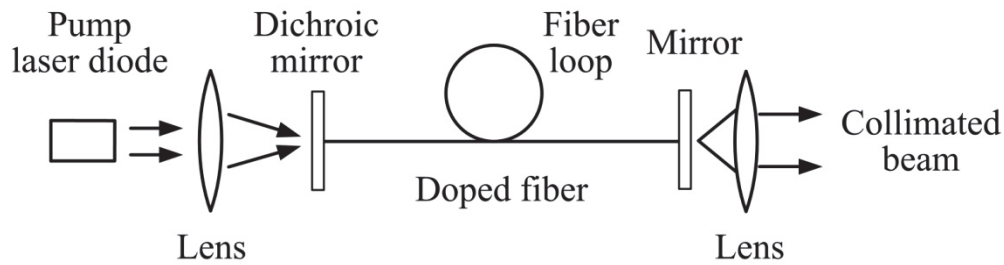

Figure 5-1 *Arrangement of a simple fiber laser*

Figure 5-1 shows, in many fiber lasers, the fiber is coiled in a loop. This allows a long length of fiber to fit into a compact space. This is one of the advantages of fiber lasers. The fiber is an optical fiber with a core that contains the active material for laser operation and a cladding that confines the pump light. Light from the pump source—often a laser diode or diodes—is incident from the left. The lens concentrates the pump light on the fiber’s end. The first dichroic mirror transmits the pump light but reflects the wavelength of the fiber laser. The second mirror allows part of the light in the cavity to be transmitted. The two mirrors form the laser cavity. The final lens collimates the beam. The basic structure in this figure may be suitable for simple experiments in a student laboratory. More sophisticated structures are described later.

Fiber Material

A variety of materials have been used as the basic fiber material. The basic material must be transparent at the wavelength of operation so that the light produced during laser operation is not absorbed. The most widely used material is silica-based glass, the same material used in fibers for optical communications. Zirconium fluoride-based fibers are also used. Silica fibers are used for operation in the visible and near infrared, ranges, while zirconium fluoride materials are used at longer wavelengths in the infrared range. Recently, researchers have also been investigating phosphate-based glasses because higher concentrations of rare earth elements can be incorporated into them compared with silica-based glasses.

Rare Earth Elements

Rare earth elements are very attractive as dopants for fiber lasers. Without these dopants, optical fibers cannot produce laser light. The rare earth elements are those with atomic numbers from 58 through 71 in the periodic table. The electron energy levels in these rare earth elements have energy differences and metastable states that support laser operation. Because of these properties, a fiber doped with one of these rare earth elements, gains the capability of initiating and sustaining laser light production. Some of the rare earth elements used in fiber lasers include ytterbium (Yb), erbium (Er), thulium (Tm), neodymium (Nd), holmium (Ho), and praseodymium (Pr). Table 1 lists some of the properties of lasers based on these elements.

Table 5-1 Output and Pump Wavelengths of Some Rare Earths Used in Fiber Lasers

Element	Output Wavelength (nm)	Pump Wavelength (nm)
Ytterbium	1030 to 1100	910 to 975
Erbium	Around 1550	1480 and 1980
Neodymium	1064 to 1088	808
Thulium	1900 to 2100	793
Holmium-Praseodymium	2874	1064
Ytterbium-Praseodymium	492	650 followed by up conversion of 635 nm light emitted by ytterbium

Core Materials

The core of the fiber is the active medium that emits laser light. The core may often be some type of glass doped with a chemical element—usually a rare earth element.

Fiber Structure

The original structure for fiber lasers involved directing the light from the pump source directly into the rare-earth-doped core of fiber that was at the center of the circular fiber. Now, many high-power fiber lasers use what is called *double-clad* fiber. In double-clad fiber, the active medium with rare earth doping still forms the core of the fiber, but this core is surrounded by two layers of cladding. The laser light propagates in the core. The pumping light beam propagates in the inner cladding layer. The outer cladding layer keeps this pump light confined within the inner core. With this structure, the core can be pumped with higher power than would otherwise be possible. In early fiber lasers, the core was usually 5–10 μm in diameter, but now, cores with diameters up to hundreds of micrometers are common because they allow for higher levels of output power.

Figure 5-2 shows the profile of the index of refraction for a simple double-clad fiber. The pump light enters the inner cladding and travels along the length of the fiber. It is confined within the inner cladding by total internal reflection. As it travels, it gradually leaks into the core, exciting the core, which generates the laser light. The inner cladding is sometimes called the *pedestal*, and the outer cladding is simply called the *cladding*.

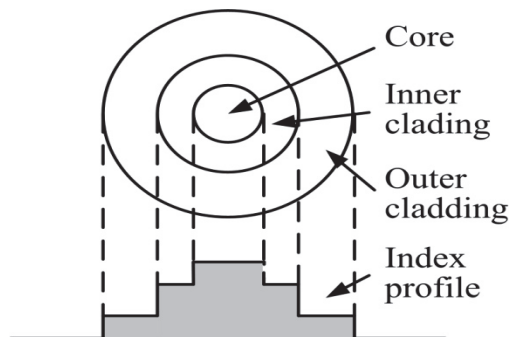

Figure 5-2 Profile of the index of refraction through the center of a circular double-clad fiber

This double-clad structure allows fiber lasers to operate in a single transverse longitudinal mode at greater power levels than would otherwise be possible. Single-mode operation is desirable because the beam quality is better, which enables focusing on smaller spots. Power can be increased by increasing the diameter of the core. But as the core diameter increases, the output beam may become multimode.

The simplest design of a double-clad fiber is obviously one with circular symmetry, with a single core in the center, as shown in Figure 5-2. But many other designs have been demonstrated. These include designs with an off-center core, designs with multiple cores within the inner cladding, designs with an elliptical inner cladding, and designs with a rectangular inner cladding. On occasion, fibers may even feature noncircular (for example, octagonal) cross sections. Finally, fibers with square cross sections are used to enhance the coupling of pump light into fibers.

Mirrors

Various types of mirrors can form the cavity for a fiber laser. These mirrors can be multilayer dielectric mirrors, distributed Bragg reflectors, or semiconductor saturable absorber mirrors, called SESAMs.

Multilayer Dielectric Mirrors

Multilayer dielectric mirrors are formed of thin layers of dielectric materials, such as titanium dioxide and magnesium fluoride. These mirrors are prepared by vacuum deposition. The mirrors consist of alternating layers of materials with high and low indexes of refraction. The choice of materials and layer thicknesses allows the designer to produce any desired reflectivity at the laser wavelength. These mirrors are commonly used in gas lasers and solid-rod lasers.

Distributed Bragg reflectors (DBRs) are complex multilayer dielectric mirrors that use $\frac{1}{4}$ wavelength stacks. If the layer thickness is one-quarter wavelength of the light, the reflections combine with constructive interference. The layers function as a reflector for that wavelength, whereas light at other wavelengths is transmitted. Distributed Bragg reflectors have commonly been used in optical fibers for other applications—for example, in notch filters for optical communications. Now, they are often used for mirrors in fiber lasers.

Semiconductor Saturable Absorber Mirrors

Semiconductor saturable absorber mirrors, often denoted SESAMs, are another type of mirror frequently used with fiber lasers. They are often used with fiber lasers intended to emit very short pulses in the picosecond or femtosecond regions. They are formed by layering stacks of semiconductor materials onto a distributed Bragg reflector. The semiconductor stacks may be alternating layers of AlAs and GaAs grown on a GaAs substrate. The index of refraction in the stack alternates between 3.0 and 3.5. On top of the stack, an InGaAs absorbing layer is grown.

As the fiber laser is pumped, light begins to build up in the fiber, but the laser cannot operate because the light strikes the InGaAs layer and is absorbed. As the light is absorbed, it raises electrons from the valence band to the conduction band. The population of the valence band is quickly depleted, and the absorption decreases. In other words, the absorption is saturated. Then light can reach the Bragg reflector. The reflection by the SESAM at the end of the fiber can rise very rapidly, from near zero to near unity, in a fraction of one picosecond. Then the optical cavity is established and laser operation can proceed. After some time, the electrons fall back to

the valence band, absorption resumes, and laser operation stops until the SESAM is again saturated.

Pump Sources

Most fiber lasers are pumped by semiconductor diode lasers. Table 5-1 indicates the pumping wavelengths for various rare earth elements. The wavelengths are within the range that can be supplied by semiconductor lasers. But in some cases, the pump light has been supplied by other types of laser, such as Nd:YAG.

Semiconductor laser diode sources are available to cover the range of wavelengths needed to pump fiber lasers. For example, aluminum gallium arsenide lasers are sometimes used; their output ranges from 750 to 950 nm. This range of wavelengths will pump some of the fiber laser materials given in Table 5-1. Other semiconductor materials are used for the other wavelengths.

Frequently, the output of the diode laser is directly injected into the laser fiber. To increase the pump power reaching the fiber, multiple diode lasers may be used. This is shown in Figure 5-3.

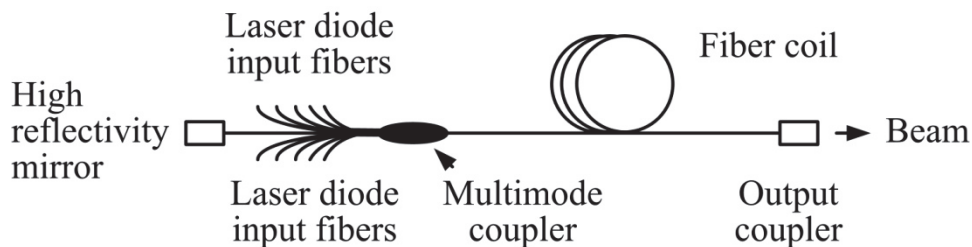

Figure 5-3 Schematic diagram of pumping a fiber with multiple laser diode sources

The multimode coupler allows the light from several fibers, each of which carries the light from one pump source, to be combined in a single fiber.

High-power fiber lasers with a multi-kilowatt output power level are now available from a number of suppliers. Such devices require higher-brightness laser diode pumping sources. This means that multi-emitter diode laser bars are needed. New high-brightness bars have increased cavity length. They also use brightness-matching micro-optics so that multiple emitters from a single bar can be coupled into one fiber. Using this multi-emitter approach, it is possible to deliver 40 W of pump light from a 10 mm bar of diode lasers at a wavelength near 790 nm.

Pump light is often injected into the fiber ends, as Figure 5-1 shows. But it is also possible to use side-pumping techniques.

Fiber Couplers

As we have mentioned, the light from a diode laser pump source is often emitted directly into a fiber, and this fiber is then coupled into the laser fiber. Fiber couplers are devices with one or more input fibers and one or more output fibers. In fiber lasers, it is most common to have multiple inputs and one output fiber so that a number of semiconductor lasers may pump a single fiber.

Couplers are generally one-way devices, so that light coming from the source is not directed back toward the source. All couplers introduce some amount of loss, that is, some light is not

transmitted. Any amount of misalignment will cause loss. The alignment must be accurate on a micrometer scale. Some of the best couplers have insertion losses of 0.2%, but most have somewhat greater losses. There are many commercial suppliers of fiber couplers, creating a wide variety of choices.

From Pump to Output

Let's now integrate together all the fiber laser concepts and components just described and look at the operation of the fiber laser from a system perspective, starting with the pumping mechanism and ending with the production and transmission of laser light. For this system perspective, we will use the general fiber laser system shown in Figure 5-3 and assume a double-clad configuration as depicted in Figure 5-2.

The production of laser light requires material (typically a rare earth element) in the active medium to be raised from its ground state to an excited state, creating a population inversion. Normally, atoms in the active medium reside in their ground states, and some external form of energy must be added to raise these atoms to an excited state. In a fiber laser, laser diodes typically provide this external energy. The process of creating a population inversion in the active medium is called pumping.

As Figure 5-3 shows, fiber lasers can use multiple diode lasers to perform pumping. The exact number of diode lasers depends on the application of the fiber laser and the output power required. In general, the more diode lasers providing pump energy, the greater the power of the fiber laser output beam. As Figure 5-3 shows, the output of each diode laser is transmitted by optical fiber to a multimode coupler. At the coupler, all the individual diode laser inputs are combined into a single light beam. The energy of this beam is equal to the sum of the energies being emitted from each diode laser, minus some small coupling losses, and is used as the pumping source for the fiber laser.

Once all the individual diode laser outputs are combined into a single beam, the beam is injected into the inner cladding of the fiber laser at an angle that ensures that total internal reflection occurs at the interface between the inner and outer cladding of the fiber laser. There are two conditions that must be met for this to occur. One condition is that the index of refraction of the medium in which the light beam is traveling must be greater than the index of refraction of the medium that the beam is moving toward. As Figure 5-2 shows, this condition is met as the pump beam travels from the inner cladding (n_{ic}) toward the outer cladding (n_{oc}), since $n_{ic} > n_{oc}$. The second condition is that the angle of incidence of the pump beam on the inner/outer cladding interface must be greater than the *critical angle*, which is given by the following equation:

$$\theta_{critical} = \sin^{-1}\left(\frac{n_{oc}}{n_{ic}}\right) \quad (5-1)$$

Total internal reflection ensures a minimum amount of light leaks from the inner cladding into the outer cladding. This means that most of the energy in the pump light will be available to raise the rare earth doping atoms in the fiber core to excited states.

Once the pump light undergoes total internal reflection at the inner/outer cladding interface, it is directed toward the core of the fiber laser. When this reflected pump light reaches the inner cladding/core interface, the majority (>90%) of it is transmitted into the core, where it interacts

with the rare earth doping atoms and raises them to excited states. The transmitted pump light that does not interact with atoms in the core exits the core on a path parallel to the path of the light that entered the core. This exit path allows the pump light to again undergo total internal reflection at the inner /outer cladding interface, thus redirecting it back toward the core. These processes of total internal reflection and transmission at the different interfaces continue down the entire length of the fiber laser and provide a mechanism for distributing the pump energy along the full length of the active medium. Figure 5-4 illustrates the path of the pump light inside the inner cladding and core.

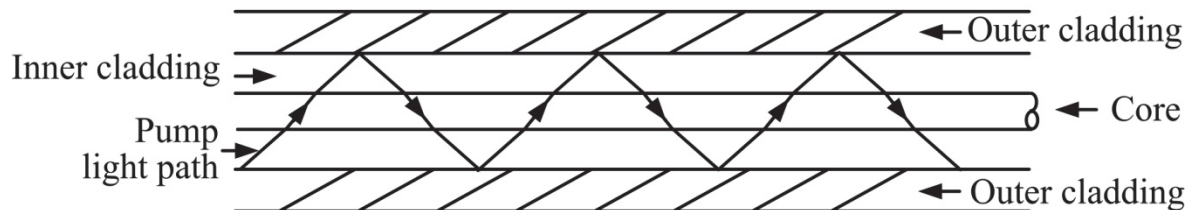

Figure 5-4 Propagation of light along the inner cladding of a fiber laser

In Figure 5-4, total internal reflection occurs at the inner/outer cladding interface. The bending of the pump light as it enters and exits the inner cladding/core interfaces is due to refraction.

The pump light transmitted into the core of the fiber provides the energy to initiate laser operations. As pump light is transmitted across the inner cladding/core interface, it interacts with the atoms in the fiber. Of particular interest is the interaction that occurs with the rare earth atoms (see Table 5-1) used to dope the core. When pump light interacts with these atoms, it raises them to higher energy levels, eventually generating a population inversion. Some of these excited atoms quickly drop to lower energies through fluorescence, creating within the core photons that have energies equal to the energy difference between the excited and lower-energy states in the rare earth atoms. These photons then move through the core and cause other rare earth atoms to drop to their lower energy levels through stimulated emission. As this stimulated process continues, the core becomes saturated with photons that are coherent with one another, have the same wavelength, and as a group are highly collimated—all of which indicates the generation of laser light. As this light approaches the ends of the core, it interacts with two mirrors (the three types previously described). One mirror fully reflects the light back into the core, causing more stimulated emission to occur. The second mirror partially reflects this light back into the core and allows a portion to be transmitted outside the core. This transmitted light constitutes the laser output. As long as the pump beam continues to transmit energy into the core, laser operation will be sustained.

Master Oscillator Power Amplifier (MOPA)

The master oscillator power amplifier (MOPA) configuration for lasers uses a relatively small, relatively low power laser to generate laser output. This output is then sent to an amplifier, which increases the power significantly. The reason for this configuration is that the original low-power beam can be generated with high beam quality in a single transverse mode. The beam quality is preserved in the amplification process.

In the past, MOPAs were used for many types of lasers. Now, they are employed to generate high power in fiber lasers. For cases in which the amplifier stage is a fiber, they are sometimes called a *master oscillator power fiber amplifier* (MOPFA). In the MOPFA, the master oscillator

portion is a fiber laser with end mirrors. The power amplifier portion is essentially a laser without mirrors. Figure 5-5 shows a typical arrangement. This figure shows a single stage of amplification. It is possible to add one or more additional stages as requirements dictate.

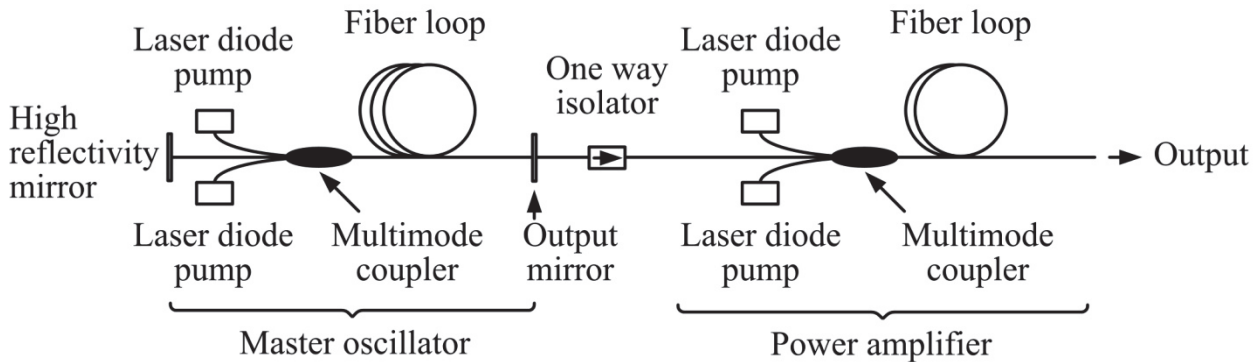

Figure 5-5 Schematic diagram of a core-pumped fiber MOPA

With amplification like this, it is possible to significantly increase the power while preserving single-mode operation. Also, because the fiber core is small, the power density is very high.

Fiber MOPA lasers have been widely used with Q-switched operation. This is because optical nonlinear effects can limit the power available from pulsed fiber lasers. Typical output parameters available from pulsed-fiber MOPA lasers are peak power around 40 kW and pulse duration in the nanosecond range.

Pulsing Methods

Fiber lasers may be operated CW or pulsed in a variety of ways, producing pulses with a wide variety of durations, ranging down to the femtosecond (10^{-15} s) realm.

Pulsing the Pump Source

The simplest method of pulsing a fiber laser is to pulse the laser diodes that pump the fiber, modulating the diodes on and off. Millisecond duration pulses are easily produced. Because the rise time of the diode sources is around 5 μ s, the minimum pulse duration obtainable with this method is about 10 μ s. Pulse repetition rates up to 50 kHz have been demonstrated.

Q-Switching

Fiber lasers have been operated as Q-switched lasers. Q-switching involves inserting a switchable device in the laser cavity that initially has high loss and prevents the laser from operating. Then the loss of the device is quickly switched off, and the laser can emit a short, high-power pulse. Figure 5-6 shows one arrangement for a Q-switched fiber laser.

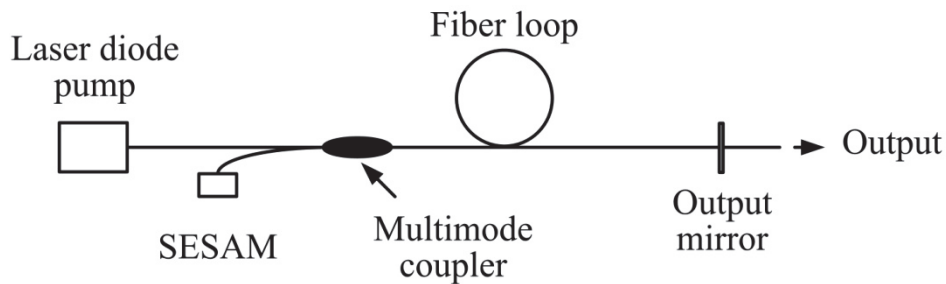

Figure 5-6 Simple design for a Q-switched fiber laser

This figure shows the Q-switch as a SESAM, described earlier in the section on mirrors. The Q-switch can take other forms—for example, it can be an electro-optic device, an acousto-optic device, or a saturable Bragg reflector. The highest values of power from Q-switched fiber lasers have been obtained with ytterbium-doped fibers at a wavelength of 1070 nm. Characteristics of Q-switched fiber lasers have included average powers up to 500 W and peak powers up to 1 MW, with pulse durations usually in the tens to hundreds of nanoseconds. Pulse energies can range up to 50 mJ.

Mode Locking

Mode locking of lasers is used to produce pulses with short duration, down to the femtosecond realm. A laser produces mode locked pulses when there is a fixed phase relationship between the modes in the resonant cavity. Interference between these modes produces a train of pulses of very short duration. Mode locking of lasers has been practiced for decades and has produced pulses shorter than one femtosecond in experimental situations. Commercial models of lasers with pulse durations of a few tens of femtoseconds are available.

Both passive and active techniques have been used to produce mode locking. Active mode locking is accomplished by introducing an external signal into the laser cavity to modulate transmission within the laser cavity. Devices such as electro-optic and acousto-optic modulators have been used. In passive mode locking, no external signal is used. The light in the laser cavity causes some change in the properties of the cavity like saturating an absorber as described previously.

Passive Mode Locking

In passive mode locking, a saturable absorber absorbs light of low intensity and prevents the laser from operating. If the intensity increases, the saturable absorber bleaches and transmits light. In a laser with multiple modes, there will be some intensity fluctuations. The higher-intensity portion of the fluctuation will partially bleach the absorber and allow more of the light to pass through. As the light in the cavity bounces back and forth between the mirrors, the higher-intensity portion is selectively amplified. Many passes back and forth between the mirrors lead to mode locking. The result is a train of short pulses spaced in time by the round-trip transit time of the laser.

Semiconductor saturable absorption mirrors (SESAMs), described above, have been used for passive mode locking of fiber lasers. For many years, SESAMs have been used for mode locking of various lasers. In recent times, SESAMs have been used in fiber lasers to reduce pulse durations and to increase average powers, pulse energies, and repetition rates for ultrafast

devices. The operating parameters of SESAMs can be varied over a wide range of values by varying the growth properties of the semiconductor layers.

Figure 5-7 shows a simple schematic diagram of a passively mode locked fiber laser using a SESAM as the saturable absorber and as a mirror. Such passive mode locking makes these lasers easier to operate than actively mode locked lasers. This is an advantage because no external clock signal is needed.

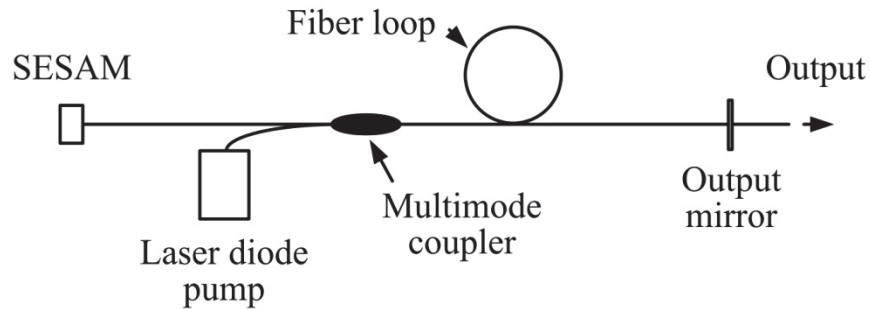

Figure 5-7 Simplified schematic diagram of a passively mode locked laser using a SESAM. The configuration is basically the same as that of Figure 5-6 for Q-switching.

Such passively mode locked fiber lasers can produce pulses as short as 80 femtoseconds. The pulse-repetition rates are fixed by the round-trip transit time of the cavity and depend on the cavity length. They may be as high as 100 MHz.

In addition, a material called *graphene* placed in a fiber laser cavity can act as a saturable absorber and produce passive mode locking. Graphene is a planar sheet of densely packed carbon atoms; the sheet is one atom thick. The optical absorption of graphene can be saturated by light in the visible and near infrared portions of the spectrum. Compared to other materials, it has a smaller loss before saturation and can be switched from absorbing to transmitting very rapidly. A graphene saturable absorber has been used in an erbium-doped fiber laser.

Active Mode Locking

Active mode locking is accomplished by modulating the gain of the laser cavity at a frequency equal to the reciprocal of the round-trip transit time of the cavity. This is frequently done with an active device such as an electro-optic or acousto-optic modulator. The period of the modulation must match the period of the laser cavity very closely. A train of short laser pulses is formed so as to be in phase with the modulating signal.

Active mode locking is more complicated than passive mode locking because it requires an additional operating device within the laser cavity and also an external modulating signal. Additionally, it does not provide pulses as short as those produced by the passive technique. However, active mode locking can provide higher pulse-repetition rates than passive mode locking techniques.

Both actively and passively mode locked fiber lasers are commercially available. Devices with pulse duration around 100 to 500 femtoseconds are fairly common, although some with pulse duration around 25 femtoseconds are available. Pulse-repetition rates up to hundreds of MHz with average power of tens of milliwatts are easily available.

Output Characteristics of Fiber Lasers

Range Of Wavelengths

Basic Wavelengths

Fiber lasers operate at a wide variety of wavelengths, which are determined primarily by the rare earth element with which the fiber is doped (see Table 5-1). As the table shows, the ranges of output wavelengths for these rare earth elements are very small. As a result, fiber lasers can be tuned for specific laser output wavelengths by using optical elements in their cavity that are designed to operate at these specific wavelengths. For example, for an ytterbium-doped fiber, the wavelength may be varied from about 1030 to 1100 nm. Many of the higher-power fiber lasers use ytterbium-doped fiber at a wavelength near 1070 nm. For CW fiber lasers, commercial models are available with wavelengths varying from 514 nm to 2100 nm. Pulsed fiber lasers are commercially available with wavelengths varying from 266 nm to 2000 nm.

Tunability

Fiber lasers have output spectra usually some tens of nanometers wide. These lasers can be made to operate anywhere within this range. The laser may be constructed to operate on only one narrow fixed wavelength band within the output spectrum. That wavelength can be chosen by adjusting the properties of the components that make up the laser—for example, by using multilayer dielectric mirrors, which are highly reflective only at the chosen wavelength. But once the laser is constructed, that wavelength cannot be changed.

Often it is desirable to have tunability over much of the output spectrum of the rare-earth-doped material—perhaps 100 nm or more. This is especially important for applications in communication, which frequently employ erbium-doped fiber lasers operating at a wavelength near 1550 nm, the same wavelength now used for most fiber-optic communications systems. In one example of tuning a fiber laser in this spectral range, a single-frequency erbium-doped fiber laser was tuned over a wavelength range greater than 40 nm, from less than 1525 to more than 1560 nm. This tuning was done using acousto-optic frequency shifters driven at RF frequency. The variation of wavelength with RF frequency was near linear. Stable single-frequency operation was demonstrated. In a second example, a mode-locked ytterbium-doped fiber laser was tuned over the range of 980 to 1070 nm. The laser cavity incorporated a pair of diffraction gratings, which acted as a dispersive delay line. The tuning was performed by rotating the high-reflectivity mirror, which was located next to the pair of gratings. This was a mode locked fiber laser with pulse duration in the picosecond range. In still another example, a double-clad thulium-doped silica laser was tuned by using a diffraction grating contained in an external cavity. The laser was pumped through the cladding by two diode laser bars at 787 nm. The fiber laser was tuned over a wavelength range from 1860 to 2090 nm. It produced a maximum output power of 7 W at 1940 nm, with 40 W of incident diode power.

These few examples, out of many possible, demonstrate the capability of tuning fiber-laser wavelengths over ranges from tens to hundreds of nanometers. They also show that such tuning may be achieved using a wide variety of techniques.

Frequency Doubling

It is possible to double the frequency of a laser (i.e. halve its wavelength) using nonlinear optics. Frequency doubling of laser light has been used for many different types of lasers and provides

useful laser output at otherwise unavailable wavelengths. With proper design, frequency doubling can be very efficient, so that most of the original light energy can be converted to the new frequency.

For fiber lasers, most of whose wavelengths lie in the infrared range, frequency doubling can provide output in the visible or even ultraviolet portions of the spectrum. For example, a neodymium-doped fiber laser operating at 1064 nm can be frequency doubled to emit in the green range at 532 nm. It has also been demonstrated that a neodymium fiber laser with a lithium triborate crystal as the nonlinear material can generate frequency-doubled green light with 84% conversion efficiency. It should also be possible to frequency triple and frequency quadruple this light to yield ultraviolet output at 355 and 266 nm. To achieve high enough intensity for efficient frequency doubling, the fiber laser is operated in a short-pulse mode. Typical values for the output of available frequency-doubled fiber lasers are pulse durations around one nanosecond, peak power up to 15 kW, average power up to 10 W, and pulse repetition rates up to 600 kHz.

Beam Divergence Angle

Single-mode operation provides the smallest beam-divergence angle, so there is considerable interest in having a fiber laser operate in only one mode. The minimum beam-divergence angle is set by the effects of diffraction at the aperture from which the beam diverges, which for fiber lasers is generally the diameter of the core. The minimum diffraction-limited beam-divergence angle θ is given approximately by the equation:

$$\theta = \lambda/d \quad (5-2)$$

where λ is the wavelength and d is the diameter of the aperture. The beam divergence angle is in radians.

As an example, for a single-mode ytterbium-doped fiber (emitting at 1070 nm) whose core is 50 μm in diameter, the beam divergence angle will be $1070 \times 10^{-9} \text{ m} / 50 \times 10^{-6} \text{ m} = 0.021$ radians, or about 1.2 degrees. This minimum diffraction-limited beam-divergence angle is attainable only for single-mode lasers. As output power becomes high, the output will contain higher-order modes, and the beam-divergence angle will increase. Many commercial CW fiber lasers have beam-divergence angles of a few milliradians.

Advanced Structures

The simple structures described near the beginning of this module were the original ones used and have been the basis for many of the fiber lasers in use today. But to improve the properties of fiber lasers, a variety of more advanced structures are now being developed. This section describes some of them.

Double-Clad Fibers

Double-clad fibers were discussed earlier in this module. But recently, they have been developed to improve fiber performance. In some cases, the output from the pump laser diodes does not match the spatial shape of the cylindrical double-core fibers described above. An example is a pump source consisting of a linear bar of laser diodes. For these pump sources, the

use of an asymmetrically shaped inner clad increases the chance of the pump light entering the core area, causing a greater population inversion. In such cases, one uses an elliptical, D-shaped or rectangular-shaped inner clad.

In many cases, the fiber is chosen to allow only single-mode operation. This makes it possible to obtain the smallest possible beam-divergence angle. Double-clad fibers are becoming widely used for high-power applications.

Chirally Clad Cores

Fiber lasers are used for micromachining applications, in which high average single-mode power is needed in short pulses (nanosecond regime). Fiber lasers are desirable for such applications, but have been limited by the power available in single-mode operation. To increase the power, it is necessary to increase the size of the core. One solution is the use of what is called a chirally clad core. This concept is illustrated in Figure 5-8. There is a central core with a large diameter. It is surrounded by a smaller satellite core (or perhaps more than one satellite core) wound in a helix around the central core. Higher-order modes get coupled into the satellite cores and have high losses, causing them to be scattered into the cladding. This results in only the lowest-order fundamental mode propagating through the central core.

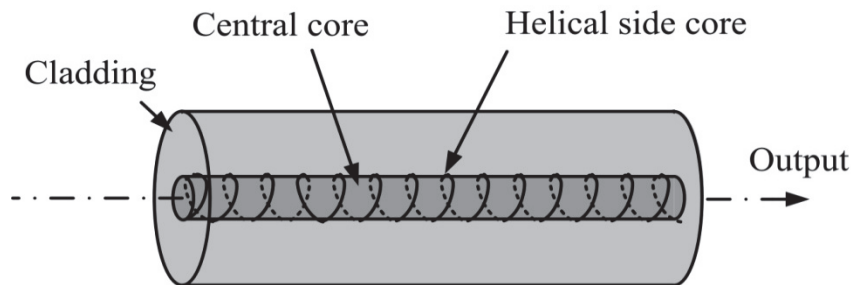

Figure 5-8 Structure of chirally clad core

The helical structure is formed by using a preform that has the central core and the smaller satellite core next to it, and both are aligned along the direction of the fiber. The fiber is drawn from the preform and is spun while it is being drawn. This leads to the structure shown in Figure 5-8. This procedure has produced fibers with high output power while preserving the high beam quality.

Large Mode Area (LMA) Fibers

There has been a continuing effort to increase the mode area of a fiber laser while retaining its ability to operate in a single mode (or at least only a few modes). This reduces the power per unit of area in the core, which in turn reduces the effect of the nonlinear optical processes that can degrade the laser output properties. It also reduces the probability of damage to the fiber by the high power density that is generated when one is producing pulses with high peak power and short duration. Fibers with larger core areas are called large mode area (LMA) fibers.

One approach has been to reduce the numerical aperture of the fiber. The numerical aperture (NA) is defined as:

$$NA = n \sin \theta \quad (5-3)$$

where n is the index of refraction of the cladding surrounding the core and θ is the half-angle of the maximum cone of light that can enter or leave the core. The NA defines the range of angles within which the core can accept or emit light. If one decreases the index of refraction of the core, the NA also decreases. But if the NA is decreased too much, the ability of the core to act as a waveguide also diminishes, leading to losses from the core. The numerical aperture can be reduced only to about 0.06 before problems with bend sensitivity begin to cause losses.

The output power of the laser can be increased by increasing the diameter of the core. But for an NA of 0.06, the core diameter cannot be increased to a value greater than about 25 μm without losing single-mode capability. There have been a number of approaches to obtaining single-mode output at larger mode areas. These designs use optimized refractive index profiles.

Fiber-Disk Lasers

The term *fiber-disk laser* denotes a fiber laser in which the pump light is delivered to the side of a coil of the fiber. In fiber-disk lasers, the pump light is not parallel to the active core of the optical fiber as it is in a conventional fiber laser. Rather it strikes a coil of the fiber from the side at an angle. The fiber is tightly coiled so as to form a small disk-like structure from large lengths of fiber. The angle is typically between 10 and 40 degrees. This approach allows more efficient use of the pump light, because for high power stacks of laser diode bars, the shape of the beam is not readily compatible with coupling into the end of a fiber.

The fiber-disk configuration allows efficient heat dissipation. The disk may be cooled with flowing water. The term *fiber-disk laser* is also applied to different configurations in which the fiber may be stacked, other than a circular coil. Any device with a stack of fibers pumped from the side is called a fiber-disk laser. The disk concept allows a long length of fiber to be pumped effectively by high-power laser diode sources. Also, it can reduce the space that fiber lasers require. It may be used when a fiber laser with large power output is desired. Fiber-disk lasers are used for applications that require high continuous power, such as welding or cutting of metal.

Raman Fiber Lasers

Some fiber lasers have been constructed so as to use the Raman effect to obtain different wavelengths. The Raman effect (or Raman scattering) occurs when light is scattered from a molecule with a change in frequency. The molecule undergoes a transition from one energy level to another. The difference in energy of the molecular energy levels is added to or subtracted from the energy of the photon. Thus, the wavelength of the light can either increase or decrease.

To maximize the Raman scattering in a fiber laser, the fiber may be doped with materials having appropriately spaced energy levels. Typically, relatively long fibers are used so that the Raman scattering can build up. Raman fiber lasers have been constructed with continuous tunability over a range from 1200 to 1600 nm. Raman fibers with laser output in the middle infrared have also been developed. Output power in the range from a few watts to a few tens of watts is typical. There has been interest in Raman fiber lasers for communications applications. They

have also been considered as pump sources for other fiber lasers, especially erbium-doped fiber lasers.

Fiber Laser Applications

Although they are still fairly new and are still developing, fiber lasers already have many established applications in such areas as communications, spectroscopy, medical technology, and the military and are being investigated for many others. Because the widest application of fiber lasers has been in materials processing (welding, cutting, etc.), it is useful to compare fiber lasers with other lasers that are commonly used in this area. Table 5-2 lists the established lasers used in material processing.

Table 5-2. Established Lasers Used in Materials Processing

Lasers	Wavelength (μm)	Power (W)
Repetitively pulsed Nd:YAG	1.06 (peak)	150,000
CW Nd:YAG	1.06	up to 5000
Repetitively pulsed CO ₂	10.6	> 1000 (average)
CW CO ₂	10.6	up to 30000
CW laser diode stack	0.9-0.98	up to 10000
CW disk laser	1.03	up to 16000

The values given in the table for power are not the highest ever achieved but instead represent what is commercially available. The values are for multimode operation; the single-mode values are lower. Also, the values of power for pulsed lasers are for pulses with durations in the millisecond range, since these durations are those most often used in materials processing. Other shorter pulses are available and may be used in other applications.

CO₂ lasers, Nd:YAG lasers, semiconductor diode lasers, and disk lasers use very different materials as lasing media. CO₂ lasers are gas lasers that use CO₂ as the lasing medium. A gas mixture containing CO₂ is excited by an electrical discharge through the gas. Nd:YAG lasers are solid-state lasers that use the rare earth element neodymium implanted in a crystal of yttrium-aluminum-garnet (YAG) as the lasing medium. They are excited optically by light from flashlamps, arc lamps, or laser diodes. As explained above, semiconductor diode lasers are p-n junctions in semiconductor materials, such as aluminum gallium arsenide, and are electrically excited. To produce high values of output power, many diode lasers are fabricated in a bar shape, and the bars are then arranged in stacks. Disk lasers use a thin disk of a solid-state active material, often ytterbium-doped YAG (Yb:YAG), which usually emits in the near infrared. The disk is in close contact with a heat sink. It is pumped from the side by semiconductor diode lasers.

CO₂ lasers emit at an infrared wavelength of 10.6 μm. Nd:YAG, semiconductor diode lasers and disk lasers emit in the near infrared near 1 μm. Because of these different wavelengths, some materials are better absorbers for the different laser beams. Most metals are reflective at wavelengths near 10 μm. Thus, it requires more power to melt or vaporize metals with a CO₂

laser than with any of the other shorter wavelength types. Still because of the higher power available, CO₂ lasers can be very effective for welding or cutting metal.

The different lasers produce different beam shapes. The beam divergence angle θ is given in Equation 5-2 and repeated here:

$$\theta = \lambda/d \quad (5-2)$$

Where λ is the wavelength and d is the diameter of the aperture from which the beam emerges. Because the wavelength of the carbon dioxide laser is about 10 times larger than that of the other types of lasers, the beam-divergence angle is larger. This is partially compensated by the fact that the exit aperture of the CO₂ laser can be made larger. Conversely, the exit aperture of a semiconductor laser diode is very small so that its beam divergence angle will be large. This must be corrected by the use of optics. The beam-divergence angle of the Nd:YAG laser and the disk laser are similar and are smaller than those of the carbon dioxide and semiconductor lasers.

Advantages of Fiber Lasers

Compared with other, competing lasers, fiber lasers offer many advantages.

High Efficiency

Fiber lasers offer higher efficiency than other lasers used for similar applications, such as the Nd:YAG laser and the carbon dioxide laser. The efficiency is the fraction of the electrical power input that emerges as laser-power output. For Nd:YAG lasers, the efficiency is around 2%. For carbon dioxide lasers, it is often in the 15–20% range. For fiber lasers, it is usually in the 25–30% range. Also, there is less energy needed for purposes other than pumping the laser—for example, for cooling and circulating gas.

Output Power

CW Power

Recent advancements have caused the CW power available from fiber lasers to increase significantly. Developments that have allowed fiber-laser power to be scaled to higher values have included large mode area (LMA) fibers (discussed earlier) and higher-power pump laser diodes. The CW power that can be obtained from ytterbium-doped fibers has reached 10 kW in single-mode operation and more than 50 kW in multimode operation. Many commercial models with CW-power output in the range of tens to hundreds of watts are available.

Pulsed Power

The types of fiber lasers that have high values of peak pulsed power include Q-switched fiber lasers and mode locked fiber lasers. The peak power of Q-switched fiber lasers ranges from kilowatts to megawatts, with pulse duration in the range of tens to hundreds of nanoseconds. Pulse-repetition rates can be as high as hundreds of kilohertz. For mode locked fiber lasers, pulse durations range from picoseconds down to femtoseconds. At these very short pulse durations, peak power can be extremely high. Even for 1 mJ of output energy, at 100 fs, the peak power can be around 10 GW. Pulse-repetition rates can range up to more than one hundred MHz.

High Brightness

Brightness (power per unit area per unit solid angle, also called radiance) can be very high in a single-mode fiber laser. Brightness is usually given in units of watts per square centimeter per steradian, where a steradian is a unit of measurement of solid angles. Irradiance (power per unit area at a surface) is another term that is often used to describe laser brightness.

The area of the beam as it emerges from the fiber is that of the fiber core, which is small and in single-transverse-mode operation, the angular spread of the beam is at a minimum. This means that the brightness is very high.

Example 1

A single-mode fiber laser emits 100 W CW at a wavelength of 1070 nm. The core diameter of the fiber laser is 50 μm . The irradiance (E) of this laser at the end of the core is given by

$$E = 100\text{W} / \left(\frac{\pi(50 \times 10^{-4} \text{ cm})^2}{4} \right)$$

$$E = 5.1 \text{ MW} / \text{cm}^2$$

According to Equation 5-2, the beam divergence angle is:

$$\theta = \frac{\lambda}{d} = \frac{1070 \times 10^{-9}}{50 \times 10^{-6}} = .0214 \text{ radians}$$

The solid angle for very small values of θ is given by:

$$\Omega = \frac{\pi\theta^2}{4} = \frac{\pi}{4} (.0214)^2 = 3.6 \times 10^{-4} \text{ steradians}$$

The brightness is

$$L = \frac{E}{\Omega} = \frac{5.1 \text{ MW} / \text{cm}^2}{3.6 \times 10^{-4} \text{ steradians}} = 14179.3 \frac{\text{MW}}{\text{cm}^2 \text{ steradians}}$$

$$L = 14.2 \frac{\text{GW}}{\text{cm}^2 \text{ steradians}}$$

When the beam emerges from the fiber, it may be easily collected with a lens and focused to a very small spot—a factor important for materials processing.

Excellent Beam Quality

In laser science, a parameter defining the quality of the laser beam is denoted M^2 . This parameter is defined as the ratio of the divergence angle of the beam to the beam divergence angle of the lowest spatial mode (the Gaussian mode) with the same aperture located at the same position. For a pure Gaussian beam, this ratio is obviously unity. If there is a small mixture of

higher-order modes, the value of M^2 will be slightly greater than unity, and if there are many high-order modes in the beam, the value of this parameter will be much greater than unity.

Fiber lasers operating at relatively low power generally have small values of M^2 —often less than 1.1. This means that the quality of the beam is excellent. In general, as the power of the laser increases, the value of the beam-quality factor also increases. But because of the nature of the fiber laser, with the beam generated in a fiber, the increase in M^2 with power is less than it is in most other lasers. Single-mode fiber lasers have been fabricated with values of M^2 remaining near unity at fairly high values of power. Q-switched fiber lasers have M^2 values near unity for pulses with 1 mJ of energy and M^2 values near 40 for pulse energies near 50 mJ.

Beam quality is important for many applications. In fiber-optic communications, beams must have M^2 close to 1 in order to be coupled to a single-mode optical fiber. In laser materials processing, small values of M^2 are required in order to focus the beam to a small spot. This gives fiber lasers an advantage over other lasers for these applications.

Low Operating Cost

Because higher efficiency leads to less use of electricity, and because there is little maintenance required and no use of gas in the laser, the operating cost of fiber lasers is lower than that of competing lasers. According to one estimate, at the 4 kW level, the operating cost for a fiber laser is about \$12 per hour for 8 years of use. This estimate includes electricity, maintenance, replacement parts, gas, and depreciation and interest on the original purchase. In comparison, under the same conditions, the operating costs of CO₂ lasers and Nd:YAG lasers were estimated to be about \$24 per hour and \$38 per hour, respectively.

Low Maintenance

There are no periodic maintenance tasks to be performed. There is no mirror adjustment or replacement and no regular pump-source replacement. There are no blowers or gas supplies, and there are no moving parts. In contrast to competing lasers used for materials-processing applications, such as carbon dioxide and Nd:YAG lasers, fiber lasers do not require preventative maintenance. Users may need to service output optics and coolants, but otherwise, a fiber laser will perform consistently without adjustment or other servicing. These low maintenance requirements are one important contributor to the low operating costs mentioned above.

Long Lifetime

A fiber laser's operating lifetime is determined by the lifetime of its diode laser pumps, which is estimated to be 100,000 hours. This is much greater than the operating lifetimes of Nd:YAG lasers and carbon dioxide lasers.

Reliability

The manufacturers of commercial fiber lasers claim very high reliability for their products. Their claim is that fiber lasers will operate continuously, 24 hours per day, for decades. This claim is based on the simplicity of fiber lasers and on the fact that they have no components that degrade or require periodic maintenance.

Easy Coupling into Fibers

Because the beam emerges from the end of the core of a fiber, it is very easy to direct it into the end of another fiber using the well-known techniques of simple bonding or end-to-end compression.

Compact Size

Fiber lasers can be contained in very small spaces. For example, one commercial ytterbium-fiber model emitting 100 W—high enough for welding and cutting—is contained in a rack mount 66 X 44.8 X 26.6 cm (26 X 17.6 X 10.5 in). This is much smaller than would be possible with a CO₂ or Nd:YAG laser. Thus, for applications such as materials processing, use of a fiber laser can save valuable factory-floor space, reducing the amount of area that needs to be rented, heated, and cooled.

Future Prospects

Fiber laser capabilities are expected to continue to advance, with commercially available power levels reaching 100 kW or more. The beam quality should continue to improve, and the power levels available in single-mode operation should also increase. The output power available at the wavelength of 1.54 μm, useful for telecommunications, will increase to the kilowatt level. The cost for fiber lasers is expected to decline further, making them even more competitive with other lasers. In summary, these advances will help expand the applications of fiber lasers to more industries.

Applications in Materials Processing

Materials processing is the area that has developed the most applications for fiber lasers. These applications include welding, cutting, micromachining, marking and engraving, and wafer processing.

Welding

Welding applications may be performed in two different ways: conduction welding and penetration welding.

Conduction Welding

Conduction welding is performed by delivering the laser beam to a small area on the surface of the work piece. The laser energy is absorbed at the surface. The energy heats the surface to a high temperature so that a thin layer near the surface is melted. Energy is carried into the interior of the material by thermal conduction. This in turn melts the material to some depth. The depth z to which the energy penetrates in time t is given approximately by:

$$z^2 = 4\kappa t \quad (5-4)$$

where κ is the thermal diffusivity of the material. Thermal diffusivity is a material parameter that has dimensions of cm²/s and describes how thermal energy diffuses through a material. The higher the value of thermal diffusivity, the greater the depth melting occurs in a given time.

Example 2

The depth of energy penetration for a 10 ms laser pulse striking a stainless-steel surface can be calculated using Equation 5-4:

$$z^2 = 4\kappa t \quad \kappa \text{ for stainless steel is } .04 \text{ cm}^2/\text{s}$$
$$z^2 = 4 (.04 \text{ cm}^2/\text{s})(.010 \text{ s}) = .0016 \text{ cm}^2$$
$$z = .04 \text{ cm}$$

Thus, conduction welding is limited to relatively thin material samples.

The earliest uses of lasers for welding involved conduction welding and were carried out with pulsed lasers or with continuous lasers whose power was below the 1000–1500 watt range. Very early in the history of lasers, it was demonstrated that conduction welding could produce high-quality welds with small heat-affected zones and with full strength (that is, tensile strength as high as that of the original material).

Penetration Welding

In a different welding procedure, called penetration welding, the laser delivers higher irradiance to the surface. The beam vaporizes some material, producing a hole in the material, and energy is delivered to the bottom of the hole. This requires an irradiance of around 10^6 W/cm^2 . In penetration welding, the energy is delivered throughout the depth of the material. Thus, the depth is not limited by thermal conduction from the surface, and it is possible to weld to much greater depths. Penetration welding is also sometimes called deep-penetration welding or keyhole welding. Usually, multi-kilowatt lasers are used for penetration welding. Fiber lasers have been used for both conduction welding and penetration welding.

Welding Results

Fiber lasers are effective in welding applications. Many published papers have demonstrated their effectiveness, and some of the applications described in these papers have been transferred to production. Most of the welding applications of fiber lasers have involved ytterbium-doped fibers operating near 1070 nm, because these lasers can emit the highest values of power. Figure 5-9 shows a typical arrangement for welding applications. The mirrors for the fiber laser are shown as distributed Bragg reflectors, described previously. The figure also shows the beam transmitted through a transmitting fiber to a remote work piece.

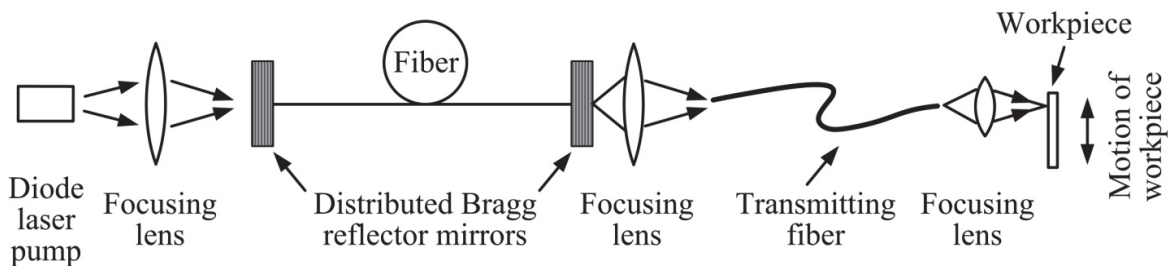

Figure 5-9 Typical arrangement for welding with a fiber laser

Fiber lasers have been used in the conduction mode for welding razor blades, diaphragms for medical devices, cases for pacemakers, and other thin samples. The power needed for such welding has usually been in the range of some hundreds of watts. One study demonstrated conduction welding of stainless steel by a continuous ytterbium-doped fiber laser emitting 360 W at a wavelength of 1070 nm. Welds from this laser could be made at a speed of 50.8 mm/s and have reached a depth of 0.89 mm. Conduction welding of 0.5 mm thick stainless steel at 1 meter/minute has also been demonstrated with only 100 watts of fiber-laser power.

Because fiber lasers are now available with multi-kilowatt output power, they have also been used to make deeper welds in the penetration mode. A study compared the depth of penetration welds in mild steel as a function of welding speed at the 3.5 kW level for fiber, CO₂, and Nd:YAG lasers. The study covered the range of weld speeds from 1 to 10 m/minute. At all weld-speed values except the very lowest (< 1.5 m/minute), the fiber laser produced the greatest welding depth.

In a test of penetration welding of stainless steel with 6 kW of fiber-laser power at a wavelength of 1070 nm, the welding conditions (focus and weld speed) were varied. A fairly broad region of weld parameters was found in which the welds were sound, with no porosity or other defects. The maximum depth in which this no-defect welding could be produced was around 7 mm. These results demonstrate the ability of fiber lasers to produce high-quality welds.

Fiber lasers have also made high-quality welds in aluminum. Welding thick aluminum has been difficult with other lasers. The high reflectivity of aluminum near 10 μm makes the CO₂ laser a poor choice. Nd:YAG lasers have frequently been used in the automotive industry, but their lower CW power has limited the throughput. In contrast, butt and overlap welds have been made in aluminum 6 mm thick with a 7 kW ytterbium-doped fiber laser. With the beam focused to a 0.5 mm spot, welds could be made at a speed of 3 meters per minute. The welds had complete penetration and were of excellent quality, with very few defects and a narrow fusion zone.

Materials that have been welded with ytterbium-fiber lasers include stainless steel and other types of steel, titanium and aluminum alloys, and Inconel (a nickel alloy). Applications include butt welding titanium panels, conduction welding of diaphragms, full-penetration welding of transmission gears and shaft assemblies, and welding of thick steels.

The beam quality of single-mode fiber lasers allows it to be focused to a very small spot size, generating high irradiance at the target surface, and producing excellent quality welds.

Cutting

Lasers have long been used for cutting—for example, the automotive industry uses lasers to cut metals. The laser of choice—the one that has been used most often—is the carbon dioxide laser, which is often used at a multi-kilowatt level. Now, fiber lasers with multi-kilowatt output are commercially available and are competing for metal-cutting applications. As an example, a study using a fiber laser emitting 400 watts of power at a wavelength of 1075 nm reported cutting rates around 2 m/minute for 2 mm thick stainless steel and about 6 m/minute for 2 mm thick mild steel. These cutting rates increased substantially as the sheet thickness decreased. The cut edges were of high quality, with little dross and small heat-affected zones.

Another study compared the cutting rates at 4 kW of power of a fiber laser and a carbon dioxide laser. The fiber laser cut relatively thin samples (1–2 mm) at speeds about 5 times faster than the carbon dioxide laser. For greater thickness (10 mm) the fiber laser cut about 1.3 times faster.

These results indicated that fiber lasers are viable candidates for sheet-metal cutting applications.

The manufacturer of one type of fiber laser combined a fiber laser with linear-motor axis drives to create a complete laser cutting system for sheet metal. They demonstrated that their system cuts maintenance costs by up to 40% compared with CO₂ laser cutting systems. They have also shown that their system can cut mild steel two to three times faster than CO₂ laser systems.

Effective cutting with fiber lasers has also been demonstrated for nonmetals, including plastics, acrylics, polycarbonate, and leather. Practical examples of cutting with pulsed fiber lasers include cutting silicon wafers for solar panels and stencil cutting. High-power multimode fiber lasers have been used for CW cutting of metals ranging from thin sheets to heavy plate for a variety of applications. The large depth of field and small spot size of fiber lasers lead to small kerfs and straight walls—even in thick metals. Common applications of high-power multimode fiber lasers include cutting automotive body parts such as hydroform tubes.

Micromachining

Lasers have found many applications in micromachining. They have been used to produce medical devices such as stents, to drill holes for microvias in circuit boards, to pattern thin films, and to repair semiconductor memories. These applications require high peak power for rapid material removal, short pulse length (nanosecond regime) for vaporization without producing a large heat-affected zone, good beam quality for focusing to a small spot, and high pulse-repetition rate for high volume production. Reasonably high average power is also desirable. Frequency-doubled or -tripled Nd:YAG lasers have dominated these applications for many years. But fiber lasers have all the properties listed above and are now a competitive option for this application.

Marking and Engraving

Lasers have long been used for marking products. They imprint product identification, barcodes, serial numbers, logos, etc. on metals, plastics, glass, stone, wood, and cardboard. The choice of laser for a particular application is determined by the laser's wavelength: the wavelength must be one the material requiring marking can absorb. CO₂ lasers have been used for materials such as plastics and wood, which have high absorption (near 10 μm), while Nd:YAG lasers have been used for metals, which are reflective in the far infrared.

Laser marking may be performed in several different ways. In a dot matrix format, the laser is repetitively pulsed, and between pulses, the beam is directed to different spots on the target so as to form an alphanumeric character. In another technique, the laser beam is spread over a broad area so as to strike a reflecting mask in which the desired pattern is defined by vacant areas. Using this technique, the entire pattern is formed in one laser pulse. Engraving is another way to mark materials. Engraving involves scanning a laser beam back and forth over the area to be marked while modulating the power to change the depth of material removed. Engraving may be used to form complex patterns such as company logos. Fiber lasers are well suited for any of these methods of marking. Because of their high beam quality, they may be focused to small spots, which is useful in dot matrix marking. Pulsed fiber lasers with high pulse energy are suitable for mask marking, since their diode pump lasers are easily modulated.

Marking by Q-switched fiber lasers with nanosecond pulse duration has been demonstrated for many materials, including glassy carbon, copper, silver, plastics, and polymeric materials. The high values of peak power available are important for such marking.

As an example of fiber-laser marking, a fiber laser with a beam scanning system included is being sold for applications in bar code marking of plastic components and metal tools and parts. The 24" x 12" area covered by the scanning system can contain one large part for processing or could hold many smaller parts to treat simultaneously.

Wafer Processing

Fiber lasers can be used in the semiconductor processing industry, particularly for cutting and dicing silicon or other crystalline wafers on which integrated circuits have been fabricated. Up till now, the semiconductor industry has typically used diamond saws to cut silicon. But diamond saws can cut only in straight lines and can cause problems with breakage. Other methods tend to be slow or expensive. The problems associated with cutting silicon wafers continue to grow worse as the density of circuits on them increases.

Silicon wafers can be cut using 200 watts of CW power from a 1075 nm wavelength fiber laser. For 1.4 mm thick silicon, the cutting rate was measured at 0.7 m/minute. The cutting rate increased for thinner samples, reaching speeds greater than 6 m/min for 0.5 mm thick samples. The cut edges were smooth with no cracking. Moreover, the fiber laser could cut in patterns other than straight lines. Commercial models of such equipment are available.

Also, there have been limitations on cutting and separating very thin (less than 100 μm) silicon wafers. The yield can be unacceptably low using conventional techniques. Laser cutting has been used, but the thermal effects cause a reduction in the fracture strength. An investigation of the cutting of 50 μm thick silicon wafers by 700 fs duration pulses of near infrared radiation from a fiber laser-amplifier combination showed smooth walls with very little debris when the wafers were processed at a high scan speed and a high pulse-repetition rate (500 kHz). Under the same processing conditions, the fracture strength of the cut wafers remained high. This was attributed to the very low heat effect that resulted from such short pulses. These findings could lead to use of fiber lasers for semiconductor processing in the future.

Other Applications

Although fiber lasers have widely been used for materials processing, many other applications have also been investigated. This section examines some of these other applications.

Telecommunications

Laser-based fiber telecommunications systems using fiber-optic links have been in widespread use since the 1970s. The laser source has most often been a semiconductor laser diode. Now, the fiber laser offers an alternative choice with these advantages:

- Erbium-doped fibers emit at a wavelength near 1550 nm, the wavelength that is most favorable for well-developed glass-transmission fibers. Such fibers have the lowest loss near that wavelength. Thus the erbium-doped fiber lasers have a very desirable wavelength.
- The emission from a fiber laser comes out of a fiber, so it is relatively easy to couple the light into a fiber for long-distance transmission. It is simple to join the laser fiber and the transmission fiber by fusion coupling. By contrast, when semiconductor diode lasers are used as sources, the light is emitted over a broader angle and is more difficult to couple into a fiber.

- For communication applications, a passively Q-switched fiber laser offers high pulse-repetition rates, up to at least 100 MHz. This is compatible with high data-transmission rates.
- Fiber lasers are very reliable and maintenance free.

With all these advantages, fiber lasers are becoming popular in the telecommunications industry, and their use will continue to grow. Figure 5-10 shows a possible fiber laser communications source. The fiber Bragg gratings are distributed Bragg reflectors formed within the end portions of the laser fiber. The laser fiber and the transmitting fiber are coupled end to end.

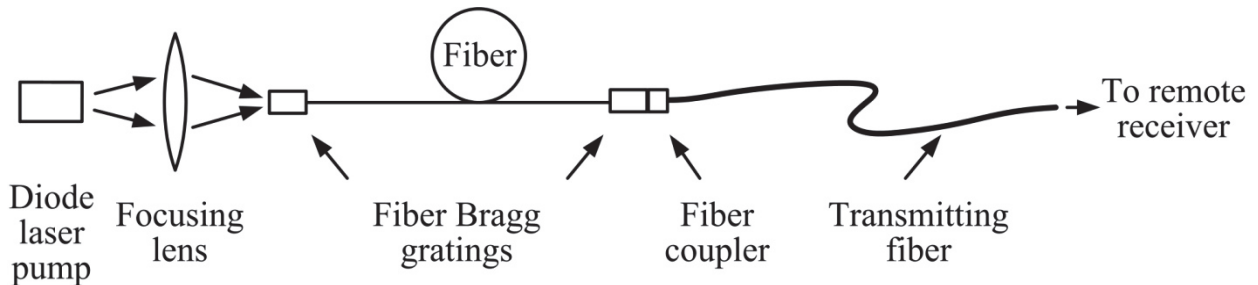

Figure 5-10 Conceptual design for a fiber laser communications source

Spectroscopy

Fiber lasers have been used in a variety of scientific investigations involving spectroscopic studies of atoms and molecules and more macroscopic objects including solids, liquids, and gases. Fiber lasers offer many advantages, including small size, portability, low maintenance, and reliability. Tunable titanium-doped sapphire lasers have been widely used for laser spectroscopy, but because of the same advantages mentioned for telecommunications, fiber lasers are becoming popular alternatives.

This popularity in spectroscopy is due to the fiber laser's ability to generate very short pulse lengths in the femtosecond range, which allows for high-speed studies of the dynamics of atoms and molecules. Also, the high peak powers available in the green portion of the spectrum (when a near-infrared fiber laser is frequency doubled) are widely used for Raman spectroscopy, which studies vibrational and rotational energy levels in materials. Of the many demonstrations of the use of fiber lasers in spectroscopy, we present only two examples. These are high-resolution remote spectroscopy and two-photon fluorescence spectroscopy.

In the first example, an erbium-doped fiber laser was used in a scientific study to measure remotely the absorption of an oxygen molecular band in the 760 to 770 nm region. The motivation for this research was to determine atmospheric oxygen pressure at a distance. The application required an efficient, rugged laser operating in a single mode with high peak power. No other laser fulfilled the requirements well, so a frequency doubled erbium-doped fiber laser was developed for this application. The beam was directed at a solid target, and after a 440 meter round trip, the researchers used a telescope to collect backscattered light that could be analyzed for oxygen. This experiment demonstrated successful remote oxygen sensing with a fiber laser and paved the way for longer path measurements.

The second example highlights a technique called *two-photon fluorescence spectroscopy*. This technique used a commercial fiber laser emitting pulses with length less than 150 fs at a

wavelength of 810 nm. Two-photon fluorescence spectroscopy involves absorption of two laser photons by the material under study and reemission by the material of a single photon of shorter wavelength. The spectrum of the shorter-wavelength light is analyzed to find the material's energy level structure. The fiber laser used in this technique was smaller and less expensive than the possible alternative laser, the Ti:sapphire laser. The measurements included the temporal decay of the fluorescence produced by the simultaneous absorption of two laser photons in some fluorescent dyes and yielded results as expected from theory. This scientific work showed that fiber lasers were effective tools for performing precise spectroscopy measurements and were viable substitutes for other lasers typically used in these analyses.

Medicine

Fiber lasers have a variety of applications in the medical field, including marking and manufacturing of medical devices and direct irradiation of the body. The following examples give details of these applications.

Fractional Resurfacing

Fractional laser resurfacing is a technique for rejuvenating skin. It has been used for treating age spots, freckles, wrinkles, and acne scars. Tiny spots are heat treated by the laser. In the treated areas, the old skin is replaced by new, healthy tissue. This treatment has been successfully demonstrated and is gaining popularity. There is one commercially available fiber laser designed for this treatment: an erbium-doped fiber laser emitting infrared radiation at 1550 nm. The laser radiation is delivered through a specially designed scanner to the skin targeted for resurfacing. The procedure must be controlled by a trained medical person skilled in the technique.

Marking Implants

Medical implants must be clearly marked for both tracking and identification. Methods such as using ink or dye are unsuitable to mark these devices because they may cause contamination or allergic reaction. Lasers are used to create permanent, contaminant-free marks with no surface distortion. Fiber lasers can be focused to very small spot sizes allowing the engraving of characters as small as 0.3 mm.

Marking Medical Devices

Marking of devices and components is a common process in the medical industry. Fiber lasers have found use in marking medical devices such as forceps and clamps through a material ablation process. But a new method called *dark marking*, which does not remove material, has been developed. This technique involves scanning the beam in a series of passes over the area designated for marking. Typically, the instruments to be marked are made of stainless steel, which oxidizes on the surface when heated. After a number of passes, the color of the surface changes. This produces a dark mark that is easily visible. The marks are stable and are not removed in the processes used to sterilize medical devices. Q-switched ytterbium-doped devices emitting laser radiation at a wavelength near 1070 nm are often used in medical marking. Typically, these lasers operate at 1 mJ with a pulse-repetition rate of 20 kHz and pulse duration around 400 ns.

Manufacturing Medical Components and Devices

The manufacturing of medical components and devices involves materials-processing procedures such as welding and cutting. The use of fiber lasers for these operations has been

described above, but here we discuss these processes particularly as they apply to the manufacture of medical devices.

Lasers have been used to weld surgical instruments made of expensive materials. These devices must be precisely fabricated to ensure that surgeons have the control they need to perform various medical procedures. The fiber laser can achieve tolerances down to dimensions of a few micrometers. Another advantage of fiber lasers is their ability to weld strong, smooth, hermetic seals. This is important because many components are permanently implanted into the human body. They must not degrade or corrode over time. Since surgical instruments must be sterilized, their hermetic joints must be free from pores, so that they may be sterilized in an autoclave without causing damage to the instrument. Hermetic seals formed by fiber lasers are also important in fabricating pacemakers and sealing electronic components associated with medical devices used in the human body. Fiber-laser welding also produces smooth, debris-free, clean welds without discoloration. This is the result of their highly controlled, localized heat input. The quality and good appearance of the weld are important factors for manufacturers of medical devices. Couple all these advantages with fiber lasers' low operating costs and low maintenance requirements, and it becomes obvious why manufacturers of medical components are increasingly using these lasers.

Fiber-laser cutting is important in the manufacture of surgical instruments and medical implants. Fiber lasers can cut many different materials with different thickness, ranging from thin foil 50 μm thick to metal sheets several millimeters thick. The high quality of the fiber-laser cuts result in kerf widths less than 20 μm . The heat-affected zone near the cut is very small, and the number of defects along the edge is very low. Cutting speeds of 10 m/min are possible in metals, ceramics, and semiconductors.

As an example, fiber lasers have been used in the fabrication of stents to be inserted into diseased coronary arteries to restore blood flow. The stents are similar to a woven metal mesh and are fabricated by drilling many small holes into a thin metal tube that is typically made of stainless steel and nickel alloys. The material removal must be extremely precise. Stents are fabricated from tubes with diameters between one and ten millimeters and with wall thickness around 100 μm . It is clear that this process requires a very controllable laser. Fiber lasers with a high-quality beam can provide this controllability, as well as a very small spot size. In one demonstration of the use of fiber lasers for stent manufacture, the cuts were made with a 100 W fiber laser. The cuts had high surface quality, no dross, a small heat-affected zone, and good appearance. In a comparison of fiber lasers and solid state lasers for stent production, the two types of lasers had similar rates of production, but the fiber lasers provided cleaner edges with less slag. In addition, the fiber lasers occupied less space, required less maintenance, and used less input power.

Microsurgical Applications

Fiber lasers are being considered for use in microsurgery because they offer the advantages of lower cost, low maintenance, high efficiency, and compactness. Unlike other lasers, they do not need an additional delivery fiber. In one experimental study, researchers used a 110 W thulium-doped fiber laser to vaporize prostate tissue. Another group of researchers is using ytterbium-, erbium-, and thulium-fiber lasers for studies of soft-tissue surgery in the areas of urology, dermatology, and ophthalmology. Still another group is studying the potential uses of an erbium-doped fluoride glass-fiber laser for microsurgical applications in ophthalmology and otolaryngology. So far, these investigations are all still in the research phase. But there is

enough interest in using fiber lasers for microsurgical applications that we may expect them to emerge into clinical use in the future.

Military Applications

The U.S. Department of Defense has exhibited substantial interest in fiber laser technology and is funding a number of research programs in this area. These research programs are not for weapons but rather for applications such as ranging, remote sensing, and security.

Ranging

Laser-based range-finding systems have long been available and have been widely used by the U.S. military. They operate by transmitting a short pulse of laser light and measuring the roundtrip time of the pulse from the laser to an object of interest. Since the velocity of light is a known constant, range finders can use it to determine the distance of the object. The small, portable laser range finders now used in the field have a maximum range of around 10 to 20 km and accuracy in the 1 to 10 m region. This accuracy is determined by the pulse duration, which in current systems is in the nanosecond range. Fiber lasers, which are compact and portable, can emit femtosecond-duration pulses with very high peak power. As a result, fiber lasers are now being seriously considered as replacements for the military's current ranging systems.

One demonstration has used an erbium-doped fiber laser operating at a wavelength of 1.55 μm . The detection system uses a beat frequency between the reflected light and a local reference signal. This system has reported range capabilities of up to hundreds of kilometers with accuracies of one meter or less. Moreover, at this wavelength, the rangefinder is eye safe. In another demonstration, a compact erbium-doped fiber laser has been developed for space and airborne light detection and ranging (LIDAR). This instrument uses kilohertz pulse-repetition rates and 300 W of power. It is intended for applications such as mapping terrain elevation and making remote measurements of atmospheric composition. This too is an eye-safe system.

Remote Sensing

Thulium-doped fiber lasers have been developed for remote gas sensing. Thulium-doped fiber lasers operate at wavelengths in the 1800 to 2200 nm region. This wavelength region contains spectral-absorption lines for many gases of interest, both for military applications and for industrial emission monitoring. In one application, the laser beam is transmitted to a fixed reflecting target and the strength of the reflected return signal is monitored. The laser is tuned over a spectral range containing absorption lines of the gases of interest. A reduction in the return signal at a specific wavelength can identify the presence and concentration of a given gas.

Security

Fiber lasers have been studied for their ability to detect and locate disturbances over long paths. This can provide enhanced security for military installations or for homeland security applications. One demonstration used a fiber laser co-doped with ytterbium and erbium that emitted at a wavelength of 1550 nm. The laser, operating CW, was frequency modulated, and part of the output was sent via fiber to a nearby fixed reflector. The reflected return served as a local oscillator. The rest of the laser light was sent through a long fiber which acted as the sensing element and was deployed over the area requiring monitoring. The light reflected from the sensing fiber and the light from the local oscillator were mixed generating a beat frequency. The beat frequency was proportional to the difference in time delay between the two signals. When the sensing fiber was disturbed, the beat frequency generated by the return signals

changed. The altered beat frequency was used to determine the distance from the laser to the disturbance.

If you require more information or greater detail on the applications presented in this module go to the OP-TEC website, www.op-tec.org, and review the modules in the Photonics-Enabled Technologies (PET) series. These modules cover a broad range of photonics applications in the following technology areas: manufacturing, biomedicine, forensic science and homeland security, environmental monitoring, optoelectronics, data storage and imaging, fiber-optic communication, and holography. You may request a download copy of a PET module through the OP-TEC website.

SAFETY CONSIDERATIONS

Most fiber lasers are Class 3B (5 mW to 500 mW) or Class 4 (500 mW or greater). Powers can be as high as 100 kW. Fiber lasers are tunable over a large range of wavelengths, but the majority are in the visible and infrared ranges. Visible wavelengths are generated using frequency doubling techniques.

Fiber lasers are a threat to both the retina (which is the worst scenario) and cornea of the eye. Damage to the retina occurs at wavelengths between 400 nm and 1400 nm (visible and near infrared). Damage to the cornea occurs at wavelengths between 1400 nm and 1 mm (mid- to far infrared). Because of this range of wavelengths, it is important for safety goggles to have the optical density (OD) appropriate for the selected operating wavelength of the laser.

Typically, safety goggles with an OD of 6 at fiber laser wavelengths are suitable for protecting the retina and cornea. However, considering the multiple output wavelengths emitted by a fiber laser, it is important to remember that a safety goggle with an OD of 6 for one wavelength does not necessarily have an OD of 6 for other wavelengths. The following example illustrates this point.

Example 3

A fiber laser with a power of 500 W and a wavelength of 1550 nm is accidentally pointed into a technician's fully dilated eye pupil (7 mm diameter). The technician's eye is exposed for slightly over 12 s. Calculate the minimum optical density, OD, that a laser safety goggle must have to protect the technician's eye from damage.

Solution

Use the ANSI Z-136.1 to determine the maximum permissible exposure (MPE). We find from this standard that the MPE for radiation of wavelength 1550 nm and an exposure time of 12 s is .1 W/cm².

Calculate the area of the pupil and the irradiance incident on the safety goggles. Since we know the pupil's diameter, we can calculate its area:

$$A = \text{area of pupil} = \frac{\pi d^2}{4} = \frac{(3.14)(.07 \text{ cm})^2}{4} = 0.38 \text{ cm}^2$$

Use the equation below to calculate the irradiance incident on the safety goggles, E_0 :

$$E_0 = P/A = 500\text{W}/0.38\text{cm}^2 = 1315.8 \text{ W/cm}^2$$

Use the following equation to find the minimum required OD:

$$OD = \log_{10} \left[\frac{E_0}{MPE} \right]$$

$$OD = \log_{10} \left(\frac{1315.8 \text{ W / cm}^2}{.1 \text{ W/cm}^2} \right)$$

$$OD = \log_{10}[13,158]$$

$$OD = 4.1$$

The necessary optical density for the laser safety goggles is 4.1 or larger. As this example illustrates, you must check the labels on safety goggles very carefully to be certain that they provide sufficient protection at the laser's operating wavelength.

You should take one further safety precaution when using a fiber laser. Many fiber lasers operate with a transmitting fiber connected to the laser at one end and the work piece or meter at the other. While the connectors may be light-tight, it is possible that a break may occur in the transmitting fiber, which could cause a radiation leak that could be dangerous even though the beam would diverge at the break. If a break occurs in the transmitting fiber, it should be replaced immediately to avoid harm to those operating the laser. All Class 3B and Class 4 lasers require a DANGER sign and an SOP (standard operating procedure). Always consult with your laser safety officer for advice.

TROUBLESHOOTING

Marinating and Troubleshooting Fiber Lasers

Fiber lasers are packaged by the manufacturer in a manner that allows very little opportunity for the photonics systems technician to troubleshoot and repair malfunctions. Since most fiber-laser systems are "warranty sealed," they should not be opened before the warranty expires.

Maintenance of fiber lasers primarily involves keeping the inside of the system clean and dust free, cleaning, and realigning the external optics, and monitoring system diagnostics to learn of any problems.

Most fiber laser systems are computer controlled and come with software that tracks the output parameters, warns of problems, and provides some diagnostics. Typical malfunctions in a fiber laser system are 1) loss of beam power and 2) degradation of the spatial beam characteristics.

Loss of Beam Power

Diode-pumped fiber lasers (DPFL) may experience a failure (or degradation) of one of the diode pump modules, which will result in a decrease of output laser power. For fiber lasers with multiple diode modules, the power may decrease in increments. When one or more of the diode arrays in a diode module fails, the output power of the fiber laser will decrease. The computer diagnostics system should analyze and describe this type of failure. To correct the problem, replace the malfunctioning diode module. For some systems, the manufacturer can supply the module and the photonics systems technician (PST) can perform the replacement. Other systems require that the manufacturer replace the module.

Loss of beam power may also be due to inadequate cooling. Diode pump modules have thermoelectric coolers (TECs) that can malfunction, thus causing the diode modules to perform improperly. Correcting this problem involves replacing the diode module.

The fiber laser system also has a cooling system, which consists of internal and external fans. The PST can check to ensure that these fans are functioning properly and take any necessary corrective action.

Degradation of the Output Beam's Spatial Characteristics

All fiber lasers use an externally coupled optical fiber to translate the beam to the application. It is vital to keep the optical fiber and the relevant optical system clean and maintained.

If the coupling becomes misaligned, the output beam power will be lowered and the beam quality will degrade. Some fiber lasers may be susceptible to feedback from external optics in the coupler or other optical components. If a portion of the output beam is reflected back into the fiber laser cavity, the beam may become degraded or optical components may be damaged. Fiber laser manufacturers are aware of this potential problem, and many have made corrections to prevent it.

LABORATORY

Laboratory 2-5

Measurement of CW and Pulsed Output from a Fiber Laser

Purpose

After completing this laboratory, you should be able to:

- Measure the output characteristics of CW and pulsed fiber laser systems. Measurements will include:
 - Power (W)
 - Wavelength (λ)
 - Mode (TEM)
 - Beam diameter at 2.54 cm from beam exit
 - Divergence (Θ , mrad)
 - Power stability using statistical analysis
 - E (mJ)
 - P_{avg} (W)
 - P_{peak} (W)
 - Pulse Duration/Width (s)
 - Pulse Repetition Rate (PRR, Hz)
 - Pulse Repetition Time (s)
- Operate all equipment using the safety precautions and procedures specified in their user manuals.
- Devise experimental procedures to accomplish the objectives of this laboratory.
- Develop a lab report that contains the following information:
 - List of all equipment used.
 - Detail of the procedures followed.
 - All equations with explanation and calculations required.
 - Schematic of the completed lab setup, including dimensions and labels.
 - Data of all pertinent laser parameters measured.
 - Graphs/photos/drawings, etc., of data/procedure results.
 - Comparison/analysis of measured values to manufacturer's specifications

Equipment

1. Fiber laser with CW and pulsed capabilities
2. Laser safety goggles for appropriate wavelength and OD
3. Beam analyzer/profiler
4. Optical power measuring system (OPMS)
 - a) Relevant detector
 - b) Relevant meter
5. Various support components, tools, etc. (See equipment list for *Fundamentals of Light and Lasers* course.)
6. Beam dump/block
7. IR viewing card/scope
8. Laser mode burn paper (Zap It)
9. Microscope slide or wedge beamsplitter or attenuator
10. Neutral density filter
11. Fast photodiode
12. Digital oscilloscope

Pre-Lab Familiarization

This laboratory will require students to set up, operate, and characterize a fiber laser. Primary directions for performing these tasks will come from the user manual that accompanies the laser. Before beginning this laboratory, students should familiarize themselves with their laser's user manual.

Procedures

Turning on the laser system

1. Before turning the fiber laser on, carefully mount, align, and position the output fiber so that it is parallel to the optical table top and securely mounted.
2. The optical axis of the laser beam should be parallel to the optical table top/breadboard at all times. This includes those times when the beam is reflected or otherwise changed.
3. Set the height of beam's optical axis so that it interacts with all mounted components and equipment that the laboratory requires.
4. Place a laser beam dump (laser beam/heat containment) at 0.5 m (or distance of choice) from laser beam exit along its optical axis.
5. Remove any reflective components between the fiber end/beam exit point and beam dump.
6. Everyone who is near the laser while it is operating MUST WEAR safety goggles.

7. Be sure the laser beam shutter is closed. Then turn on the laser and allow it to warm up, according to the user manual.
8. Set laser power for continuous wave (CW) operation.

NOTE: We highly recommend that you take each measurement three times and use the average of these three measurements as your final measurement. Include all three measurements and the final average in your data table. This practice increases the accuracy of the measurement process.

Continuous Wave Operation

Power (P_{max}) and Wavelength (λ)

1. Position the optical power reading system's (OPRS) power detector in the optical axis of the laser beam between the laser beam exit point and the beam dump. Closer is usually better.
2. Be sure to read the OPRS user manual to know if the power detector is able to handle the irradiance. Levels of irradiance beyond those specified in the user manual will damage the detector.
3. Tilt the meter head slightly with respect to the incident beam. This will prevent back reflections (if any—it depends on the detector type) from returning to the laser.
4. Open the beam shutter and align the center area of the power detector to the laser beam's optical axis.
5. Use the IR card/viewer to position the beam.
6. Read P_{max} and record its value in Data Table 1.

Data Table 1

Continuous Wave	
Wavelength (λ)	
P_{max} (W)	
Mode (TEM/ M^2)	
Divergence (mradians)	
Power stability using statistical analysis	
Beam diameter (d_1 @ 2.54 cm from beam exit)	
Beam diameter (d_2 @ l_2)	

NOTE: You may need to change the data tables to meet the demands of your data.

7. You will find the wavelength for your laser in the user manual.
8. Record the wavelength (λ) in the Data Table 1.
9. Close the laser beam shutter.

Mode, Beam Diameter, and Divergence Measurements:

1. Measure 2.54 cm (1 inch) from the laser beam exit along the beam's optical axis.
2. Mount and place the laser burn paper (Zap It paper) at this position.
3. Open the shutter and operate the laser to create a mode burn pattern on the paper. The goal is to obtain 1 or 2 acceptable mode burn/beam profiles at 2.54 cm (l_1).
 - a) Initially set the laser at its lowest power/repetition rate (power versus time). This may take several attempts.
 - b) Once the mode burns/beam profiles are obtained, close the shutter.
4. Reposition the laser burn paper at any arbitrary distance (l_2) from the 2.54 cm position.
 - a) For the sake of ease, we recommend that this distance (l_2) be evenly divisible by 10—for example, 10 cm, 20 cm, 30 cm, etc.
 - b) Open the shutter and operate the laser to imprint another mode burn/beam pattern on the paper.
 - c) Close the shutter.
5. Measure and record the laser burn-pattern diameters at l_1 and l_2 .
 - a) At both l_1 and l_2 , measure the beam's x- and y-axis diameters.
 - b) The average of the x and y diameters at l_1 and l_2 are the beam diameters d_1 and d_2 , respectively. Record these beam diameters in Table 1.
 - c) Review the burn pattern and identify the mode (TEM) of the laser. Record the mode in Data Table 1.
6. Measure and record the distance (L) between these two locations, l_1 and l_2 .
7. Calculate and record in Data Table 1 the full angle divergence using the following equation:

$$(\theta) = d_2 - d_1 / L$$

Power Stability Measurement

1. Turn on the laser (be sure to use the beam dump) and allow it to warm up so that all temperatures in the system stabilize.

NOTE: The power detector is a thermal detector and so responds slowly to changes in radiation level. Read its user manual to find information related to its responsivity.

2. Align OPRS's detector in the laser beam's optical axis at some arbitrary but close distance.
3. Open the shutter and read and record power data over time.
 - a) Obtain a one-hour minimum of 60 data points. (Industry standard is normally 24 hours.) This may be done manually or with a computer-based system.
 - b) Read and record all data points in Data Table 2.

Data Table 2

Time	Power
1 min	
2 min	
3 min	
.	
.	
.	
60 min	

- c) Using the statistical functions on a calculator, spreadsheet, or statistical program, analyze Data Table 2 and determine the average power and standard deviation. Record these statistical results in Data Table 1.
4. Close the shutter.

Pulsed/Modulated Operation

Average Power

1. Position the optical power reading system's (OPRS's) power detector in the optical axis of the laser beam between the laser beam exit point and the beam dump. Closer is usually better.
2. Set the laser to operate PULSED/MODULATED.
 - a) Open the shutter.
 - b) Select three repetition rates (trials) for the data table depending on the laser and the oscilloscope's capabilities.
 - c) Use the OPRS to measure the average power at each setting. Record these power measurements in Data Table 3.
 - d) Close the shutter.

Data Table 3

Pulsing			
	Trial 1	Trial 2	Trial 3
P_{avg} (W)			
P_{peak} (W)			
PRT (s)			
PRR (s^{-1})			
E/pulse (mJ)			
τ (ns)			

Pulse Duration: (τ , FWHM, $\Delta t_{1/2}$)

1. Position the laser and beam dump as in previous experiments.
2. Insert a microscope slide or wedge beam splitter into the laser beam path at a 45° angle with respect to the optical axis. The transmitted beam should stop at the beam dump. The first surface reflection of the beam from microscope slide or wedge beam splitter will be measured in this experiment.
3. Turn on the oscilloscope and adjust its settings to display the laser pulse.
4. Set the laser for the lowest energy/pulse duration output. Open the shutter.
5. Use the IR viewer or viewing card to locate the first surface reflection from the microscope slide or beam splitter.
6. Align the center of the photodiode to the reflected beam's optical axis. Use attenuation devices to allow the photodiode to accept the beam power. Overloading the detector will result in erroneous readings.
7. Using the oscilloscope, observe the displayed pulse.
8. Check to be sure that the displayed pulse is the actual laser pulse desired. If the photodiode is saturated, the oscilloscope display will show the peak of the pulse simply "chopped off" as a distorted waveform. If this is the case, place a neutral density filter assembly in front of the photodiode so that the laser pulse is not clipped or distorted.
9. Set the laser to the same three pulse repetition rates you used when you were collecting data to determine average power for Data Table 3. Using the oscilloscope, measure and record in Data Table 3 for each of these pulse repetition rates:
 - a) Pulse repetition rate (PRR)
 - b) Pulse repetition time (PRT)
 - c) Full width at half maximum (FWHM or τ or $\Delta t_{1/2}$)
10. Close the shutter and turn off the laser. Secure lasers and laboratory according to departmental procedures.
11. Calculate and record in Data Table 3:
 - a) Energy per pulse (E, mJ): $E = P_{avg}/PRR$
 - b) Peak Power (P_{peak} , W): $P_{peak} = E/\tau$

WORKPLACE SCENARIO

Here is your opportunity to use the concepts you have learned in this module to solve an actual problem that could arise in a photonics company. Your instructor will provide directions for developing a solution.

Fiber vs. CO₂ Lasers in Material Processing

Scenario

Your company is presently using a CO₂ laser to cut aluminum plates. You have been tasked with researching the advantages and disadvantages of switching to a fiber laser for cutting the aluminum plates. You have been asked to recommend a fiber laser to purchase, including the supplier and model. The size of the aluminum plates is 50 cm by 100 cm. The thickness of the plates is 8 mm. Production volume requires a cutting speed of at least 1000 mm/s.

Additional Information

You can find the information you need to solve this problem from at least three sources:

1. OP-TEC Photonics-Enabled Technologies Module: *Laser Material Removal: Drilling, Cutting, and Marking*.
2. An explanation of the laser output characteristics for CO₂ lasers can be found in Module 2-4, *Carbon Dioxide Lasers and Their Applications*.
3. You can conduct an Internet search of “fiber laser tutorials.”
4. You can conduct an Internet search of fiber laser manufacturer sites with application notes.

Problem and Tasking

1. Research and document the advantages and disadvantages of using a fiber laser versus a CO₂ laser.
2. Based on the cutting requirements given, research and recommend fiber lasers for consideration from two different suppliers. Define their:
 - a) Wavelength requirements
 - b) Power requirements
 - c) Cooling requirements
3. Consider other process and equipment changes that may have to be made as a result of switching to a fiber laser cutting process, such as safety glasses, training, assist gases, Class 4 laser room changes, etc.

PROBLEM EXERCISES AND QUESTIONS

1. Draw and label a diagram of a simple fiber laser and explain the components in the diagram.
2. What three types of mirrors are used to form the fiber laser cavity? Briefly describe them.
3. Describe three methods of pulsing fiber lasers and the range of pulse durations for which each method is typically used.
4. Name at least three of the rare earth elements used for doping fibers in fiber lasers.
5. Discuss how fiber lasers are pumped.
6. Discuss the characteristics of fiber lasers, as described in the text.
7. Describe what is meant by double-clad fibers and why they are used.
8. Discuss master oscillator power amplifier (MOPA) fiber lasers. Use a diagram.
9. A single-mode erbium-doped fiber laser operating at a wavelength of 1550 nm has a core diameter of 150 μm . What is the beam divergence angle?
10. List at least six of the advantages of fiber lasers presented in the text.
11. Discuss briefly at least three of the materials-processing applications described in the text.
12. Discuss the output-power capabilities of fiber lasers.
13. State the efficiency of fiber lasers and compare it to Nd:YAG and carbon dioxide lasers.
14. A fiber laser operating in a single mode at a wavelength of 1100 nm has a core diameter of 55 μm . What is the beam-divergence angle?
15. Name the applications (other than materials processing) mentioned in the text. Briefly describe at least two of them
16. Why do fiber lasers have low maintenance requirements?

REFERENCES

- Amaya, Phill. 2010. Fibers for Fiber Lasers: Structured Fiber Advances Short-Pulse Laser Performance. *Laser Focus World*. July 1.
<http://www.laserfocusworld.com/articles/2010/07/fibers-for-fiber-lasers.html> (accessed January 16, 2014).
- Carter, Adrian. 2009. Increased Output and Efficiency of Fiber Lasers. *Photonics Spectra*. August 1. <http://www.photonics.com/Article.aspx?AID=34668> (accessed January 16, 2014).
- Carter, Adrian, Bryce Samson, and Kanishka Tankala. 2009. Fiber Lasers: Thulium-Doped Fiber Forms Kilowatt-Class Laser. *Laser Focus World*. April 1.
<http://www.laserfocusworld.com/articles/print/volume-45/issue-4/features/fiber-lasers-thulium-doped-fiber-forms-kilowatt-class-laser.html> (accessed January 16, 2014).
- Ding, Jim, Bryce Samson, and Payman Ahmadi. 2011. Fiber Amplifiers: High-Power Fiber Amplifiers Enable Leading-Edge Scientific Applications. *Laser Focus World*. February 1.
<http://www.laserfocusworld.com/articles/print/volume-47/issue-2/features/fiber-amplifiers-high-power-fiber-amplifiers-enable-leading-edge-scientific-applications.html> (accessed January 16, 2014).
- Kimura, Masato, ed. 2009. *Fiber Lasers: Research, Technology and Applications* Hauppauge, NY: Nova Science Publishers.
- Overton, Gail. 2008. Optoelectronic Applications: Microprocessing - Ultrafast Fiber Lasers Forge New Microprocessing Frontiers. *Laser Focus World*. July 1.
<http://www.laserfocusworld.com/articles/print/volume-44/issue-7/features/optoelectronic-applications-microprocessing-ultrafast-fiber-lasers-forge-new-microprocessing-frontiers.html> (accessed January 16, 2014).
- Samson, Bryce, Jens Biesenbach, and Georg Treusch. 2008. Fiber-Laser Pumping: Diode Technology Advances Fiber-Laser Pumping. *Laser Focus World*. September 22.
<http://www.laserfocusworld.com/articles/2008/09/fiber-laser-pumping-diode-technology-advances-fiber-laser-pumping.html> (accessed January 16, 2014).
- Shah, Lawrence, Kiyomi Monro, and Gyu C. Cho. 2008. Ultrafast Fiber Lasers: Femtosecond Fiber Laser Enables Reliable Wafer-Level Processing. *Laser Focus World*. December 1.
<http://www.laserfocusworld.com/articles/2008/12/ultrafast-fiber-lasers-femtosecond-fiber-laser-enables-reliable-wafer-level-processing.html> (accessed January 16, 2014).
- Shenkenberg, David L. 2009. Fiber Lasers Cut Into New Industries. *Photonics Spectra*. May 1.
<http://photonics.com/Article.aspx?AID=37274> (accessed January 16, 2014).

INDEX OF TERMS

A

Applications, 16, 20-29
 Materials processing, 20-21
 Telecommunications, 24
 Spectroscopy, 25
 Medicine, 26-27
 Military, 28
Advantages, 17-20

C

Chirally clad cores, 14
Core, 4, 8
Critical angle, 7

D

Dark marking, 26
Distributed Bragg reflectors (DBRs), 5
Double-clad fiber, 5, 8, 13

F

Fiber couplers, 6
Fiber-disk laser, 15

G

Geometry (see structure), 2
Graphene, 11

I

Inner cladding, 4, 8
Irradiance, 18, 21

L

Large mode area (LMA) fibers, 14
Lasing, 8

M

Master oscillator power fiber amplifier (MOPFA), 9
Material selection, 3, 4, 16
Mirrors, 5
Multiple pump sources, 6

O

Outer cladding, 4, 8
Output characteristics, 12-13
 Tunability, 12
 Frequency doubling, 12
 Beam divergence, 13

P

Pedestal (see inner cladding), 4
Power, 16, 17
Pulsing, 9-11
 Q-switching, 9-10
 Mode locking, 10-11
Pumping, 4, 6
Raman fiber lasers, 15

S

Safety considerations, 30
Semiconductor saturable absorber mirrors (SESAM), 5
Structure, 2, 3, 4, 13, 14, 15

T

Total internal reflection (TIR), 8
Troubleshooting, 32

Diode Lasers and Their Applications

Module 2-6

of

Course 2, *Laser Systems and Applications*
2nd Edition

OPTICS AND PHOTONICS SERIES



© 2016 University of Central Florida

This material was developed by the National Center for Optics and Photonics Education, OP-TEC, and is based upon work supported by the National Science Foundation under Grant No. 1144377 and completed under Grant No. 1303732. Any opinions, findings, and conclusions or recommendations expressed in this material are those of the author(s) and do not necessarily reflect the views of the National Science Foundation.

For more information about the text or OP-TEC, contact:

Dan Hull

PI, Executive Director, OP-TEC

316 Kelly Drive

Waco, TX 76710

(254) 751-9000

hull@op-tec.org

Published and distributed by

OP-TEC

316 Kelly Drive

Waco, TX 76710

254-751-9000

<http://www.op-tec.org/>

ISBN 978-0-9983480-5-6

CONTENTS OF MODULE 2-6

Introduction	1
Prerequisites	1
Objectives.....	2
Basic Concepts	3
Energy Transfer in Semiconductor Lasers	3
Current Flow Through a Semiconductor.....	3
Emission of Light by Semiconductor Diodes	4
Basic Semiconductor Laser Design.....	6
Crystal Preparation and Internal Structure	6
Mounting and Cooling	7
Output Characteristics of Semiconductor Lasers	9
Temperature Dependence of Semiconductor Laser Output	10
Spectral Characteristics	11
Spatial Characteristics	13
Materials Used in Semiconductor Lasers.....	14
Developments in Semiconductor Laser Types.....	16
Advances in Laser Junction Structure.....	16
High-Power Devices	17
Distributed-Feedback Structures	18
Vertical Cavity Surface Emitting Lasers.....	19
Short-Wavelength Semiconductor Lasers.....	20
Damage Mechanisms for Semiconductor Lasers and Prevention of Damage	21
Damage Mechanisms	21
Methods for Limiting Damage.....	22
Applications of Semiconductor Lasers	22
Optical Telecommunications.....	23
Optical Data Storage and Retrieval.....	25
Diode-Pumped Solid State (DPSS) Lasers.....	28
Fiber Lasers	30
Replacement for Helium-Neon Lasers.....	31
Materials Processing	31
Medical and Dental Applications.....	32
Summary	32
Safety Considerations.....	33
Troubleshooting	35
Laboratory	37
Workplace Scenario	44
Problems Exercises and Questions.....	46
References	47
Index of Terms	48

Module 2-6

Diode Laser Systems

INTRODUCTION

Diode lasers, as their name implies, are diodes that emit coherent light by stimulated emission. They consist of a p-n junction inside a slab of semiconductor that is typically less than a millimeter in every dimension. Excitation is provided by current flow through the device, and the cleaved ends of the diode provide the feedback mirrors. They are often called simply diode lasers or laser diodes or semiconductor laser diodes. This module will use the terms *diode laser*, *semiconductor laser* and *semiconductor diode laser* interchangeably.

The output characteristics of diode lasers differ from those of other laser types in two important ways. Because of their small size, they have beam divergence angles of as much as 20° . The nature of the active medium also allows lasing over a broad wavelength range and produces an output that is less monochromatic than that of other laser types.

Diode lasers have many important applications, including communications, compact disc and DVD players, and, more recently, pumping of solid state lasers and even materials processing. Semiconductor lasers have high efficiency (up to around 50%) and a small size. Because of these facts, and because of their applications in communications and information storage, far more semiconductor lasers are manufactured and sold every year than all other types of lasers combined. It is estimated that many hundreds of millions of semiconductor lasers are manufactured each year.

This module will describe the basic principles of operation of semiconductor lasers, their properties, and the different types of structure that they can have. Finally, the module will emphasize more recent developments in semiconductor lasers and their applications. In particular, the module will describe vertical cavity surface emitting lasers (VCSELs) and their characteristics.

In the laboratory, the student will operate a semiconductor laser and measure its output characteristics.

PREREQUISITES

OP-TEC's *Fundamentals of Light and Lasers Course*

OP-TEC's *Laser Systems and Applications Course, Module 1: Laser Q-Switching, Mode Locking, and Frequency Doubling; Module 2: Laser Output Characteristics and Module 3: Laser Types and Their Applications*

Understanding of high school level trigonometry and algebra concepts, including exponentials and logarithms

OBJECTIVES

Upon completion of this module, the student should be able to:

- Draw and label the energy level of a semiconductor diode laser.
- Describe the mechanisms of current flow in the p-region, n-region and junction region of a diode.
- Describe the process by which laser diodes produce light.
- Draw and label a diagram of a simple GaAs laser.
- Explain two primary loss mechanisms in semiconductor lasers.
- Explain how the wavelength and threshold current in diode lasers vary with operating temperature.
- Describe the spectral output of a semiconductor laser.
- Describe the beam divergence of a laser diode, and explain what produces it.
- Define what is meant by ternary and quaternary semiconductor lasers, and give one example of each type.
- Describe vertical cavity surface-emitting lasers.
- Discuss short-wavelength semiconductor lasers.
- Discuss the mounting and cooling of semiconducting lasers.
- Name applications of semiconductor lasers, including telecommunications and the pumping of other types of lasers.
- List five advantages of semiconductor lasers as compared with other lasers.
- Describe five processes that produce damage in laser diodes and ways to counteract them.

BASIC CONCEPTS

Energy Transfer in Semiconductor Lasers

Semiconductors are materials that have an intermediate level of electrical conductivity between the high conductivity of metals and the low conductivity of insulators. In a good electrical conductor, such as a metal, the outer electrons of the atoms are able to move freely through the metal so that conduction of electricity is easy. In an insulating material (for example, common table salt), the electrons are tightly bound to their parent atoms and are not free to move through the material when a voltage is applied to it. Therefore, the electrical conductivity is low. In a semiconductor, the outer electrons are usually bound to their parent atoms, but a small fraction of them can migrate through the material. The mobility of that small fraction of electrons gives the material some degree of electrical conductivity.

The most commonly known semiconductors are silicon and germanium, which have been used for electronic applications such as rectifiers and transistors. However, the first semiconductor material that was used in lasers was gallium arsenide, which is a compound of chemical element 31, gallium, and chemical element 33, arsenic. Its chemical designation is GaAs.

For a number of years, gallium arsenide lasers were the most common type of semiconductor lasers. They were first demonstrated in 1962. Many of the early studies of the properties of semiconductor lasers were performed with them. But over time, a variety of semiconductors of more complex types, with three or four chemical elements in their composition, have been developed. Examples are gallium aluminum arsenide, indium gallium arsenide phosphide, and indium gallium nitride. For the most part, gallium arsenide lasers are now obsolete, and semiconductor lasers are fabricated from more complicated chemical structures that include three or four chemical elements.

This module will describe the basic physical properties and operation of semiconductor lasers. To simplify these descriptions, we often use the early gallium arsenide lasers as examples. Later on in the module, we describe the structures, properties and applications of more modern semiconductor lasers.

Current Flow Through a Semiconductor

Semiconductors such as silicon have four electrons in their outer atomic shell. In the semiconductor crystal, each atom forms electron pair bonds with four other atoms. By sharing four outer electrons with four neighboring atoms, each participating atom “fills” its outer electron shell; a filled shell has eight electrons. This leaves no free electrons for conduction in a pure semiconductor. Some conduction still occurs, though, because the electrons in the outer shell are not tightly bound to their atoms and may be freed by thermal energy. Thus, pure semiconductors have a high electrical resistance at low temperatures and lower resistance at higher temperatures.

The electrical conductivity of a semiconductor can be increased by adding doping elements, or small percentages of impurity elements, to the semiconductor. The presence of the small traces of impurity elements can yield extra charge carriers that are free to move through the material.

In the compound gallium arsenide, each gallium atom has three electrons in its outermost shell of electrons, and each arsenic atom has five. This gives an average of four electrons per atom in the compound that, just like the electron sharing in silicon, “fills” the outer electron shell of the sharing atoms. When a trace of an impurity element with two outer electrons, such as zinc, is added to the crystal, the result is the shortage of one electron from a bonding pair. This shortage sets up an imbalance in which there is a place in the crystal for an electron but there is no electron available. This “place” is commonly called a “hole.” The existence of a hole forms the so-called p-type semiconductor, electricity is conducted by the hole’s movement from one atom to another. Here, p stands for “positive,” because the hole, or lack of an electron, looks like an extra positive charge.

When a trace of an impurity element with six outer electrons, such as selenium, is added to a crystal of GaAs, it provides one additional electron. Since the atoms share electrons, this additional electron is not needed to “fill” the atoms’ outer electron shell, so it is free to move through the crystal. Thus, it provides a mechanism for electrical conductivity. When this type of impurity is added to GaAs, it becomes an n-type semiconductor, where n stands for “negative,” because the carrier of electricity is the negatively charged electron.

When p-type and n-type regions are grown side by side in a semiconductor material, the result is a p-n junction. On one side of the junction (the n-region), conduction is by electrons, and on the other side (the p-region), it is by positive holes. Such a device is called a diode, and it allows current flow in only one direction. In reality, the junction is not a line in the diode separating the n-type material from the p-type material. Instead, it is a very small region a couple of hundred nanometers wide and is often referred to as the depletion region. In this region, there is an intrinsic electric field pointing from the n-side of the junction to the p-side. This electric field is a barrier that precludes electrons and holes from diffusing across the region, thus “depleting” the region of charge.

When a forward voltage is applied to the junction—that is, when the positive side of a battery is connected to the p-side and the negative to the n-side—the density of the carriers, both p-type and n-type, increases around the junction. The net effect of this redistribution of charge is to reduce the intrinsic electric field barrier and allow the diffusion of electrons and holes to resume. This diffusion constitutes a current and the diode is said to be forward biased. When a reverse voltage is applied to the junction, the charge carriers in the n-type and p-type materials move away from the junction increasing the intrinsic electric field barrier and eliminating virtually all diffusion in the junction region. Thus, when reversed biased a diode allows little, if any, current to move through it.

Emission of Light by Semiconductor Diodes

Figure 6-1 shows the energy-level diagram of a semiconductor diode. In semiconductor materials, electrons may have energies within certain bands. In the figure, the lower region is called the valence band and represents the energy states of bound electrons. The upper region is the conduction band and represents the energy states of free or conduction electrons. Electrons may have energies in either of these bands, but not in the gap between the bands.

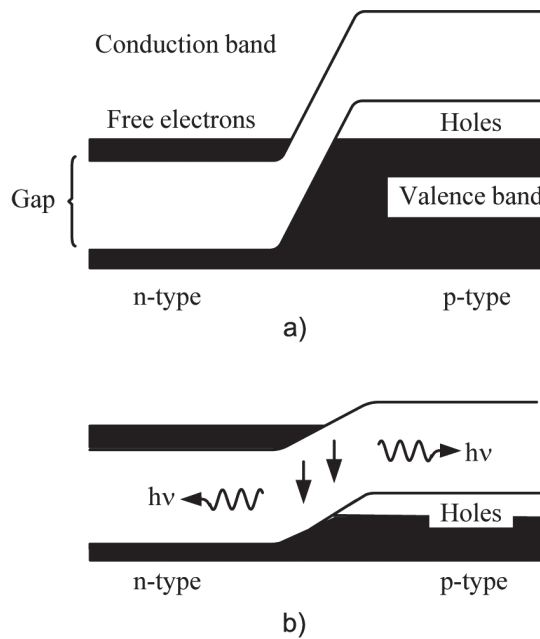

Figure 6-1 Energy-level diagram of a semiconductor diode
a) No voltage; b) forward applied voltage

Figure 6-1a shows the relative populations of the energy bands on both sides of a p-n junction with no external voltage applied to the diode. The conduction band of the n-type material contains electrons that act as current carriers, whereas the valence band in the p-type material has holes that act as current carriers. When a forward voltage is applied to a diode, the energy levels across the junction region of the diode shift, as shown in Figure 6-1b. This shift allows electrons in the n-type material and holes in the p-type material to diffuse more readily into the junction region to establish a current through the diode. While diffusing through the junction, some electrons will combine with holes. Since the electrons in the conduction band have energies greater than those in the valence band, the electrons that combine with holes lose an amount of energy equal to the semiconductor's band gap energy. These electrons' energy loss appears as photons of light with a wavelength λ given by Equation 6-1.

$$\Delta E = hc/\lambda \quad (6-1)$$

Where ΔE is the band gap energy, h is Planck's constant, c is the speed of light, and λ is the wavelength of the emitted photon.

As the forward voltage is increased across the diode, the current in the diode increases, and more and more electrons and holes enter the junction region and combine with one another. Each time a hole and an electron combine, the electron drops from the conduction band to the valence band and generates a photon. At this point, the diode is operating as a light emitting diode (LED). As the forward voltage is further increased, the number of photons generated in the junction region becomes large enough to initiate the process of stimulated emission. This means that photons produced from the combining of electrons and holes stimulate other conduction band electrons in the junction region to drop to the valence band and release photons

that are identical to the stimulating photon. The diode current at which stimulated emission begins is called the *threshold current*. At the threshold current, the diode begins operating as a laser. The forward voltage is the pump, the junction region is the active medium, and the two ends of the junction region become the high reflectivity mirror and the output coupler. Later in the module, we describe how the mirror and coupler are formed.

Basic Semiconductor Laser Design

Now that you understand the basic concepts that describe how diode lasers work, we turn to how these concepts are used in designing these lasers. Though diode lasers use a wide variety of semiconductor materials, we focus our design discussion on the GaAs laser. As mentioned above, this was the first material used in a diode laser, and it also has one of the least complex structures. We start with this simple material, present some basic diode laser designs, and then introduce more complex materials later in the module.

Crystal Preparation and Internal Structure

GaAs lasers may be prepared from ingots of gallium arsenide crystals that are mounted on glass plates with wax and cut into slices about 0.5 mm thick. After the slice is formed, the junction is prepared by diffusing impurities in from the surface. Thus, if the original ingot is n-type, a p-type impurity (for example, zinc) is diffused into it. The diffusion is carried out by sealing the gallium arsenide slice into an evacuated ampoule (sealed vial), together with a weighed amount of zinc. The ampoule is then heated in a furnace. Zinc vapor diffuses a short distance (a few micrometers) into the surface of the slice and forms a p-n junction. The slice then is cut or cleaved into blocks of suitable size to form the individual lasers. The blocks are small and fragile and are mounted by sandwiching them between two gold-clad metal disks. The block's dimensions are typically about one or two millimeters. The light-emitting region—that is, the junction—from which the radiation originates, is a thin layer only a few micrometers thick. The completed laser diodes are then attached to a copper heat sink on one side and a small electrical contact on the other.

Figure 6-2 is a diagram of the simplest (and earliest) type of gallium arsenide laser. The laser is a brick-shaped piece of GaAs prepared according to the process described above. GaAs cleaves easily along certain crystal planes, leaving flat parallel surfaces.

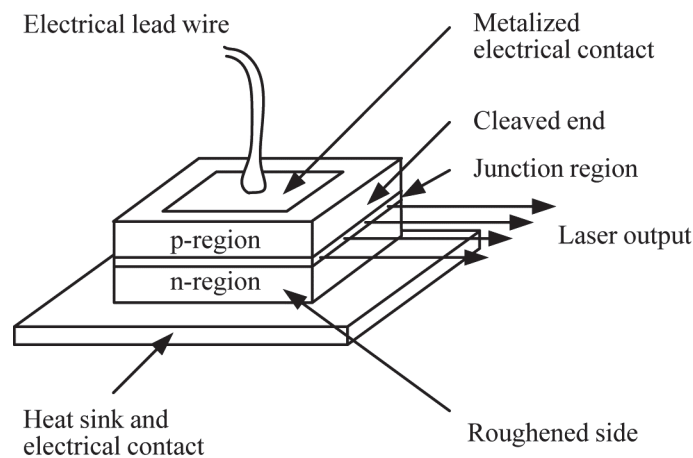

Figure 6-2 Gallium arsenide laser diode

Usually, the mirrors for feedback and output coupling are formed from the cleaved ends of the laser diode, with no further coating. The reflectivity at the interface between gallium arsenide and air is approximately 36%. If output is desired from only one end of the device, or if mirrors of higher reflectivity are desired to reduce the threshold for laser operation, the reflectivity may be increased by coating the surfaces with metal films. Optical standing waves may exist between any two of the parallel surfaces of the diode. Two sides are purposely roughened to reduce reflection and prevent lasing “across” the diode cavity.

The output power available from this laser is limited by the loop gain available within the laser cavity. The amplifier gain of the active medium is dependent on the current density through the junction. Higher currents produce greater power, but higher currents also increase heating effects that can damage the device.

Losses in the laser cavity have two primary causes. The first of these is diffraction loss. The active region has a width of only about one micrometer. Thus, light quickly diverges out of the active region. This loss may be reduced by making the junction wider and by better confining the light to the active region. The second loss factor is absorption of the laser light by free carriers in the junction region. This loss may be reduced by lowering the device’s temperature, which reduces the number of free carriers.

The band gap (ΔE in Equation 6-1) of GaAs is 1.43 eV at a temperature of 300° K. This is the energy required to raise an electron from the valence band to the conduction band. Using Equation 6-1, we find that the wavelength of the GaAs laser is around 870 nm.

It is possible to develop laser diodes composed of many different chemical elements, each of which has its own unique band gap. As a result, diodes composed of different combinations of p and n-type materials can produce laser light with many different wavelengths.

Mounting and Cooling

When you buy a semiconductor laser, the manufacturer does not give you a bare semiconductor chip. Instead, these lasers are sold in housings that have electrical leads attached and are mounted to allow for reasonably easy handling. The housing may resemble a transistor package. Also, the housing may contain cooling structures or have provisions for attachment to a heat sink. Figure 6-3 shows a representative view of such a structure. It is also possible to have a fiber pigtail as part of the package, which allows the laser beam to be easily coupled into an optical fiber.

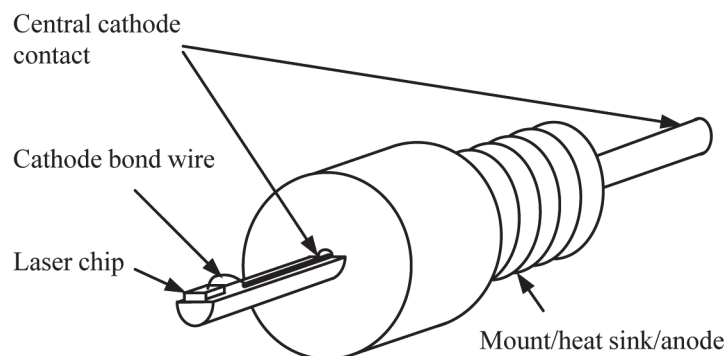

Figure 6-3 Example of a mounting for a semiconductor laser

We describe the harmful effects of excessive temperature in more detail later. Good heat sinking is essential to remove the heat generated by the electrical current and to cool the laser. The heat sink may simply be a flat piece of metal, such as copper. A copper sheet with dimensions around $0.2 \times 2 \times 3$ cm may dissipate about 200 mW of electrical power. To minimize thermal resistance, the laser must be mounted in very close contact to the heat sink. The manufacturers of semiconductor lasers have developed structures that keep the thermal resistance small.

It's also necessary to control the temperature of the laser in order to stabilize the wavelength. The wavelength increases with increasing temperature, sometimes in discontinuous hops. If a specific operating wavelength is needed, the laser temperature must be controlled.

For many applications that require only low power, it's enough to simply mount the laser on a copper plate to spread the heat. For applications requiring higher power, or those requiring good control of the laser wavelength, active cooling is necessary. This may be accomplished with thermoelectric coolers or with water cooling. Thermoelectric coolers, also called Peltier coolers, rely on the fact that if an electric current passes through a thermocouple made of two different metals joined at two points, heat is absorbed at one junction, called the cold junction, and heat is dissipated at the other junction, called the hot junction. There are also versions of thermoelectric coolers that use the transport of holes and electrons in semiconductor materials to dissipate heat. Many semiconductor laser manufacturers offer thermoelectric coolers for their lasers. Figure 6-4a shows an example.

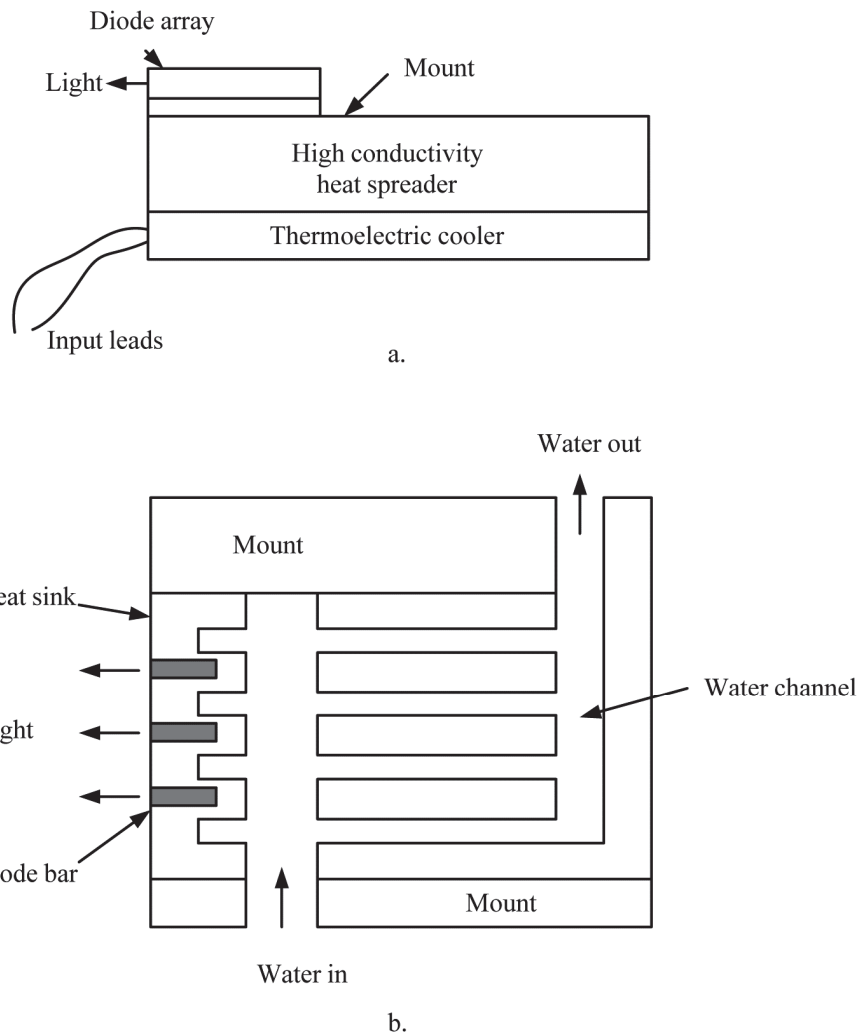

Figure 6-4 Methods for active cooling of semiconductor lasers
a) Side view of a thermoelectric cooler; b) Top view for cooling a diode laser bar

Active water cooling is also often used, especially with semiconductor laser arrays (bars) and stacks (to be discussed later). Figure 6-4b shows how water channels may be incorporated in a metal plate on which an array is mounted. The manufacturers of semiconductor lasers have developed sophisticated ways to create numerous small channels through which water can circulate and cool the lasers.

Structures such as the one shown in Figure 6-4b can serve either as a mount for a single laser array or as the heat sinks between arrays in a stack of arrays.

Output Characteristics of Semiconductor Lasers

The properties of semiconductor lasers are different from those of most other types of lasers. Semiconductor lasers possess few of the properties that are usually associated with lasers. The small dimension of the junction in which the light is produced leads to a beam width of several degrees. This is much greater than the narrow beams of typical gas lasers or solid state lasers.

The spectral width of the radiation from the semiconductor laser is typically around two or three nanometers—much larger than the spectral width of most other lasers. Therefore, a gallium arsenide laser can be regarded as a “small, bright area” source of radiation. Although semiconductor lasers do not possess the properties of directionality and monochromaticity to the same degree as other lasers, they do have many important properties that make them attractive. They can be modulated easily at high frequencies by modulating the current through the junction. They are efficient, small, and rugged, and are much less expensive than other types of lasers.

Temperature Dependence of Semiconductor Laser Output

The output of semiconductor lasers is very strongly dependent on the temperature of the laser diode. As temperature increases, the threshold current for laser operation rises rapidly. Figure 6-5 shows how the output characteristics of a semiconductor laser may change as temperature increases. Graphing the output versus drive current shows the existence of a threshold below which there is essentially no output (or perhaps just a small amount of spontaneous emission) and above which the output increases rapidly. Also, for a given drive current, the output is lower at higher temperatures. Thus, it is extremely important that the temperature be controlled.

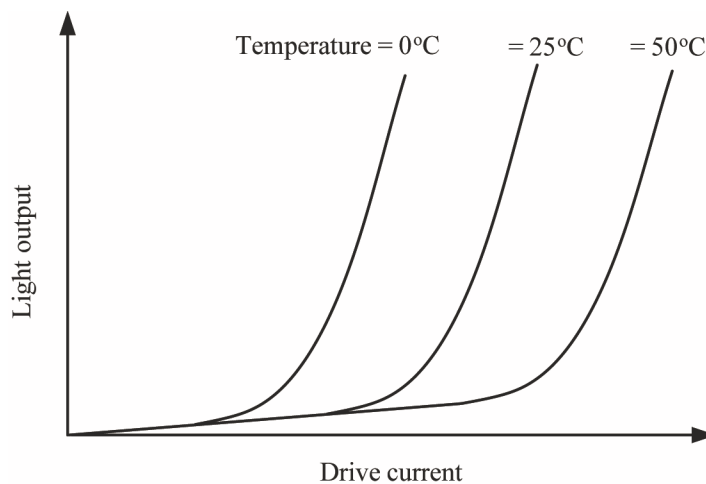

Figure 6-5 *Output of a semiconductor laser as a function of drive current for different operating temperatures*

Early GaAs lasers were cryogenic devices and operated only at 77°K. Now, semiconductor lasers may be operated at room temperature or even somewhat above room temperature. Still, increased temperature decreases output, so the temperature must be limited. Manufacturers frequently state a maximum temperature at which their devices may be operated. For semiconductor lasers operating at high power, cooling is necessary. Much work has been done to develop effective structures for removing heat from the lasers.

Temperature control is also necessary to control the spectrum of the laser output. Figure 6-6 shows how the wavelength of emission of a semiconductor laser may vary with temperature. The figure shows the wavelength of a commercial device operating at a wavelength near 810 nm. There is a gradual shift toward longer wavelength, accompanied by discontinuous

jumps. For any application in which the exact wavelength is important, the laser must be in a temperature-stabilized environment and the temperature must be held constant.

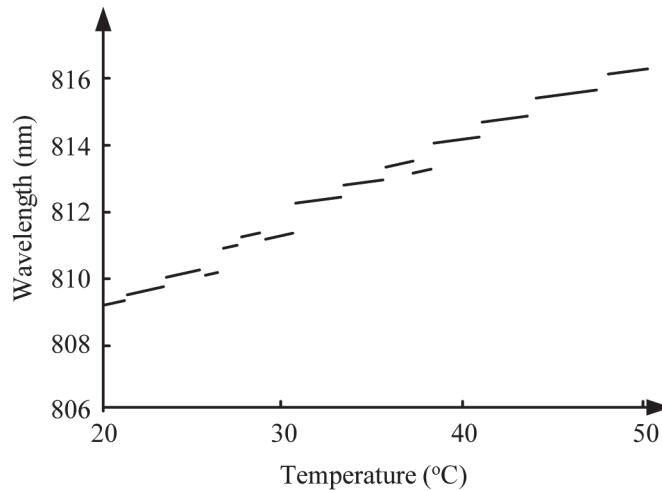

Figure 6-6 *Variation of the wavelength of a commercial semiconductor laser with temperature*

Semiconductor lasers may be operated either CW or pulsed. For CW operation, the limiting factor is the heat that is produced. The maximum output from a particular laser is often limited by the heat generated and the ability to remove heat. CW lasers are available at wavelengths ranging from 375 nm to 1550 nm. Some devices operating in the mid-infrared are also available. CW semiconductor lasers have been operated at powers of up to hundreds of watts, but devices operating in the milliwatt region are far more common.

Semiconductor lasers are usually pulsed by pulsing the power supply. Pulses as short as a few nanoseconds or up to hundreds of microseconds may be produced. Frequently, pulsed semiconductor lasers are operated as repetitively pulsed devices. They can have pulse repetition rates of up to tens of kilohertz. But the maximum pulse rates and the longest pulse durations do not go together. The spectral range of output wavelengths is the same as for CW lasers.

Semiconductor lasers are often operated in what is called a quasi-CW fashion. They are pulsed at a high pulse repetition rate by a pulsed pump with a duration equal to the lifetime of the population inversion. The succession of pulses from the laser appears to be continuous. Heating is reduced because the laser has repeated periods of time when it is not lasing.

Spectral Characteristics

Operation of a semiconductor laser is characterized by a threshold current. Figure 6-7 shows the peak pulsed power of a typical laser as a function of the peak current input. The threshold current for this diode is about 10 A. When the current through the device is relatively low, the laser produces a broad spectrum of spontaneous emission (operating as an LED) with a bandwidth of around 100 nm. When the current through the junction is increased, stimulated emission will begin when the optical gain exceeds the losses. The threshold current density depends on the temperature, absorption losses in the material, the reflectivity of the diode surface, and the doping of the material.

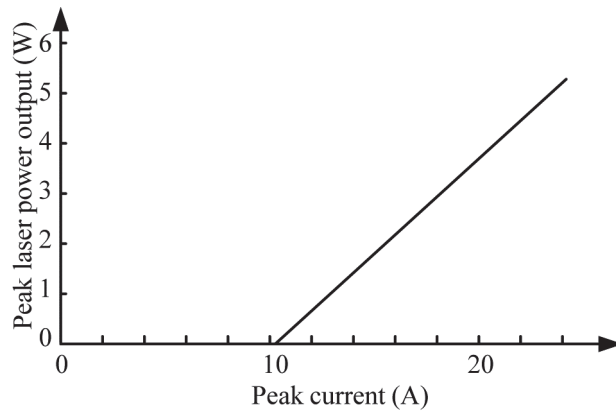

Figure 6-7 Peak power output of laser diode as a function of peak input current

When the threshold current density is exceeded, the emission spectrum narrows dramatically, and the intensity of the emission increases considerably. Figure 6-8 shows the emission spectrum of a laser diode both below and above threshold. At higher currents, the line width of the laser output decreases.

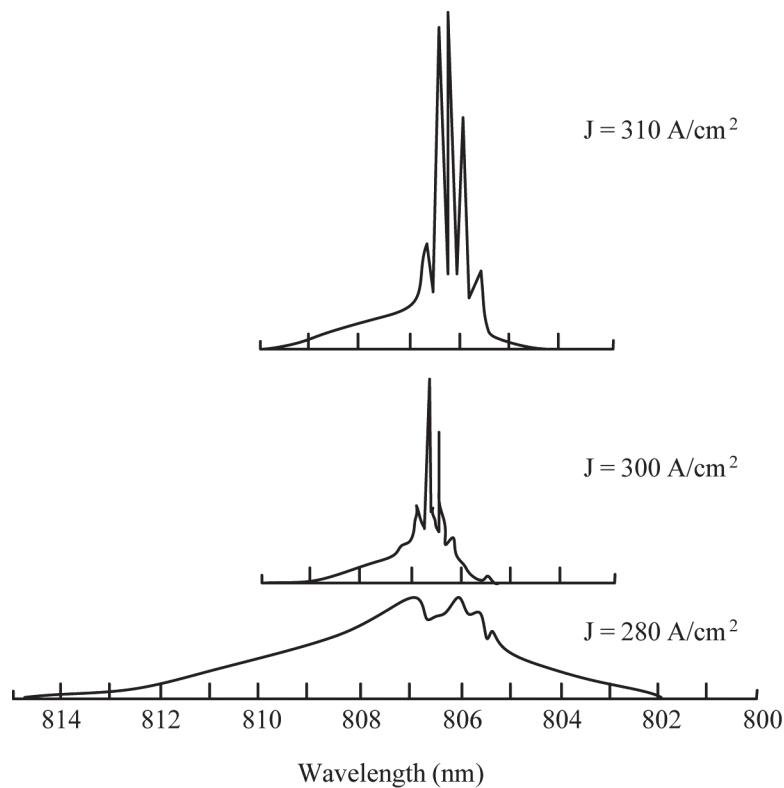

Figure 6-8 Output spectrum of a gallium arsenide laser at various input current densities for continuous operation of a double heterojunction device at cryogenic temperatures

The width of the spectral band represented by spontaneous emission is much greater than that of the stimulated emission. However, stimulated emission produced by the laser is still much broader than that of conventional gas and crystalline lasers. It is on the order of two or three nanometers, as compared with a typical spectral width around 10^{-3} nm for a HeNe laser.

The emission spectrum is relatively complex and typically contains a number of longitudinal modes of the optical cavity. The spacing between longitudinal modes is relatively large because of the short length of the optical cavity. However, the relatively large spectral width of the GaAs laser allows several modes to be present.

Figure 6-9 shows the spectral output of a semiconductor laser operating well above threshold at a wavelength near 1550 nm. In Figure 6-9, the laser output is much greater than threshold, so the spontaneous emission does not show up. The laser modes are well developed and cover a range nearly 20 nm wide. Each individual spike in the spectrum corresponds to one longitudinal mode. The modes are widely spaced because the length of the cavity is small. (The spacing of the longitudinal modes is inversely proportional to the length of the laser cavity.) Figure 6-9 demonstrates how different the spectral output of a semiconductor laser can be from that of other familiar types of lasers.

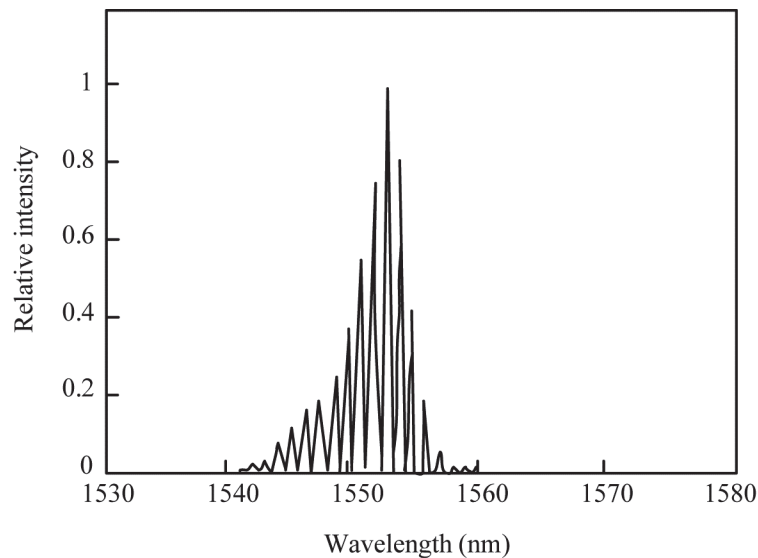

Figure 6-9 *Spectral emission of a commercial semiconductor laser operating at a wavelength near 1550 nm*

It is possible to narrow the spectrum of a semiconductor laser by inserting a wavelength-selecting element. One way to do this is to fabricate a grating on the semiconductor substrate. This is called a distributed Bragg reflector. It provides a wavelength-dependent reflection coefficient that replaces one of the cavity mirrors. This can cause the laser to operate in a single longitudinal mode, that is, in only one of the spikes shown in Figure 6-9. Although the spectrum is narrowed, it is still not as narrow as in typical gas lasers.

Spatial Characteristics

One of the most important characteristics of gas lasers is the very small divergence of the emitted radiation. Semiconductor lasers do not share this characteristic. The main reason is that light is emitted through the aperture defined by the small junction. Diffraction through the narrow dimensions of the junction causes the beam to spread into a broader angle than is observed with other types of lasers. Figure 6-10 illustrates the beam divergence of a typical semiconductor laser. The emission from a semiconductor laser tends to be an elliptical beam with a full angle divergence around 20° in the direction perpendicular to the junction and around

5° in the direction parallel to the junction. These angles may vary considerably between different lasers.

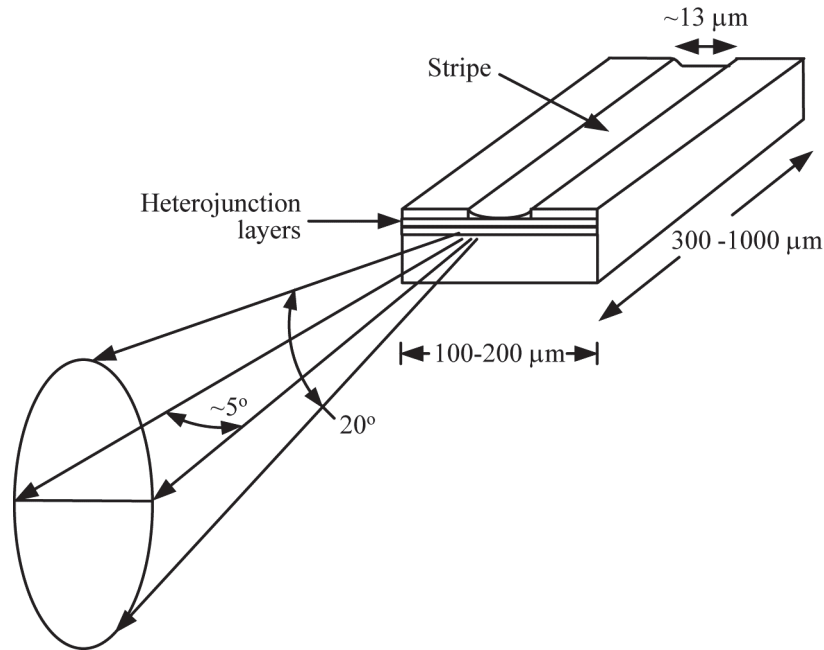

Figure 6-10 *Beam profile from a stripe geometry heterojunction semiconductor laser*

The structure and dimensions shown in Figure 6-10 are typical of many commercial laser diodes, although many variations are possible. The term heterojunction in the figure and in the caption refers to thin layers in which there are junctions between materials of different composition. These changes in material composition help confine the light and reduce the losses.

The elliptical beam may be rounded by using lenses that have different focal lengths in the two directions perpendicular to the direction of propagation. This will produce a beam with a more circular profile. But the beam divergence will still be larger than that of gas lasers. Because of their larger beam divergence, semiconductor lasers have lower radiance (power per unit area per unit solid angle) than other lasers with the same output power. The larger beam divergence angle also means that the light from semiconductor lasers cannot be focused as well as the light from lasers with smaller beam divergence.

Materials Used in Semiconductor Lasers

We have described the use of gallium arsenide for semiconductor lasers. We now turn to a description of some of the many other materials that have been used for semiconductor lasers. The wavelength of the semiconductor laser emission may be varied over a large range by varying the composition of the material.

The most widely used semiconductor materials are the so-called III-V compounds, based on materials from columns III and V of the periodic table. Gallium arsenide is an example. But many more material compositions have been used, including ternary compounds, which contain three elements, such as $\text{Al}_x\text{Ga}_{1-x}\text{As}$; or quaternary compounds, which contain four elements, such as $\text{In}_x\text{Ga}_{1-x}\text{As}_y\text{P}_{1-y}$. These two compounds are commonly called aluminum gallium arsenide

and indium gallium arsenide phosphide, respectively. Here, both x and y are composition parameters that may each vary from zero to one independently. This allows for a wide range of material compositions with different values of band gap, index of refraction, etc.

These materials are usually grown as thin crystalline films on a crystalline substrate by a process called liquid phase epitaxy. Substrates may be materials such as gallium arsenide or indium phosphide. In this process, a mixture of materials with the desired composition is melted in contact with the substrate. Additional impurity elements may be added to make the material n-type or p-type. The melt is then cooled slowly, and the material in contact with the substrate re-solidifies in single crystalline form. The resulting crystalline films are then subjected to a number of processes—including etching, metal deposition, oxide deposition, polishing, and cleaving—to form the laser devices.

Table 6-1 presents some of the III-V compounds that have been used for lasers, along with the range of wavelengths that may be obtained using each compound. The materials in the table are often simply represented by their chemical symbols, not including the composition parameters x and y . Thus, aluminum gallium arsenide may be represented as AlGaAs.

Table 6-1. III-V Semiconductor Laser Materials

Material	Wavelength Range (nm)
Aluminum Gallium Arsenide	780–880
Indium Gallium Arsenide Phosphide	1150–1650
Aluminum Gallium Indium Phosphide	630–680
Indium Gallium Arsenide	around 980
Indium Aluminum Gallium Arsenide	780–1000
Gallium Arsenide Antimonide	1200–1500
Indium Arsenide Phosphide	1000–3100
Gallium Arsenide Phosphide	600–900

Of the materials in the table, the most widely used ones have been indium gallium arsenide phosphide (for communication applications), aluminum gallium arsenide (for data-storage applications, such as compact disc players) and aluminum gallium indium phosphide for shorter wavelength applications (such as replacements for helium-neon lasers).

The materials discussed so far emit light in the red and infrared portions of the spectrum. Applications requiring shorter wavelengths, in the blue or near-ultraviolet regions, use materials based on gallium nitride, such as aluminum gallium nitride ($\text{Al}_x\text{Ga}_{1-x}\text{N}$) or indium gallium nitride ($\text{In}_x\text{Ga}_{1-x}\text{N}$). The wavelengths available from these devices cover the range from 375 nm to 640 nm. They have become important in data-storage devices requiring high packing density and are described more below.

Other devices that have been demonstrated include diodes based on II-VI compounds (compounds from elements in columns II and VI of the periodic table). Examples are cadmium

sulfide selenide ($\text{CdS}_x\text{Se}_{1-x}$), which emits light in the 500–700 nm range, and cadmium zinc selenide ($\text{Cd}_x\text{Zn}_{1-x}\text{Se}$), which emits light in the 300–500 nm range. These devices have limited commercial availability.

Farther in the infrared range are lasers based on lead compounds, such as lead sulfide selenide, lead tin selenide, and lead tin telluride. Experimentally, laser operation has been demonstrated over a very wide range, out to about 30 μm . A small number of commercial devices operate at wavelengths near 5 μm .

Developments in Semiconductor Laser Types

Earlier, we showed a very simple gallium arsenide laser structure as an example of a diode laser. We now describe variations of diode laser structures that provide the same functions but with improved performance.

Advances in Laser Junction Structure

The simplest type of advanced junction structure is called a stripe structure. It is illustrated in Figure 6-11, in conjunction with a double heterojunction configuration. The configuration is called a double heterojunction because there are two junctions of different materials: one between GaAs (p-type) and AlGaAs (p-type) and another between AlGaAs (p-type) and AlGaAs (n-type). The active region of the laser is in the latter junction. The index of refraction is higher in the active region than in the materials adjacent to it. This situation increases the amount of laser light that reflects back into the active cavity, which increases the gain and lowers the threshold current needed for laser operation.

The stripe in this structure is the indentation in the top surface of the laser shown in Figure 6-11. This indentation runs the entire length of the structure, which makes it look like a stripe. An insulating coating, most often silicon dioxide, is evaporated on the surface of the device, and the stripe is formed through techniques like photolithography and etching. A metallic layer is then deposited to form a contact; the metal is in contact with the semiconductor only in the region of the stripe. As a result, the current in the semiconductor is limited to just this region, which leads to higher current densities and larger gains in the active region.

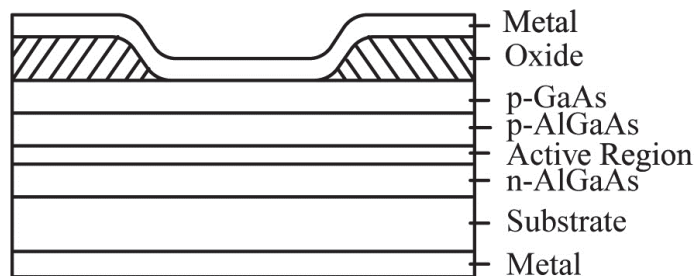

Figure 6-11 *Diagram of GaAs/AlGaAs laser with oxide stripe geometry*

This structure improves the electrical and optical confinement of semiconductor lasers and reduces the threshold currents required to operate them, thus increasing the output laser power. This is only one example of the many variations in semiconductor laser structures that have been developed, but it shows how changes in laser structure can improve performance.

High-Power Devices

Early semiconductor lasers had outputs in the range of milliwatts. This was adequate for applications such as compact disc players. But more recently, CW semiconductor lasers with outputs of hundreds of watts have become commercially available. And by combining the outputs of a number of semiconductor lasers, we can now obtain much higher output powers.

Single laser diodes with CW output well in excess of 100 W are now commercially available, and experimental models with even higher output have been demonstrated. Most of these high-power lasers are composed of aluminum gallium arsenide or indium gallium arsenide and cover the wavelength range from 770 nm to slightly longer than 1000 nm.

To reach even higher powers, more complicated structures are used. A number of lasers may be combined in what is called a bar. An example is shown in Figure 6-12.

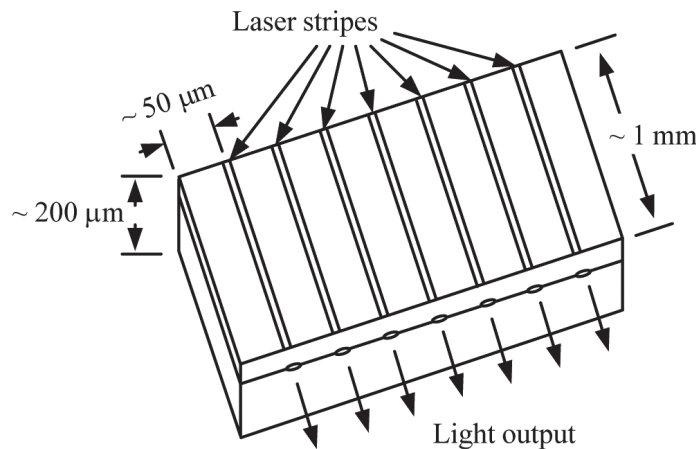

Figure 6-12 Diagram of a semiconductor laser bar

A bar may have as many as 100 diode lasers and a total output of hundreds of watts. Coupling between the adjacent lasers can keep them coherent and operating in a single spatial mode. Such bars are sometimes called arrays and are available in several commercial models.

To reach even higher powers, bars may be placed on top of one another. These structures are called stacks. Heat sinking elements are placed between the bars. To remove the heat, it is good for the heat sinks to be relatively large. But to keep the beam compact, the bars should be close together. Thus, the design of an array is usually a compromise between heat removal and beam quality.

A stack of semiconductor laser bars may have output in the multi-kilowatt range. Such semiconductor lasers can rival the output of very large material processing lasers, such as the carbon dioxide laser, but they can be much smaller and more efficient. The development of higher-power semiconductor lasers required overcoming two big obstacles: catastrophic optical damage to the faces of the lasers and overheating.

Later, this module will describe catastrophic optical damage, in which high power densities destroy the end facets of the laser. To avoid this optical damage, methods for reducing high power densities have been developed. These methods include spreading the beam over a larger area so that the power density is reduced and using facet coatings with very low absorption that engineers have developed just for this purpose. Additionally, engineers have developed

structures for removing the large amounts of heat associated with high-power lasers, thus eliminating one of the key factors that causes optical damage.

Distributed-Feedback Structures

So far, we have considered semiconductor lasers in which the mirror is formed by the coated or uncoated end facets of the semiconductor. In many modern lasers, feedback is caused by reflection from a structure of finite length. These structures are said to cause *distributed feedback*.

There are a number of types of distributed-feedback structures. Here, we describe two of them: *distributed-feedback lasers* and *distributed Bragg reflectors*. Both rely on a concept called *Bragg reflection*, which uses the periodic variation in some property of a material, such as thickness, to produce reflection. Bragg reflection occurs when the light passes through a structure consisting of multiple layers of alternating materials with different indices of refraction. It can also be caused by a periodic variation of some property, such as height, in a waveguide. At each boundary between successive layers with different properties, there is a partial reflection of the light. If the optical thickness of the layers is close to one-fourth of the wavelength of the light, the partial reflections can interfere constructively. The structure can serve as a high-quality reflector for a specific wavelength. If the laser's output has a broad spectrum, the reflector can select the wavelength that is four times the layer thickness and reflect that wavelength, thus acting like a narrow band filter.

In the distributed-feedback (DFB) semiconductor laser, there is a periodic corrugation in the active medium. This causes reflection and replaces the cleaved end mirrors. A DFB laser is illustrated in Figure 6-13a.

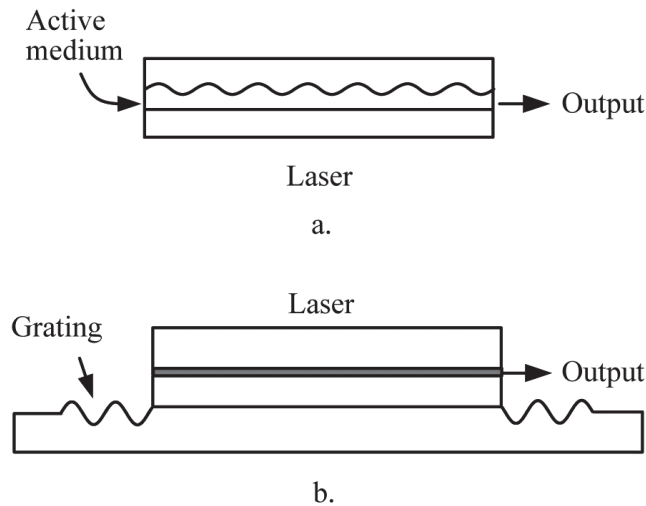

Figure 6-13 Diagram of the side view of: (a) a distributed-feedback semiconductor laser and (b) a distributed Bragg reflector

In the DFB laser, the entire laser cavity has a periodic structure that acts as a reflector.

A distributed Bragg reflector (DBR) is similar to the DFB device, both in construction and operation; see Figure 6-13b. But the periodic structure is a grating that is outside the laser's

active medium. This makes the device easier to fabricate. The gratings are at each end of the active medium and act as reflectors.

Both the DFB and DBR devices act as wavelength-selecting elements. The spacing of the periodic variations is chosen to select only a narrow band of wavelengths. Thus, they can reduce the spectral width of the laser output substantially, as compared to what was described earlier. Additionally, these devices allow the selection of a longitudinal mode from the spectrum.

If the temperature of the device changes, thermal expansion will change the spacing of the periodic variations, and the wavelength of the laser will change. Thus, if a stable wavelength is needed, the temperature of the laser must be controlled.

Vertical Cavity Surface Emitting Lasers

The lasers we have described so far emit their light from the edge of the laser structure and are called *edge emitters*. In recent years, engineers have developed semiconductor lasers that emit light from the surface of the structure. These lasers are called vertical cavity surface emitting lasers (VCSELs, pronounced “vixels”). VCSELs offer the user high power with a reduced threat of damaging the emitting surface. In part, this lower risk of damage is due to a larger emitting area. These lasers emit a circular beam with smaller divergence angle than edge emitters because there is less diffraction by the emitting area. Many different configurations have been developed for VCSELs. Figure 6-14 shows one example.

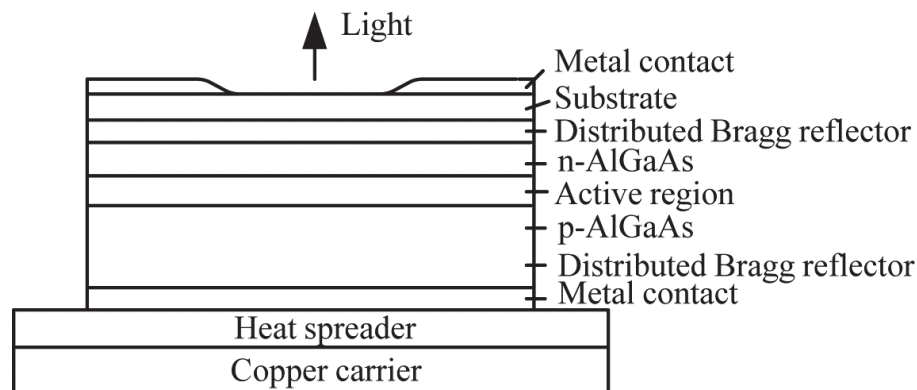

Figure 6-14 Diagram of one possible configuration for a VCSEL

In this diagram, the Bragg reflectors consist of many very thin layers of AlGaAs, with different doping levels in alternating layers. The active medium is a relatively thin layer perpendicular to the direction of the beam. The light emerges in a vertical direction. The beam may have a diameter up to a few hundred micrometers. Hence, its spread by diffraction is much less than the output from edge emitting semiconductor lasers. Also, because the area from which the beam emerges is much larger than for an edge emitter, the problem of catastrophic optical damage is much reduced. VCSELs have demonstrated very high reliability and low failure rates.

The development of modern VCSELs has taken decades, beginning in 1979. At first, there were production problems, some of which arose because of strain in the multiple thin layers of material required. But with continued development, those problems were solved. Now, thousands of VCSELs can be processed simultaneously from a single wafer.

VCSELs are compatible with high power and high efficiency. CW output power in excess of 200 W and wall plug efficiency greater than 60% have been demonstrated. VCSELs with different designs and different output characteristics have become commercially available from a variety of sources. They have replaced emitting semiconductor lasers in many applications. Some of these applications include cosmetic applications such as laser hair removal, pumping of solid state lasers (described below), cutting and drilling with high power, frequency doubling to produce green or blue light, and infrared illuminators for military use.

Short-Wavelength Semiconductor Lasers

The original semiconductor lasers were based on materials such as aluminum gallium arsenide and indium gallium arsenide phosphide. These lasers provided output in the red and infrared portions of the spectrum. For many years, scientists and engineers tried to develop shorter-wavelength semiconductor lasers that would operate in the blue and near-ultraviolet portions of the spectrum. Such lasers were intended for data-storage applications, such as optical memory, compact discs, and DVDs, because they could increase the packing density of the stored information. As a rough rule of thumb, laser light can be focused to a spot with dimensions approximately equal to its wavelength. Thus, a 400 nm laser beam can be focused to a spot about one-half the diameter to which an 800 nm laser beam can, and the area of the 400 nm spot will be about one-fourth the area of the 800 nm beam. Thus, the amount of data that can be stored in a given area will be four times as great with the 400 nm beam. Because of this potential increase in packing density, there was good reason to pursue the development of shorter-wavelength semiconductor lasers.

Many attempts were made to develop such shorter-wavelength lasers, but for many years, no really successful models were achieved. Scientists realized that the use of gallium nitride, a relatively wide-bandgap semiconductor and also a III-V compound like GaAs, could be the key to developing semiconductor lasers with short wavelength. But there were significant difficulties in preparing such lasers. One problem was in doping gallium nitride with a p-type dopant. Although it was relatively easy to prepare n-type gallium nitride, it took a number of years to develop good p-type gallium nitride, which is necessary for a p-n junction. A second difficulty was in the substrates for gallium nitride lasers. Aluminum gallium arsenide lasers can use gallium arsenide substrates, which crystal growers were able to prepare relatively easily. But gallium nitride has a high melting point, and the available substrate materials were materials such as sapphire and silicon carbide. These materials have crystalline structures that do not match that of gallium nitride. When gallium nitride crystals were grown on them, the mismatches in the crystals led to defects in the gallium nitride. These defects precluded the use of gallium nitride as a laser. After some years of work, crystal growers learned to prepare a thin “buffer” layer of aluminum nitride, which could allow the gallium nitride to be grown with fewer defects. Even with the buffer layer, the material still had more defects than was desirable, but it did finally allow gallium nitride lasers to be developed. Continued development of substrate materials led to techniques for effectively growing crystals of gallium nitride. The use of gallium nitride as a substrate further advanced the capabilities of short-wavelength semiconductor lasers.

The first gallium nitride laser was operated in 1995 at a wavelength near 420 nm. Soon, technology was developed to enable ternary compounds—aluminum gallium nitride and indium gallium nitride—to be used as lasers. The composition of the ternary compounds can be controlled so that the band gap may be varied. This allows the wavelength of the laser emission

to be selected. These lasers can operate from the near-ultraviolet through the violet, blue, and green portions of the spectrum.

Now, many manufacturers offer models of short-wavelength semiconductor lasers with wavelengths in the range from 375 nm to 520 nm and with CW power levels up to 100 W. Many CW models are available at wavelengths of 375, 405, 440, 445, and 488 nm. The availability of these short-wavelength semiconductor lasers has opened up many applications. Many of the commercial models, including those used in optical data storage and retrieval, operate at 405 nm. Applications of semiconductor lasers in general will be described later.

Damage Mechanisms for Semiconductor Lasers and Prevention of Damage

Semiconductor lasers are subject to damage from a variety of causes. The causes include:

- Catastrophic optical damage (COD). This involves destruction of the output faces of the laser when they are exposed to excessive optical power.
- Operation at excessive temperature.
- Electrostatic discharge.
- Transient current pulses during operation.
- Gradual aging.

Damage Mechanisms

Catastrophic optical damage is the most serious damage mechanism, and it often leads to complete destruction of the laser. This can occur if the output power becomes too high. Some of the light is absorbed at the surface. This causes heating, which increases absorption, leading to a feedback process that destroys the facet of the semiconductor.

As current is increased, the output power increases, as Figure 6-7 showed. But if the power becomes too high, COD occurs and output drops precipitously. The right end of the curve in Figure 6-7 would be replaced by a vertical drop of the output to zero.

Operation at elevated temperature substantially reduces the lifetime of a semiconductor laser. The failure rate for semiconductor lasers increases exponentially with increasing temperature. The fraction of a batch of semiconductor lasers that have failed after a specified number of hours of operation may increase by a factor of 5 for a temperature rise of 10 degrees Celsius. Cooling methods for semiconductor lasers have been discussed in the *Mounting and Cooling* section of this module.

Semiconductor laser diodes are very sensitive to electrical transients. Static electricity present in the work area may easily burn out laser diodes. A new user of laser diodes in a laboratory environment may well destroy a number of semiconductor lasers before learning to control static electricity. Excessive voltage, arising from power supply transients, can also destroy semiconductor laser diodes. Voltage spikes large enough to cause damage to laser diodes may occur during both turn-on and turn-off of power supplies. Such voltage spikes can “electrocute” semiconductor lasers.

Gradual aging leads to decreasing output with time and the need for increased current to maintain operation at a specified output. Both excessive temperature and excessive current can exacerbate gradual aging, but even without these factors, the output of a semiconductor laser will decrease with time. The dominant mechanism appears to be the presence of crystalline defects in the original material growth. After prolonged operation, there may be a buildup of damage around these defects. The progression of gradual aging can vary widely from one batch of laser diodes to another batch of the same composition. If the output power and current are kept reasonably low and the operating temperature is well controlled, the lifetime of semiconductor lasers can be quite long. Manufacturers have claimed, on the basis of accelerated aging tests, that it could exceed 100 years.

Methods for Limiting Damage

For semiconductor lasers in many of the widely used applications, such as compact disk players and DVDs, the conditions are well controlled. The current and operating power are effectively limited, and the power supplies are designed to have no current transients. The lifetime of such devices may be quite long. But many technicians will be working with semiconductor lasers in a laboratory environment. If you are one of these technicians, you may be assembling circuits with diode lasers or assembling power supplies for them, and you will need to know how to avoid the damage that can occur with improper handling.

The most important method is to ensure that the laser is not driven at too high a current. The technician must limit the current to the maximum value specified by the manufacturer. The power supply should have current-limiting features that do not allow the current to exceed the safe value.

To reduce the possibility of damage due to excessive temperature, the laser should be in good thermal contact with a heat sink that can dissipate the heat generated by the laser. Manufacturers usually mount higher power semiconductor lasers in water-cooled structures. The technician must ensure that the cooling system is operating properly.

Static-electricity hazards may be reduced in a number of ways. The technician should be well grounded by a high resistance (one megohm). The technician should wear a grounded wrist strap and a grounded foot strap when handling semiconductor lasers. The work area should be grounded, with grounded floor mats and conductive tops for worktables. Shoes should be of an antistatic type—that is, leather rather than plastic. If soldering is required, proper techniques are essential. The tip of the soldering iron should be grounded, and minimum heat should be used. Some manufacturers provide information on soldering techniques with their diodes.

The technician should ensure that the power supply is specially designed for use with laser diodes, that it has slow start-up features that reduce current transients, and that it does not produce transients when it is turned off.

Gradual aging cannot be eliminated completely. It basically arises from causes beyond the control of the technician. Still, the effects of gradual aging can be substantially reduced if the temperature and current of the diode are kept within proper limits.

Applications of Semiconductor Lasers

Semiconductor lasers offer important advantages compared with other lasers:

- High efficiency, up to near 50% in many cases.

- Compactness, with single diodes in packages of sub-centimeter size.
- Low power consumption—both voltage and current.
- High reliability and long life—up to tens of thousands of hours.
- Relatively low cost.

Because of these factors, semiconductor lasers have widespread usage in a very broad range of applications. Hundreds of millions of semiconductor lasers are manufactured and sold each year, the great majority in the areas of optical data storage and retrieval and optical telecommunications. These two applications are well established and are familiar to almost everyone. Because they are so well known, they will be discussed only briefly in this module.

Optical Telecommunications

Laser-based telecommunications systems are generally based on fiber-optics. Figure 6-15 shows an example of a typical optical fiber. A basic optical fiber consists of a core of high index material surrounded by a cladding of lower index material. Light injected into the core can be confined inside the core by total internal reflection, provided that the angle of injection α is small enough that the angle θ inside the core is greater than the critical angle θ_c for total internal reflection. Meeting the conditions for total internal reflection allows the light to move through the fiber with minimum losses.

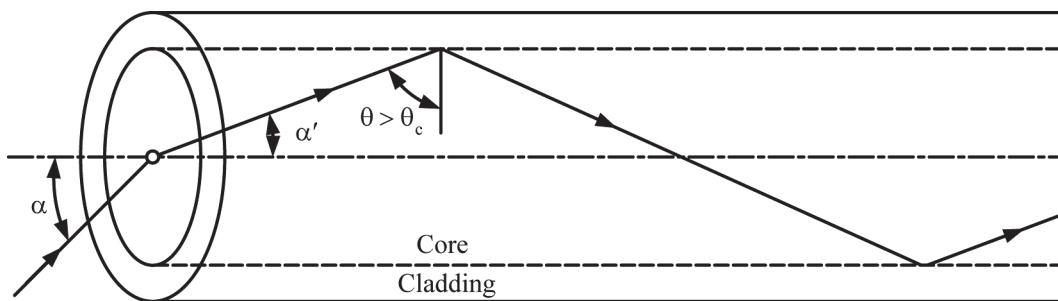

Figure 6-15 Injection of light into the core of an optical fiber

For many decades, engineers knew that it was possible to transmit light through optical fibers. But the losses in optical fiber transmission were very high—around 1000 decibels (dB) per kilometer (km). So only short transmission lengths were possible. Early fiber-optic instruments included medical instruments for viewing internal structures in the human body.

During the 1960s, after semiconductor lasers had been developed, scientists recognized the potential of coupling semiconductor lasers to optical fibers for communications purposes. They knew that contaminants in the glass caused much of the loss, so an intense effort was launched to reduce the contaminant level. This effort succeeded and substantially reduced the fiber losses. The loss in optical fibers was reduced by orders of magnitude, so that optical fibers could be used for long-distance communication.

By about 1980, a commercial fiber-optic communication system had been developed. It used gallium arsenide lasers operating at a wavelength around 800 nm. It was suitable for intercity use, with a range between repeaters (devices which amplify and clean up the signal) up to 10 km.

Further development has reduced fiber loss even further. Figure 6-16 shows attenuation for a silica-based optical fiber as a function of wavelength. The regions marked “intrinsic scattering” and “intrinsic absorption” represent losses inherent to the glass that cannot be reduced by further reduction of contaminants. The region marked “typical range” is the region in which fiber losses can be controlled. The minimum loss is in the region near 1550 nm. The loss can be about 0.15 to 0.3 decibels per kilometer in that region. Indium gallium arsenide phosphide lasers can be built to produce light with a wavelength of 1550 nm. Most current long-distance optical fiber telecommunications systems use this wavelength.

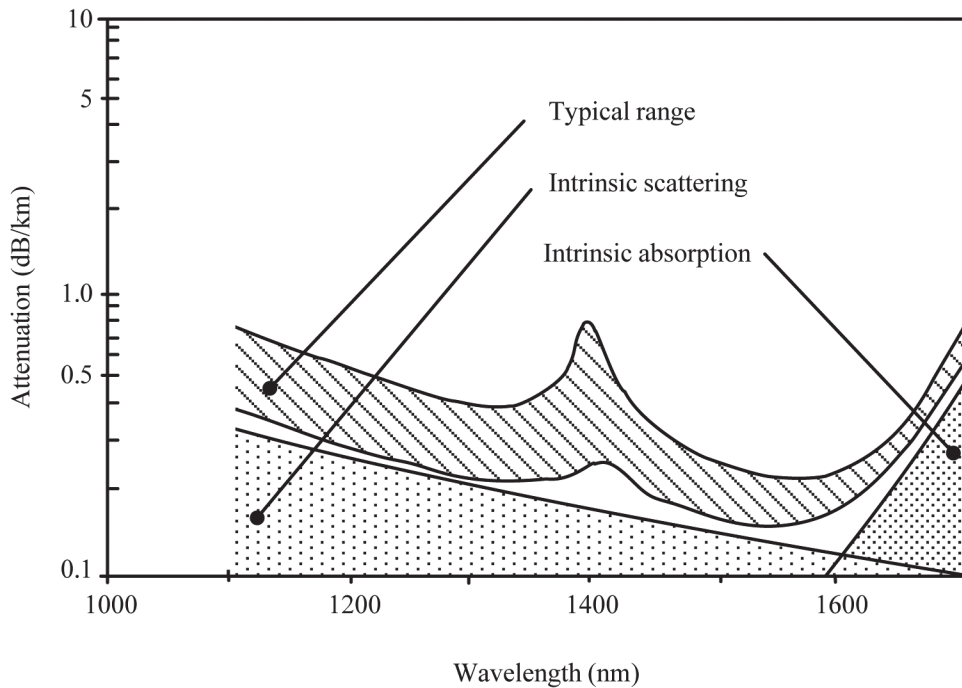

Figure 6-16 Loss as a function of wavelength for optical fibers

Figure 6-17 shows a schematic of an optical fiber, laser-based telecommunications system. The digital signal is used to modulate a semiconductor laser in pulse-code modulation (that is, a sequence of ones and zeros). The laser pulses are inserted into an optical fiber. The connector involves a direct coupling of the emitting area of the laser to the core of the fiber. Repeaters include a detector, a signal processor to amplify and restore the pulse shape of the laser pulse, drive circuitry, and a laser to retransmit the pulse. Signals are typically recovered and retransmitted by a repeater after a loss of 50 dB. A fiber has a loss of 0.2 dB/km, so repeaters may be spaced at distances greater than 200 km. At the receiving end, another detector, amplifier, and signal regenerator recover the signal shape and send the digital signal on to its destination.

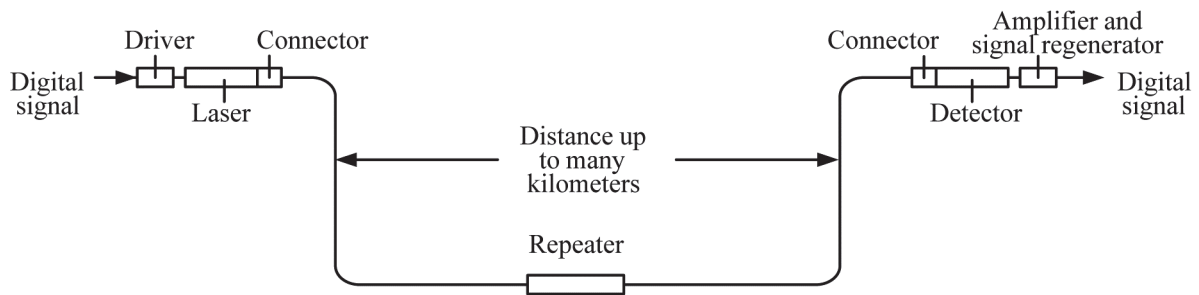

Figure 6-17 Example of a laser-based optical fiber telecommunications system

The example in Figure 6-17 represents a long-distance communications system. This type of configuration has been deployed in many hundreds of thousands of miles of long distance systems, including undersea cables. Similar systems are used in local area networks and in intracity networks, where repeaters are not needed. Many systems employ data transmission rates of up to 40 gigabits per second.

Laser-based optical fiber telecommunications offer many advantages. For local area networks within a building, a single optical fiber can carry more data than a single electrical cable. Optical fibers can be bundled as cables, which can be inserted into a duct that formerly could carry one electrical cable. This increases the capacity of crowded intracity networks. For longer-distance communications, optical signals have less attenuation than electrical signals, so fewer repeaters are needed.

Optical fiber is immune to electrical interference. It is also much more immune to wiretapping than electrical connections. Thus, laser-based optical fiber data transmission has become extremely important.

For more details on how lasers are used in telecommunications, go to The National Center for Optics and Photonics Education (OP-TEC) website (www.op-tec.org) and download a copy of the Photonics-Enabled Technologies (PET) series publication entitled *Principles of Fiber-Optic Communication*.

Optical Data Storage and Retrieval

Development of laser-based optical data storage began in the 1960s, shortly after the first lasers were operated. Scientists recognized that creating a pattern of bits in some storage material could lead to a very high packing density for information in the material, which exceeded then available magnetic storage. The original motivation was to create high-capacity computer memories. By the late 1960s, complete optical storage systems had evolved that were capable of recording, reading, erasing, and rewriting data bits. These systems used helium-neon lasers and magneto-optical recording materials.

Later, the emphasis shifted from computer memories to entertainment: music, video, and games. The first commercial products, audio compact discs, came on the market in the early 1980s. These were prerecorded read-only devices that used AlGaAs semiconductor lasers operating at a wavelength near 780 nm. The data bits were recorded in the form of pits in circular tracks around the center of a rotating disc. The presence of a pit changed the amount of light reflected to a detector. The presence or absence of a pit in a particular location indicated either a one or a

zero bit. Such discs have become familiar to everyone as compact discs (CDs). Consumer acceptance of CDs was immediate.

Such laser-based systems offered advantages over other earlier devices such as phonograph records and tape-based systems. The advantages included:

- Freedom from damage, because nothing touches the surface of the disc.
- Smaller size.
- Very low distortion.
- Low sensitivity to vibration.
- Tolerance of defects such as small scratches and fingerprint marks.

As time went on, compact discs were largely supplanted by DVDs. The term *DVD* actually does not stand for anything: it is simply a name that was chosen. But in the popular mind, it means *digital video disc*. DVD systems use a semiconductor laser with a wavelength of 650 nm. The shorter wavelength allows more data to be stored on a given area; the packing density for data is inversely proportional to the square of the wavelength. Other design features allow greater amounts of data to be stored, so the total data capacity of DVDs is substantially higher than that of CDs.

Blu-ray systems also use semiconductor lasers. These systems use gallium-nitride-based semiconductor lasers operating at a wavelength of 405 nm. This shorter wavelength increases the data density substantially and allows for HD recordings and viewing.

Optical memories have developed into many different designs and formats—far too many to describe fully. We may distinguish three main varieties:

- Read-only memories.
- Write-once, read-mostly (WORM) memories.
- Rewritable memories.

In read-only memories, the data are prerecorded, and the user simply plays them. These devices are mostly used for entertainment.

WORMs use a disc that is coated with a material that melts at a low temperature. The laser melts a hole in the material, and that changes the reflectivity at that spot. Once recorded, the information can be read, but not erased. Such devices are used to store data that must be kept secure. They have been used to record data for banking, for the health care industry, and for archival storage of large amounts of data.

In rewritable memories, the data may be recorded, erased, and rewritten many times. These discs have a coating of a magneto-optic material. The magnetization of the material is changed when the laser beam strikes a spot. The data are read when the spots are struck by the same laser with reduced power. The polarization of the reflected beam is changed by the differences in magnetization of the material, and that change is sensed by a detector system. The data may be changed by re-irradiating the spots with higher power. Such devices have been useful in storage-intensive applications such as desktop publishing.

There are far too many configurations of optical memories to describe in this module. As a single example, Figure 6-18 shows the configuration of a write-once, read-mostly memory. The

modulator allows the light reaching the surface of the disc to be at a high irradiance when a bit is to be recorded. A pit is then burned into the low reflectivity material on a reflecting substrate. When the material is removed, light is reflected well by the reflecting material. The change of reflectance shows the presence of a pit at the position where the material was removed.

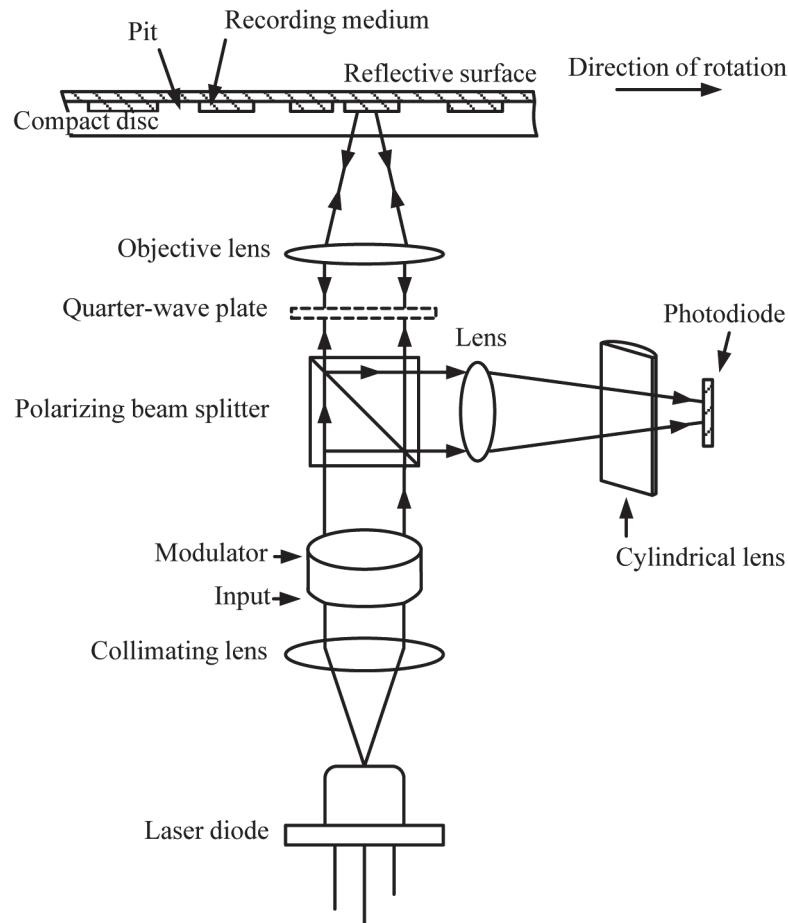

Figure 6-18 Example configuration for a write-once, read-mostly optical memory

When the data are to be read, the laser power is reduced. The quarter-wave plate (a device that alters the polarization state of light) rotates the plane of polarization by 90 degrees after a double passage through it. The reflected light is sent through the polarizing beam splitter to the photodiode. The change of reflectance shows the presence of a pit at the position where the material was removed and thus indicates whether a one or a zero bit is at that position. In this way, all the ones and zeros along the track may be identified.

The availability of small, compact, and efficient semiconductor lasers has made possible many different forms of optical data recording and has revolutionized many areas of entertainment.

For more details on how lasers are used in data storage, go to The National Center for Optics and Photonics Education (OP-TEC) website (www.op-tec.org) and download a copy of the Photonics-Enabled Technologies (PET) series publication entitled *Photonic Devices for Imaging, Storage, and Display*.

Diode-Pumped Solid State (DPSS) Lasers

Semiconductor lasers provide high efficiency for conversion of electrical energy to optical energy. Thus, the use of semiconductor lasers to pump solid state lasers, such as Nd:YAG lasers, can offer advantages over flashlamp or arc lamp pumping. The composition of the semiconductor laser may be chosen so that its wavelength matches a strong absorption of the solid state laser material. Figure 6-19 shows the absorption spectrum of Nd:YAG and the emission spectra of some pump sources. A flashlamp may have a broad continuum spectrum like a black body so that much of its energy falls in regions where the Nd:YAG does not absorb. The Kr arc lamp has line emissions in regions where Nd:YAG does absorb, so it can be more efficient than a flashlamp. The wavelength of a semiconductor laser may be adjusted, by composition and temperature, to exactly match the wavelength of a strong absorption line. The line width of a semiconductor laser is larger than that of many other lasers, as we have seen, but it still is narrower than the width of the absorption line. Thus, essentially all the energy from the diode laser is used to excite the Nd:YAG.

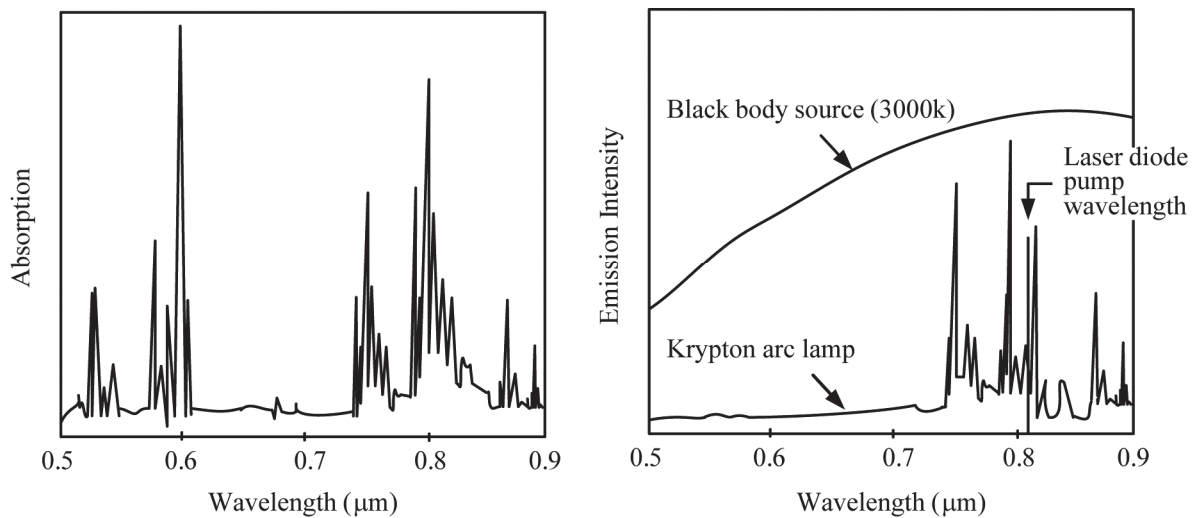

Figure 6-19 Left: Absorption spectrum of Nd:YAG. Right: Emission spectra of pump sources compared with the Nd:YAG absorption spectrum.

One of the strongest absorption lines of Nd:YAG is at 808 nm, a wavelength that the AlGaAs semiconductor laser can produce. Because the efficiency of the semiconductor laser may be 50% or more and all of its energy is used to pump the Nd:YAG, the efficiency of the semiconductor diode-pumped Nd:YAG laser may be in the range of 25% or even greater, as compared with the small percentage possible with other pump sources. This also means that the amount of waste heat and the amount of cooling required are much reduced.

Why would one want to use the diode laser to pump a Nd:YAG laser rather than using the diode laser directly? The reason is that the quality of the beam from the Nd:YAG laser is better than that of the diode laser. We have seen that the diode laser typically has larger beam divergence and wider spectral width than other lasers. Thus, one may sacrifice some of the total power from the diode laser to produce a beam with higher radiance (power per unit area per unit solid angle, also called brightness). Diode pumping a solid state laser may be regarded as a “brightness amplifier.” Many models of diode-pumped solid state (DPSS) lasers are commercially available. Many more diode-pumped solid state lasers are now commercially available than older solid state lasers pumped by other sources.

It is possible to include a nonlinear optical material in the cavity with the Nd:YAG. Figure 6-20 shows an example. The Nd:YAG is end-pumped and produces an output at 1064 nm. The nonlinear doubling crystal doubles the frequency and halves the wavelength to 532 nm. The arrangement of the mirrors allows only the 532 nm light to emerge as output.

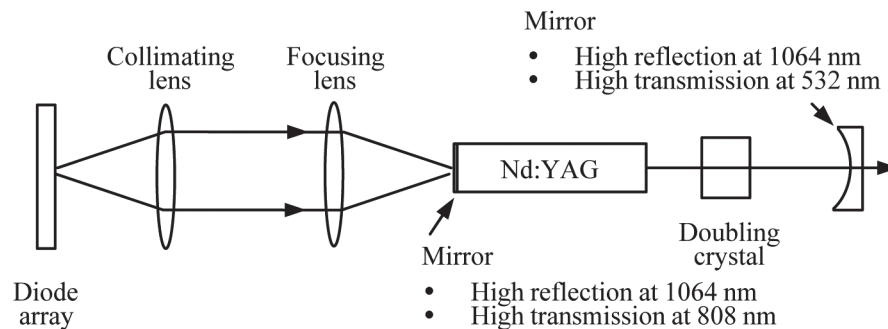

Figure 6-20 Configuration for an end-pumped, diode pumped intracavity-doubled Nd:YAG laser

It is possible to frequency double, triple, and quadruple diode-pumped Nd:YAG lasers. Thus, diode-pumped Nd:YAG lasers with wavelengths of 1064, 532, 355 and 266 nm are all commercially available.

The most common DPSS laser has been Nd:YAG, but there are many other types of DPSS lasers. These include Nd-doped yttrium lithium fluoride (Nd:YLF) at wavelengths of 1047 and 1320 nm, Nd-doped yttrium vanadate at 1340, 1064 and 532 nm, ytterbium-doped YAG at 1030 nm, and erbium-doped glass fibers at 1535 nm (fiber lasers will be discussed shortly). DPSS lasers with other types of nonlinear optical effects (such as frequency addition or subtraction) are available with wavelengths of 473, 488 and 561 nm. For more information on Nd:YAG lasers, go to Module 2-8 in this course.

Figure 6-20 illustrates the configuration of a DPSS laser. It is an end-pumped configuration with the pump light striking the laser material from the rear, through the mirror that defines the laser cavity. As the figure shows, this mirror is coated for high transmission of the pump light. This configuration is commonly used for relatively low-power DPSS lasers with output powers up to perhaps 30 W.

But for higher output power, the end-pumped configuration is not suitable. A relatively large volume of the solid state laser material is needed, and the pump light is absorbed too strongly to excite the entire volume uniformly. Higher-power DPSS lasers use side pumping. In this configuration, a number of diode laser bars are positioned radially around a rod of the solid state material. Side pumping allows a large number of pumping sources to be used. This allows a DPSS laser to have multikilowatt outputs. A disadvantage of side pumping is that it may provide somewhat poorer beam quality than end pumping.

A variant of end-pumped DPSS lasers is the so-called microchip laser. A very small piece of Nd:YAG or Nd:YVO₄ is the laser medium. It is in the laser cavity with a frequency doubling crystal. The chip of lasing material may have dimensions around 2 × 2 × 0.5 mm. Such lasers can be very small and can produce output powers around 100 mW at 532 nm. These lasers have been used for applications such as green pointers.

To summarize, DPSS lasers offer a variety of advantages over solid state lasers pumped by other sources:

- High efficiency (up to 50%).
- Excellent beam quality.
- Very small size.
- Low excess heat.
- Scalability to high power.

Fiber Lasers

The developments in semiconductor diode lasers have also made possible another class of lasers: fiber lasers. This module will discuss fiber lasers briefly, since Module 2-5 was devoted entirely to fiber lasers. In a fiber laser, the gain medium is a long fiber doped with a rare earth element, such as neodymium, erbium, or ytterbium. Figure 6-21 shows a simple diagram of a fiber laser. Light from a semiconductor laser is inserted into the fiber through a dichroic mirror (a mirror that has different values of reflectivity at the pump wavelength and the laser output wavelength). The pump light is absorbed in the core of the fiber and produces laser light that emerges from the right end of the fiber. The fiber can be coiled multiple times, allowing for a very long length of gain material in a relatively small space. In a variation of Figure 6-21, multiple semiconductor lasers may be used to pump the fiber through a number of input fibers connected to a fiber coupler.

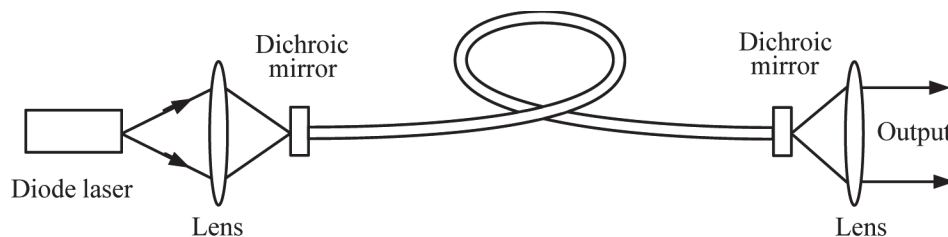

Figure 6-21 Simple diagram of a fiber laser

Fiber lasers offer advantages over other types of lasers. Because the gain medium is long and thin, it is easily cooled; air cooling is adequate except when the power gets very high. Their efficiency is high, and their drive-power requirements are relatively low. They require very little maintenance. They can be scaled to higher power simply by increasing the length of the fiber. The beam emerging from a fiber laser can be a single spatial mode with high beam quality. They essentially convert light with low brightness from semiconductor lasers to a high brightness output.

One kind of fiber laser uses an ytterbium-doped fiber, which can be pumped by light of around 915 nm in wavelength, which is available from semiconductor lasers. Ytterbium fibers then emit at a wavelength near 1100 nm. Neodymium fiber lasers may emit at a wavelength near 1400 nm, and erbium fiber lasers emit in the range of 1550 nm. Thulium fibers emit in the range from 1800 to 2100 nm.

Early fiber lasers had power outputs of a few watts. Now, high-output power levels in the multikilowatt range are available. Fiber lasers have also been used to generate very short pulses with durations in the femtosecond (10^{-15} s) range.

High-power fiber lasers have been used for materials processing applications such as marking, cutting, welding, and resistor trimming.

Replacement for Helium-Neon Lasers

Many applications developed early in the history of lasers used helium-neon lasers and involved measurements of various types. Semiconductor lasers, especially AlGaInP lasers operating in the red portion of the visible spectrum, have now replaced helium-neon lasers.

Applications for which semiconductor lasers have supplanted helium-neon lasers include measurement of vibration, detection of defects in manufactured products, alignment and positioning in manufacturing and construction, bar-code readers, and distance measurement.

The small size, efficiency, low power requirements, and low cost of semiconductor diode lasers have made them more attractive for many applications of this type.

Materials Processing

At one time, carbon dioxide and Nd:YAG lasers dominated laser-based materials processing. These lasers were the best candidates for applications such as marking, heat treating, welding, cladding, and cutting. High-power semiconductor lasers have changed this. Multikilowatt semiconductor lasers are now available to process metallic materials in manufacturing environments. High-power semiconductor diode stacks have been used for these processes in factory settings. With commercial lasers, it is possible to produce focused spots with irradiance approaching 1 MW/cm^2 .

Light from semiconductor lasers operating at a wavelength around 805 nm has a higher absorption coefficient than the light from carbon dioxide and Nd:YAG lasers. This makes semiconductor lasers preferable for applications such as processing of metals.

Semiconductor lasers have also been used to produce hardened surfaces on many different types of parts. During surface hardening, the laser heats the surface quickly. Once the irradiation ceases, the surface cools rapidly and the crystalline microstructure of the surface undergoes a phase transition to a different, harder phase. Semiconductor laser irradiation can produce high values of surface hardness in materials such as carbon steel, to a depth of around 2 mm. This is useful for manufactured components such as cutting surfaces and valve seats, which require high values of surface hardness.

High-power semiconductor lasers have also been used to weld metals. One example is the use of a 4 kW semiconductor laser to weld stainless steel tubing in a factory environment. And in the automotive industry, high-power diode lasers have been used to cut and mark sheet metal.

As these examples indicate, high-power semiconductor lasers are suitable replacements for carbon dioxide and Nd:YAG lasers in materials processing applications.

For more details on how lasers are used in materials processing, go to The National Center for Optics and Photonics Education (OP-TEC) website (www.op-tec.org) and download copies of the Photonics-Enabled Technologies (PET) series publications entitled *Laser Welding and Surface Treatment* and *Laser Material Removal: Drilling, Cutting, and Marking*. Other PET series modules that are related to materials processing include *Lasers in Testing and Measurement: Alignment, Profiling, and Position Sensing* and *Lasers in Testing and Measurement: Interferometric Methods and Nondestructive Testing*.

Medical and Dental Applications

Semiconductor diode lasers have been used in medicine and dentistry for a number of applications. One application that has become widespread is hair removal. Another application is whitening of teeth. A diode laser can be used to activate a gel in tooth-whitening treatment in a dentist's office. Dentists can also use a diode laser to remove calcified deposits as they clean teeth.

Dentists have used soft-tissue surgery to remove tumors and lesions from soft tissues of the mouth. The diode laser beam can kill bacteria, so it has been used to sterilize areas of the mouth before root canals and other treatments.

For more details on how lasers are used in medical applications, go to The National Center for Optics and Photonics Education (OP-TEC) website (www.op-tec.org) and download copies of the Photonics-Enabled Technologies (PET) series publications entitled *Lasers in Medicine and Surgery*, *Therapeutic Applications of Lasers*, and *Diagnostic Applications of Lasers*

Summary

The active medium of a semiconductor laser is the junction region between a p-type material and an n-type material. Laser light is a result of stimulated emission produced by electrons giving up their energy through combination with holes in the junction region. The pumping mechanism for these lasers is a forward biased voltage across the diode that reduces the intrinsic electric field at the diode junction allowing an increase in current through the diode. The feedback mechanism (cavity) usually consists of the cleaved ends of the diode.

This module has described the output characteristics of laser diodes and the ways they vary with temperature and current. We have described the spectral and spatial characteristics of semiconductor lasers, as well as how these characteristics differ from those of other types of lasers.

The module has defined ternary and quaternary compounds and has given examples of the numerous chemical compositions that have been used for laser diodes and the spectral ranges of their output.

Semiconductor diode lasers have many industrial applications. Structures such as heterojunctions and vertical cavity surface emitting lasers provide a base for developing many types of devices. Shorter-wavelength devices, operating around 400 nm, have many data-storage applications. High-power semiconductor lasers, in the multikilowatt range, have capabilities similar to the carbon dioxide and Nd:YAG lasers in materials processing applications; they can also be used to pump solid state lasers and fiber lasers.

The module has also described mechanisms by which semiconductor lasers are damaged and methods for avoiding damage.

SAFETY CONSIDERATIONS

Safety considerations for diode lasers are much different than for other laser systems, such as CO₂, Fiber, Argon, Nd:YAG and Excimer . In many diode laser applications, such as Optical Fiber Communications Systems (OFCSs), the laser is contained in an enclosed system and would be rated as Class I, no hazard controls necessary. In the OFCS example, radiant energy is confined in the core of a fiber-optic cable and is inaccessible to the user—posing no hazard. However, when and an optical connector is removed, usually during servicing of the cable, or a break occurs in the cable, it is conceivable that all of the radiant energy can impinge on the eye and hazard controls are necessary. Because the radiant energy emitted from an optical fiber has a high divergence, the risk for injury is much less than a conventional laser with the same operating power and wavelength.

Most diode lasers are rated as Class 1, Class 3R or Class 3B. However, there are vertical cavity surface emitting laser systems [VCSELs] that could be classified as Class 4. Normally emission from a Class 3B or Class 4 laser can cause injury to the eye, but again due to the relatively large divergence of a laser diode, the hazard potential is less. The exception to this lower hazard potential is when lens connectors are used to collimate the beam as in laser pointers. In this case, the hazard potential increases significantly.

Example 1

A person is exposed to light from a diode laser emitting at a wavelength of 1525 nm. The exposure lasts for 5 s. Below what irradiance level must this laser operate to ensure no damage results in the eye?

The ANSI Z-136.1 standard lists maximum permissible exposures (MPE) for various wavelengths of light. From this source, we find the MPE is 1.0 J/cm² for light at a wavelength of 1525 nm. This represents the energy per square centimeter a human eye can absorb at a wavelength of 1525 nm before damage occurs. To determine irradiance limits, we must convert the MPE from energy units (joules) to power units (watts). This is done by dividing the ANSI MPE by the exposure time.

$$\text{Laser irradiance limit} = (1.0 \text{ J/cm}^2)/5 \text{ s} = .200 \text{ W/cm}^2 \text{ or } 200 \text{ mW/cm}^2$$

Thus, if the diode laser has an irradiance of less than 200 mW/cm², the eye will not sustain damage for this exposure.

A typical danger sign used for diode lasers should say:

**“DISCONNECTED OPTICAL CONNECTORS MAY EMIT OPTICAL ENERGY
AVOID DIRECT EXPOSURE TO THE BEAM”.**

We should also mention several non-beam hazards, such as an eye-loupe or hand magnifier, that can concentrate the beam causing injury to the eye. Non-beam hazards such as: glass particles from a fiber, particularly from cleaving, could enter the eye and cause injury. Also, when using solvents and other chemicals for stripping and cleaning fiber elements, use a well-ventilated

area to avoid breathing harmful fumes (ANSI Z-136.2). Always consult your laser safety officer (LSO) when questions arise related to the safe handling and operation of a laser.

TROUBLESHOOTING

Diode Laser Maintenance & Troubleshooting

The following information on maintenance and troubleshooting applies uniquely to diode lasers and their external components, such as lenses, gratings (to select a specific wavelength), and fiber-optics delivery systems. It is essential that photonics systems technicians (PSTs) obtain user manuals and become familiar with the manufacturer's specifications for diode laser systems.

Typical Diode Laser System Parameters

Beam Mode / Gaussian Fit / Beam Divergence

Diode lasers have a highly diverging elliptical beam and therefore must be “shaped” to have an appropriate Gaussian Fit (TEM_{00} or M^2 near 1) and to minimize beam divergence. This is accomplished with optics, or an optical system, such as collimating lenses, micro-optics, and/or anamorphic prism pairs. Collimating the output beam enables it to be transmitted over long distances or more efficiently coupled into an optical fiber.

Troubleshooting Recommendation: Using a beam analyzer, check the diode laser's mode and divergence. If the mode and divergence are not in compliance with the manufacturer's specifications, adjust the beam-shaping optical system to correct this.

Beam / Power Delivery

Some laser diode modules are fiber coupled such that the output beam is directed into an optical fiber. These are frequently referred to as “pig-tailed” laser diodes.

Troubleshooting Recommendation: Using a beam analyzer, determine whether the mode of the fiber-coupled diode laser is within specification. If not, investigate this component for proper alignment. A misalignment of the fiber-optic “pig tail” will decrease the power out of the fiber.

Power / Operating Voltage (VDC)

A laser-diode module may contain not only simple connections to the pins of the laser diode, but also additional electronic circuit elements to protect the laser diode from electrostatic discharge, incorrect poling, and high operating voltages.

Troubleshooting Recommendation: A diode laser requires a certain level (bias) of DC voltage to operate or turn on the laser. If the laser does not operate, a quick check with a volt-ohm meter will determine whether the correct level of DC voltage is present. The technician should be aware of the diode laser's electrostatic discharge (ESD) sensitivity and take the necessary precautions when working with these units.

Operating Temperature / Wavelength Control

Temperature control and stability are critical to proper operation of diode lasers. A high-power laser-diode module can be cooled by attaching it to a metallic surface mounted on a cooler. A thermoelectric cooler (TEC) may also be used; a feedback system can be used to stabilize the diode temperature. This leads to a more stable output wavelength and power. The wavelength of the diode laser may be altered by a temperature change, at a rate usually equal to 1 nm per 3°C

change. Therefore, to change the output wavelength of a 810 nm C-rated diode laser (operating at 25°C) to pump a Nd:YAG rod at 808.5 nm, the TEC would need to lower the diode temperature to around 20.5° C.

Troubleshooting Recommendation: Use a spectrum analyzer to find out whether the output wavelength of the diode laser is correct. If it isn't, change the temperature of the diode so that the output wavelength meets specifications.

Output / Power Stability

The output power of a diode laser may be stabilized by using an internal feedback loop monitored by a photodiode, which is often built into the actual laser diode.

Troubleshooting Recommendation: If other reasons for power loss are not evident, it may be that the internal feedback loop is not operating according to expectations. Usually, the feedback loop is inside the unit's power supply, and a qualified electronics person will need to check it out.

Additional troubleshooting procedures may be found on the manufacturer's website.

LABORATORY

Laboratory 2-6

Diode Laser Operations and Measurements

Purpose

The purpose of this lab is to operate a diode laser and use a diode laser test station to make critical laser parameter measurements.



Safety Precautions

1. Safety precautions should always be practiced when working with any type of laser. Because the eyes are most vulnerable, safety considerations must begin with protection of the eyes. You **MUST** never look directly into the aperture of any laser. You must also avoid specular reflections of laser beams. Some diode lasers emit invisible radiation; therefore, you may not see radiation that could hurt your unprotected eyes. This is why it is important to always control the laser beam. Wear safety glasses when working with any un-terminated laser beams. Make sure that the beam is properly terminated into a nonreflective beam stop before you remove your safety glasses. Again, never look directly into the beam of a laser!
2. Diode lasers are susceptible to internal damage as a result of electrostatic discharge. ESD damage may be latent and so not immediately apparent. In other words, the diode laser may fail later as a result of previously encountered ESD. It is very important to take special precautions to avoid introducing the diode laser to ESD. Precautions include working on a grounded ESD mat and wearing a grounded ESD wrist strap.

Equipment

1. Newport LDKIT-1.5A-TO (includes 6100 diode laser driver and temperature controller, 710 mount, cables, post, post holder, fork clamp, and grounding wrist strap)
2. LDKIT-1.5A-TO User Manual
3. Diode laser (i.e.; Newport HL6320G TO-9 diode laser (10 mW, 635 nm))
4. Diode specification data sheet
5. Digi-Key “16-1206-ND” ESD Bench Top Static Control Grounding Mat
6. Coherent Field Mate Power MeterOP2Vis Detector Kit
7. DataRay Beam Analyzer
8. Ocean Optics Red Tide Spectrometer
9. Digital multimeter (DMM)
10. Thermocouple (Fluke 80TK)
11. HeNe laser
12. Thorlabs “LG7” Teal Lens Laser Safety Glasses
13. DataRay Wedge Beam Splitter 3 -10% (CUB)

Pre-Lab Familiarization

1. Answer the following questions about electrostatic discharge (ESD) mats.
 - a) Why is an ESD mat used with this piece of equipment?
 - b) What is the first thing you should do before handling a diode laser?
2. Read the specification data sheet for the diode laser and record the following information:
 - a) Wavelength = _____
 - b) Expected output power = _____
 - c) Maximum operating current = _____
 - d) Operating temperature range = _____
 - e) Diode laser package pin configuration
 - I. What is the polarity of the diode laser?
 - i. Diode laser pin = _____
 - ii. Diode laser cathode or anode out?
 - II. What is the polarity of the photo diode?
 - i. Photo diode pin = _____
 - ii. Photo diode cathode or anode out?
 - III. Diode laser & photo diode common pin = _____

3. Read the following manuals:
 - a) Coherent Field Mate Power MeterOP2Vis Detector Kit User Manual.
 - b) DataRay Beam Analyzer User Manual.
 - c) Ocean Optics Red Tide Spectrometer User Manual.
 - d) LDKIT-1.5A-TO User Manual.
 - e) Model 710 diode laser mount user manual.
4. Follow the Model 710 diode laser mount instructions to properly wire the mount and to properly insert the diode laser into the mount with respect to polarity. **It is extremely important to make sure that the mount is correctly wired and that the diode laser is properly oriented before applying power to it!**

Procedures

1. Set-up the diode laser (DL) test station according to the user manual and the diode laser specifications.
2. Once the diode laser is functioning, develop a technique for using a power meter to measure the output power of the diode. **(Caution: Make sure you do not exceed the power meter's maximum input power!)**
3. Determine the threshold current of the diode laser, and compare the reading to the specification of the diode laser.
 - a) Is it within specification? _____
 - b) Threshold current = _____
 - c) Explain what “threshold current” is:
4. What is the diode laser output power for the following input drive current levels?

Data Table 1

DL Input Drive Current (mA)	DL Output Power (mW)
10	
20	
30	
40	
45	
50	
52	
54	
56	
58	
60	
62	
65	

- a) Compare the readings to the specification of the diode laser. Are they within specification? _____
5. Plot a graph of output power versus input drive current recorded in Data Table 1. Attach the plot to the completed lab report.
 6. While measuring the case temperature of the diode laser, use the spectrum analyzer to measure the output wavelength of the diode laser. **(Caution: Make sure you do not exceed the spectrum analyzer's maximum input power!)** Compare the measured wavelength to the diode laser specification. Is it within specification? _____
 7. Use the spectrum analyzer to measure the output wavelength spectrum of an HeNe laser. Compare the spectrums of the diode laser and the HeNe laser. Describe the differences and similarities.
 8. Use the bandwidths of the two lasers to calculate their coherence lengths.
 - a. HeNe coherence length = _____
 - b. Diode laser coherence length = _____
 9. Use the spectrum analyzer to measure the output wavelength of the diode laser at different case temperatures (a minimum of 5 different temperatures). Adjust the temperature controller and diode laser drive current to obtain different case temperatures. Record your results in the Data Table 2 below for a minimum of five output wavelength readings.

Data Table 2

DL Case Temperature (°C)	DL Output Wavelength (nm)
25	
26	
27	
28	
29	
30	
31	
32	
33	
34	
35	
36	
37	
38	
39	
40	

- a) Explain why the wavelength varies with temperature.

- b) Name one application in which it would be very important to maintain a constant output wavelength from the diode laser, and explain why.
10. Use a beam profiler to measure the beam divergence and ellipticity for both the HeNe and diode lasers.
- a) **Use the procedures in Attachment 1, beginning on page 42, to make certain that the beam energy of the lasers does not exceed the maximum allowable input energy of the beam profiler. If the maximum allowable input energy is exceeded report this to your instructor. Do not proceed with this laboratory until you have permission from your instructor. If the maximum allowable input energy is not exceeded, then proceed with the following steps:**
- b) Initiate the WinCamD software on the PC.
- c) Start with the diode laser. Position the laser output aperture and WinCam CCD camera detector so they are separated at least 750 mm. Direct the laser energy onto the camera detector neutral density (ND) filter. If you are using the beam splitter as described in Attachment 1, position the beam splitter output face and WinCam camera detector at least 750 mm apart.
- d) Remove the dust cap from the camera, but make sure not to remove the ND filter that protects the CCD detector.
- e) In the WinCamD software, left click on the “G” icon. This begins data collection for beam profiling. If the camera is correctly positioned, a beam profile will begin forming on the monitor of the PC.
- f) Position the camera detector to center the profile being generated.
- g) When it appears that the beam profile is no longer significantly changing, left click on the “S” icon. This stops data from being taken and leaves the existing profile on the PC.
- h) Left click in the “Clip (a)” window of the display to initiate the “Clip level entry” window.
- i) Enter the distance between the source (laser aperture) and the camera detector into the “Source to imager distance in mm” data box in the “Clip level entry” window.
- j) Enable the angular divergence by left clicking the “Enable Angular Divergence” box. Make sure that the “Full angle in milliradians” box is selected.
- k) Answer “Yes” to any questions regarding measurement of angular divergence.
- l) Left click “OK” in the “Clip level entry” window.
- m) The angular divergence will be displayed in the “2Wua@13.5%” & “2Wva@13.5%” windows. Record the highest reading of the two for each type of laser.
- I. Diode laser beam divergence = _____
- II. HeNe laser beam divergence = _____
- n) Compare the obtained beam divergence measurements with the manufacturer’s specification. Are they within specification?
- I. Diode laser _____ Yes/No_____

- II. HeNe laser _____ Yes/No _____
- o) Record the ellipticity of the two different laser beams.
- I. Diode laser beam ellipticity = _____
- II. HeNe laser beam ellipticity = _____
- p) Describe and record the shapes of the beams from each laser. Are they “Gaussian” shaped?
- q) Click and drag in the 3D box to change the view of the 3D image.
- r) Once the desired beam profile has been captured and is ready to print, press “Print Screen” on the PC keyboard to capture the screen of the WinCamD software to the PC clipboard. Open a Word file, and press “Ctrl V” to transfer the clipboard data to the Word file. Use a thumb drive to transfer the file to a PC from which the file can be printed. Print the file, and attach it to the lab report.
- s) Repeat steps 10 b– r for the HeNe laser.
11. Compare the beam profiles of the diode and HeNe lasers. Comment on the differences and similarities.
12. Typically, a HeNe laser will have much higher beam quality than a diode laser. Given this fact, what reasons would you list for using a diode laser instead of a HeNe laser?

Attachment I

Testing Input Power to the Beam Profiler

During the lab, you will use the DataRay WinCamD laser beam imager. When using the WinCamD, it is extremely important not to exceed the maximum power input of the unit. Exceeding the maximum power of the unit could damage the neutral density (ND) filter or CCD detector. Use the following steps to determine whether the laser beam power exceeds the maximum input power of the WinCamD unit:

1. Measure the power out of the laser under test.
2. Measure the beam diameter of the laser under test. Multiply this diameter by 13.5% to find the adjusted beam diameter.
3. Refer to beam imagers “Saturation Beam Power / Pulse Energy Graphs” and determine the maximum permissible power for the wavelength being measured. The lines on the graph (in order from top to bottom: 400 nm, 500 nm, 1064 nm, 675 nm, 800 nm) represent the maximum power permissible for a particular wavelength.

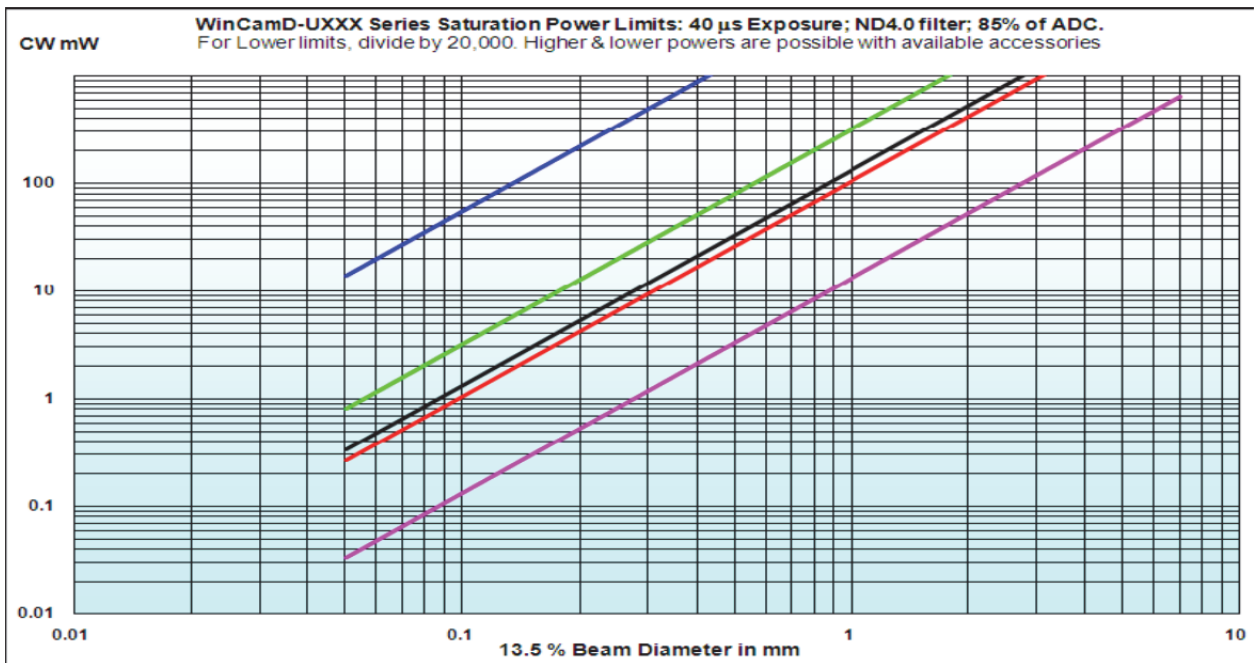

4. Locate on the horizontal axis of the graph the adjusted beam diameter, calculated in step 2 of this attachment.
5. Move vertically up the graph to the wavelength being measured.
6. At the intersection of the wavelength being measured and the adjusted beam diameter of the laser, use the vertical main axis to determine the maximum power permissible at that wavelength and adjusted beam diameter. (**Note: the vertical scale is in milliwatts, NOT watts!**)
7. In step 1 of this attachment, you measured the power. In step 6 of the attachment, you determined the maximum power permissible at the operating wavelength of the laser and calculated adjusted beam diameter. If the power measured in step 1 is *less than* the maximum power permissible at this wavelength and adjusted beam diameter, then proceed with step 10b of the laboratory. If the power measured in step 1 *exceeds* the maximum power permissible at this wavelength and adjusted beam diameter, then you must attenuate the laser's output power to a level that is under the maximum power permissible. Use the CUB beam splitter to attenuate the output power of the laser. The beam splitter has a 5% output. Calculate 5% of the power output of the laser that you measured in step 1 of the attachment, and if the calculated 5% is within the maximum permissible allowed into the laser beam profiler, then install the beam splitter into the path of the laser, with the output of the laser pointed into the input of the beam splitter. Then measure the power out of the 5% port of the beam splitter. If the power measured at the 5% beam splitter output is within the maximum permissible allowed into the laser beam profiler, proceed to step 10b of the laboratory. **If the output power of the laser cannot be attenuated below the maximum permissible allowed, the DataRay WinCamD laser beam imager CANNOT be used to profile the beam.**

WORKPLACE SCENARIO

Here is your opportunity to use the concepts you have learned in this module to solve an actual problem that could arise in a photonics company. Your instructor will provide directions for developing a solution.

Diode Pumping vs. Lamp Pumping

Scenario

Your company is discussing whether to switch from lamp pumping to diode pumping solid state lasers. You have been tasked with researching different aspects of using a diode laser to pump a Nd:YAG laser versus using a lamp as a pumping source for both a low-power and a high-power application.

Problem and Tasking

1. Determine the best laser-diode output wavelength to use as a pump source and explain your reasoning.
2. Summarize typical laser-diode power levels available for each application. Select a mid-level power from each application range, and provide a diode-laser manufacturer and part number for each application.
3. Describe the advantages and disadvantages of using a diode laser for a pump source versus a lamp as a pump source.
4. Based on these results:
 - a) Describe a low-power application that would benefit from using a Nd:YAG laser with a diode pump source versus a lamp pump source, and explain why. Define the:
 - I. Wavelength requirements of the pump source
 - II. Power range requirements of the pump source
 - III. Position of the pump source (side pumped versus end pumped)
 - IV. Optics required for the pump source
 - V. Cooling requirements of the pump source
 - b) Describe a high-power application that would benefit from using a Nd:YAG laser with a diode pump source versus a lamp pump source, and explain why. Define the:
 - I. Wavelength requirements of the pump source
 - II. Power range requirements of the pump source
 - III. Position of the pump source (side pumped versus end pumped)
 - IV. Optics required for the pump source
 - V. Cooling requirements of the pump source

Additional Information

You can find the information you need to solve this problem from at least three sources:

1. An explanation of the laser's output characteristics appears in *Module 2-6: Diode Lasers and Their Applications*.
2. Conduct an Internet search of "diode laser tutorials."
3. Conduct an Internet search of diode laser manufacture sites with application notes.

PROBLEMS EXERCISES AND QUESTIONS

1. Draw an energy-level diagram for a typical semiconductor diode.
2. Describe the mechanisms of current flow through the p-region, n-region, and junction region of a diode.
3. Describe the process by which laser diodes produce light.
4. Draw and label a diagram of a simple GaAs laser.
5. Explain two primary loss mechanisms in semiconductor lasers.
6. Explain how laser wavelength and threshold current vary with operating temperature.
7. Describe the spectral output of a semiconductor laser.
8. Describe the beam divergence of a laser diode. What produces this divergence?
9. Define what is meant by ternary and quaternary semiconductor lasers, and give one example of each type.
10. Describe vertical cavity surface emitting lasers.
11. Discuss short-wavelength semiconductor lasers.
12. Discuss mounting and cooling of semiconducting lasers.
13. Name applications of semiconductor lasers, including telecommunications and pumping of other types of lasers.
14. List five advantages of semiconductor lasers as compared with other lasers.
15. Describe five processes that produce damage in laser diodes and explain how to counteract them.

REFERENCES

- Agrawal, G. P., and Dutta, N. K. 1993. *Semiconductor Lasers*. 2nd ed. New York: Van Nostrand Reinhold.
- JDSU. 2008. Semiconductor Lasers: An Overview of Commercial Devices. *The Photonics Handbook 2008*. Pittsfield, MA: Laurin Publishing.
- Li, Herbert and Iga, K., eds. 2002. *Vertical-Cavity Surface-Emitting Laser Devices*. New York: Springer.
- Michalzik, Rainer, ed. 2012. *VCSELS: Fundamentals, Technology and Applications of Vertical-Cavity Surface-Emitting Lasers*. New York: Springer.
- Numai, Takahari. 2004. *Fundamentals of Semiconductor Lasers*. New York: Springer-Verlag.
- Overton, Gail. 2013. VCSEL Illumination. *Laser Focus World*. Nashua, NH: PennWell Corp. August.
- Pflueger, Silke. 2014. A High-power diode laser primer. In *Industrial Laser Solutions for Manufacturing*. Nashua, NH, PennWell Corp. January/February.
- Ready, John F. 1997. Practical Lasers. Chapter 3 in *Industrial Applications of Lasers*. San Diego, CA: Academic Press.
- Roff Robert, et. al. 2013. High-Power Laser Diode Modules Pump Disk Lasers. *Laser Focus World*. Nashua, NH: PennWell Corp. December.

INDEX OF TERMS

A

Advantages, 22-23, 26, 28
Applications, 23-32
 Optical telecommunications, 23
 Optical data storage and retrieval, 25
 Diode-pumped solid state (DPSS) lasers, 28
 Fiber lasers, 30
 Helium-Neon (HeNe) laser replacement, 31
 Materials processing, 31
 Medical and dental applications, 32

C

Catastrophic optical damage (COD), 21
Critical angle, 23

D

Damage to lasers, 21
Distributed feedback structures, 18

E

Edge emitters, 19

F

Frequency doubling, 29

L

Limiting damage, 22

M

Microchip laser, 29

S

Safety considerations, 33
Semiconductor (diode) laser, 1
Short-wavelength semiconductor lasers, 20

T

Threshold current, 6
Troubleshooting, 35

V

Vertical cavity surface emitting lasers (VCSELs), 19

Argon-Ion Lasers and Their Applications

Module 2-7

of

Course 2, *Laser Systems and Applications*
2nd Edition

OPTICS AND PHOTONICS SERIES



OP-TEC

National Center for Optics and Photonics Education



© 2016 University of Central Florida

This material was developed by the National Center for Optics and Photonics Education, OP-TEC, and is based upon work supported by the National Science Foundation under Grant No. 1144377 and completed under Grant No. 1303732. Any opinions, findings, and conclusions or recommendations expressed in this material are those of the author(s) and do not necessarily reflect the views of the National Science Foundation.

For more information about the text or OP-TEC, contact:

Dan Hull

PI, Executive Director, OP-TEC

316 Kelly Drive

Waco, TX 76710

(254) 751-9000

hull@op-tec.org

Published and distributed by

OP-TEC

316 Kelly Drive

Waco, TX 76710

254-751-9000

<http://www.op-tec.org/>

ISBN 978-0-9983480-6-3

CONTENTS OF MODULE 2-7

Introduction	1
Prerequisites	1
Objectives	2
Basic Concepts	2
Energy Transitions in Ion Lasers	2
Argon-Ion Energy-Level Diagram	3
Ion Laser Plasma Tube Design.....	6
Electrode Design	7
Other Tube Features	7
Operating Parameters of Ion Lasers	8
Dependence of Laser Output on Tube Current	8
Dependence of Laser Output on Gas Pressure	10
Dependence of Output Power on Magnetic Field Strength.....	11
Longitudinal Modes in Argon-Ion Lasers	11
Optical Cavities of Ion Lasers.....	13
General Characteristics of Argon-Ion Lasers.....	14
Resonator Frame.....	14
Electrical Systems	15
Power Supply	15
Interlock Systems	15
Auxiliary Circuits.....	15
Cooling System	16
Optical System	16
Frequency Doubling.....	16
Applications of Argon-Ion lasers	17
Summary	18
Safety Considerations.....	19
Troubleshooting	21
Laboratory	22
Workplace Scenario	28
Problems Exercises and Questions.....	29
References	30
Index of Terms	31

Module 2-7

Argon-Ion Laser Systems

INTRODUCTION

This module discusses the energy-transfer mechanisms responsible for lasing in argon-ion lasers and how these mechanisms affect ion lasers' design, construction, and output characteristics. Topics presented include ion laser energy-level diagrams, plasma tube design, auxiliary equipment requirements, and output characteristics. We use argon-ion lasers as the primary example of ion lasers because of their great importance and popularity.

The module includes descriptions of various subsystems present in argon-ion lasers. These include the resonator frame structure, electrical systems, interlock and safety systems, gas and water systems, and the optical cavity. The module also presents methods for changing the wavelength of an argon-ion laser and methods of enabling the argon-ion laser to function in a single longitudinal mode. Finally, we examine the desirability of single-mode operation and its effects on laser output.

In the laboratory, the student will operate an argon-ion laser and measure its output characteristics.

PREREQUISITES

OP-TEC's *Fundamentals of Light and Lasers Course*

OP-TEC's *Laser Systems and Applications Course, Module 1: Laser Q-Switching, Mode Locking, and Frequency Doubling, Module 2: Laser Output Characteristics and Module 3: Laser Types and Their Applications*

Understanding of high school level trigonometry and algebra concepts, including exponentials and logarithms

OBJECTIVES

Upon completion of this module, the student should be able to:

- Draw and label an energy-level diagram showing the important energy levels and transitions in an argon-ion laser and state the two strongest output wavelengths for an argon-ion laser.
- Explain the process by which an argon atom is excited from the atomic ground state to the upper lasing level.
- Explain two types of competition between pairs of lines in the argon-ion laser output spectrum. Give an example of each type of competition, and describe how this affects the multi-line output of the laser.
- Explain the de-excitation process that lowers the population of the lower lasing levels in the argon-ion laser.
- List and explain four critical factors that must be considered in ion laser tube design.
- Draw and label a diagram of a segmented laser tube.
- Explain how the output power of an argon-ion laser depends on each of the following parameters:
 - Tube current
 - Gas pressure
 - Magnetic field strength
- Use a diagram to explain how various wavelengths are selected for single-line operation in an argon-ion laser.
- Determine the mode spacing of the laser output and the approximate number of modes oscillating.
- Use materials and procedures listed in this module to operate an argon-ion laser and measure its output characteristics.

BASIC CONCEPTS

Energy Transitions in Ion Lasers

This module describes the argon-ion laser, which emits light in the blue and green portions of the visible spectrum. As its name implies, the active material for this laser is argon ions. Ions used in ion lasers are atoms from which one or more electrons have been removed to produce an ion with a net positive charge. Such an atom is ionized by adding enough energy to free one of its electrons. This energy may be added in a single collision that liberates the electron from the atom, or it may be added incrementally, increasing the energy state of the atom in small steps until the ionization energy is reached and an electron is liberated. The minimum energy of an

atom with one electron missing is called the *singly ionized ground state*. An ion's energy levels have structures similar to those of neutral atoms. If enough energy is added to the ion, it will lose a second electron and become *doubly ionized*, and so forth. Ion lasers are gas lasers in which the stimulated emission process occurs between two energy states of an ion. The excitation mechanism of such a laser must first supply the necessary energy to remove an electron from the lasing atom to produce the ion, and then supply additional energy to raise the ion to the appropriate excited state. These large input-energy requirements result in low efficiencies for essentially all ion lasers. An example of this can be seen in Figure 7-1.

Two types of ion lasers are in common use. One type uses helium as a buffer gas for achieving lasing of ionic metal vapors. The most common laser of this type is the helium-cadmium laser, which produces a few milliwatts of power at laser output wavelengths of 441.6 nm and 325 nm. Several other metals may be used in similar systems. This type is referred to as a *metal vapor ion laser*. These are typically low-current, high-voltage devices similar in many ways to HeNe lasers, although they are more complex because they require close temperature and current control. Although these metal vapor ion lasers do fall into the category of ion lasers, we do not discuss them further in this module.

The more important class of ion lasers is the one employing noble gases as the lasing medium. Argon-ion lasers are by far the most numerous and important of this group, but krypton-ion lasers are also in use. Xenon-ion lasers are also available, but they are much less common.

Noble gas-ion lasers typically produce lasing between two states in the singly ionized atom. To place the ion in the proper state, the excitation mechanism must provide sufficient energy to first ionize the atom and then raise the ion to the proper excited energy state. This module discusses how this is accomplished.

Argon-Ion Energy-Level Diagram

The energy-level diagram in Figure 7-1 shows the most important energy levels and transitions involved in the operation of an argon-ion laser. The principal lasing transitions are labeled with their wavelengths in micrometers (μm). Note that the energy axis has a break in it; the energy to ionize the atom is much larger than the energy required to move it to the excited state. As Figure 7-1 indicates, it requires more than 17 eV to remove one of the electrons from the ground state of the argon atom and produce an argon ion. A great many other energy states and transitions are possible for argon ions; the figure shows only those that are important for lasing. The energy-level diagram of krypton-ion lasers is similar, and the processes described below also apply to krypton lasers.

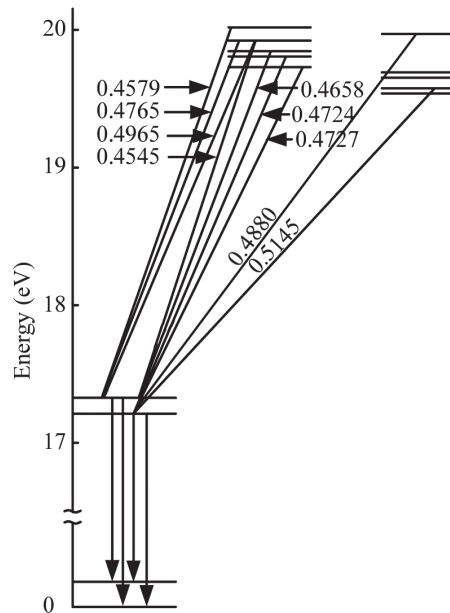

Figure 7-1 Energy-level diagram of a singly ionized argon ion (The diagram shows only those energy states and transitions relevant to operation of the argon-ion laser.)

Excitation in Ion Lasers

Excitation of atoms from the atomic ground state of argon to a metastable (upper lasing) level of the ion requires many electron volts of input energy to the atom. This energy is delivered in the form of electron collisions. Each electron collision imparts 2 to 4 eV to the atom, which move it from one atomic energy state up to a higher state. Because these atomic states have short lifetimes, the atom must experience a collision quickly after each upward transition; otherwise, it will emit a photon and drop back toward the ground state. Thus, a high current density is necessary to provide the required collision rates, and increasing current density in the bore of the laser tube increases the output power.

The accumulated energy of successive electron collisions eventually removes an electron from the atom raising the resulting ion to one of the energy levels between 17 and 18 eV (see Figure 7-1). Then, after more collisions, the ion is raised to a metastable energy state (shown between 19 and 20 eV in Figure 7-1) that supports the production of laser light. The ions in these metastable energy levels produce the population inversion necessary for lasing. Ions in energy states above the metastable states quickly drop to one of the metastable states by releasing one or more photons. These ions further add to the population inversion and increase the output of the laser.

Lasing Action in Ion Lasers

The gain for any one of the possible laser lines in an ion laser depends upon the population inversion between the upper and lower lasing levels for that line. Lines with the greatest population inversions have the greatest gain and, therefore, the highest output power. From nine to twelve lines may lase in a typical argon-ion laser. Table 7-1 lists the strongest lasing lines for both argon and krypton and also gives the power at each wavelength for a typical argon- or krypton-ion laser—one that does not have wavelength selection and thus emits many different wavelengths simultaneously.

Table 7-1. Representative Ion Laser Output

Nominal 20 W multi-line argon-ion laser		Nominal 14 W multi-line krypton-ion laser	
Wavelength (nm)	Power (W)	Wavelength (nm)	Power (W)
528.7	1.4	676.4	0.9
514.5	8.5	674.1	3.5
501.7 ^(a)	1.4	568.2	1.1
496.5	2.4	530.9	1.5
488.0	6.5	520.8	0.7
476.5	2.4	482.5	0.4
472.7	1.0	476.2	0.4
465.8	0.6	468.0	0.5
457.9	1.4	415.4	0.3
454.5	0.6	413.1	1.8
333.6–363.8 ^(b)	4.0	406.7	0.9
		337.5–356.4 ^(b)	2.0

(a) Not shown in Figure 7-1 (b) With special mirrors

A dispersing or tuning prism may be used inside the cavity to allow only one selected line to operate at a time. This will be described in detail later.

If the tuning prism is omitted and laser mirrors are aligned to allow lasing at any wavelength in the overall gain region, several lines will produce laser output at once. In argon-ion lasers, the five strongest lines usually will lase at once, although in lower-power models, one or two of these may be missing. The other lines will not lase, because they are in competition with stronger lines.

The greatest population inversion and output power occur for the 488 nm and 514.5 nm lines. These lines result from argon ions in different metastable states (upper laser levels) dropping to the same lower laser level. When either or both of these lines produce laser output, they drop argon ions into the lower lasing level, significantly increasing that level's population. As the population of this lower lasing level increases, it eventually exceeds the population of ions in the metastable states (upper lasing levels) that are not involved in the generation of the two strong lines at 488 nm and 514.5 nm. When this occurs, a population inversion no longer exists between these other metastable states and the lower lasing level for the 488 nm and 514.5 nm lines. This means that lasing will not occur from these other metastable states and their lines will not appear in the laser output. The only way these weaker lines appear in the laser output is when the stronger lines are suppressed. The 488 nm and 514.5 nm lines compete in similar way. If one of these lines is suppressed, then the other line becomes stronger, indicating that the laser output contains a much larger component of the wavelength of light associated with that stronger line.

Figure 7-1 also illustrates the competition between the 476.5 nm line and the 454.5 nm line. These two lines have the same upper lasing level but different lower levels. Thus, they are in competition for the same excited ions, and the one that lases will be the one with the lowest population in the lower lasing level. But as we've discussed, the lower lasing level of the 454.5 nm line is also shared with the 488 nm and 514.5 nm lines, and these two strong lines quickly add argon ions to the 454.5 nm lower laser level, increasing its population. Thus, unless the 476.5 nm line is suppressed, the 454.5 nm line will not lase.

The energy levels of krypton-ion lasers work similarly, and these lasers also may be operated either on one line at a time or on several lines at once. A unique feature of krypton lasers is that, with the proper mirrors, they will lase simultaneously on four lines that are red, yellow, green, and blue, producing an output beam that appears white. This white beam is uniquely suited to laser light shows and laser imaging systems and may potentially be suited to laser television. Also, a laser with mixed argon and krypton can operate on the strong green and blue lines of argon and the red lines of krypton. This also can be used for full-color displays and shows.

De-Excitation in Ion Lasers

When lasing has occurred, the ions drop from the lower lasing level to the ionic ground state by emitting a photon with a wavelength of about 70 nm. This transition occurs very rapidly causing a low population in the lower lasing levels. The 70 nm wavelength is very deep in the ultraviolet range and is absorbed by the laser tube.

Electron collisions may excite the ion directly from the ionic ground state back to the upper lasing levels, but more often, the ion captures an electron and drops further in energy before being re-excited—although it may not drop all the way to the neutral-atom ground state. At any given moment during laser operation, only a small percentage of the argon atoms are ionized.

All waste energy from the laser discharge is absorbed into the laser tube structure. As the efficiency of a typical argon-ion laser is only about 0.05%, a 5 W laser produces 10 kW of waste heat in the laser tube. The limitation on the output power of the laser is dependent on how efficiently heat can be removed. An increase in internal temperature does not degrade the lasing process as in solid state and molecular gas lasers, but at some point, the laser components degrade by overheating.

Ion Laser Plasma Tube Design

Ion laser tubes must withstand high currents and high internal temperatures. Several materials and designs have been successfully used to construct these tubes. The following are general considerations for ion laser tube construction:

1. The tube must withstand thermal loads on the order of 500 W per centimeter of length. This heat is largely produced by ion bombardment. High-energy ions will erode most bore materials rapidly.
2. Positive ions are attracted to the cathode, resulting in unequal gas pressures along the bore. This greatly reduces laser power and may stop lasing completely. Gas bypass channels must be provided to equalize the pressure for proper performance.
3. Electrodes must be designed to withstand the discharge current (typically 50 to 200 A), and the cathode, in particular, must be resistant to ion bombardment.
4. Gas pressure is continuously reduced by ions embedded in the inner surface of the tube. A provision for adding gas is required in most ion lasers.

Early ion lasers used tubes with water-cooled quartz bores. These were unacceptable because ion bombardment quickly eroded the bore, reducing laser efficiency and destroying the laser tube in a hundred or so hours of operation. Extensive research led to development of a segmented design for ion laser tubes that is used in all argon- and krypton-ion lasers today.

The most common design used in recent times is that of a segmented bore, shown in Figure 7-2. It allows for more effective cooling because of the larger area for radiative cooling. Copper heat webs may be used between the bore segments. The segments are annular rings whose thickness is less than one centimeter. The beam path internal to the laser is defined by a hole in the center of the segments. Return channels for the gas can be provided by holes in the segments farther out from the center.

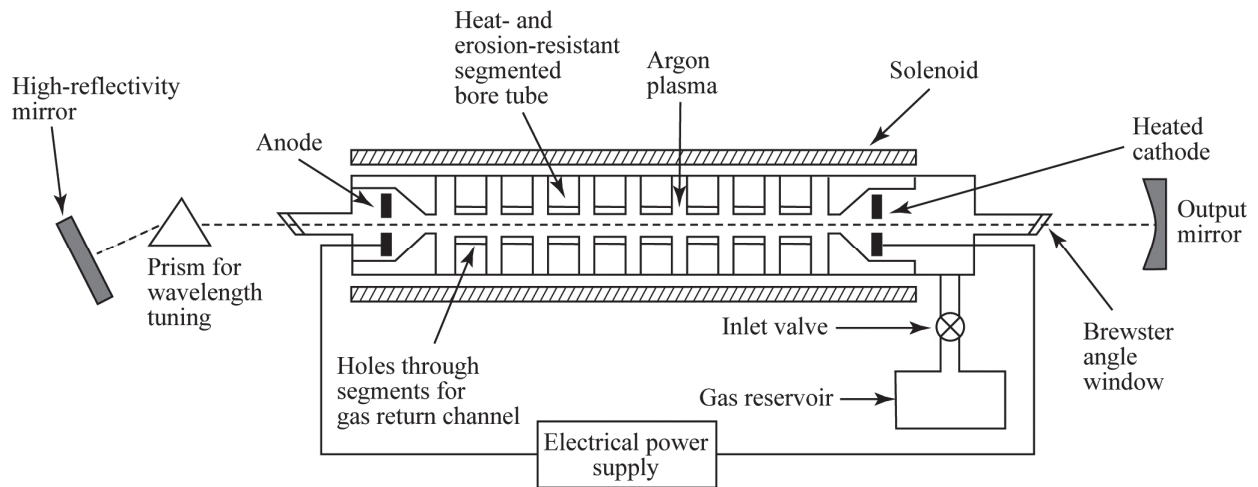

Figure 7-2 Typical argon-ion laser structure with segmented bore

A variety of materials have been used for the segments of the bore of the plasma tube. These include graphite, beryllium oxide, and tungsten. These materials can withstand the high temperatures and ion bombardment associated with ion lasers. Commercial lasers using graphite and beryllium oxide were manufactured for many years, and some are still in use. More recently, metal-ceramic tubes with tungsten segments and an alumina-ceramic envelope have become the most common type. This design has substantially increased the lifetime of argon-ion lasers. Manufacturers quote lifetimes in excess of 5000 hours for metal-ceramic tubes.

Higher-power argon-ion lasers (with outputs of several watts or more) are generally water cooled, with a heat exchanger to dissipate the heat generated. Lower-power argon-ion lasers (with outputs of hundreds of milliwatts) may be air cooled.

Ion laser tubes are generally not serviceable by a technician. When a tube fails, it is usually replaced by a new tube from the manufacturer.

Electrode Design

The anode of the laser tube is subjected to bombardment by electrons from the tube current. Because the electrons have very little mass and, thus, low kinetic energy, they do not cause significant heating of the anode. The anode may be a metal ring inside the quartz envelope.

The cathode is a coiled tungsten ribbon coaxial to the optical axis. A filament transformer provides a current through the cathode that heats it to an orange glow and produces a cloud of thermally-emitted electrons. Positive ions attracted to the cathode interact with this electron cloud, capture an electron, and become neutral atoms. By losing their net charge, the argon atoms are no longer attracted to the negative cathode and gain no more kinetic energy. The remaining kinetic energy of these neutralized ions is then dissipated by collisions with other atoms in the gas before reaching the cathode. If the electron cloud is not present, the high-speed positive ions gain kinetic energy as they approach the cathode, strike it, and quickly destroy it.

Other Tube Features

Ion laser tubes typically incorporate several other design features to ensure proper operation. An increase in temperature of the gas in the small active volume results in large pressure changes

that reduce laser output. This is prevented by connecting the tube bore to a large-volume ballast at a lower temperature. When heated, gas from the bore expands into this volume, its pressure changes very little, since a lower temperature and greater volume work to reduce pressure. Most tubes are also equipped with valves that are used to add a measured amount of gas to the laser tube as necessary to maintain proper operating pressure. A thermocouple vacuum gage to measure tube pressure is usually included.

The plasma tube is surrounded by a *solenoid* that produces a uniform magnetic field along the optical axis in the bore of the tube. Charged particles moving along the lines of magnetic force are unaffected. Those moving at an angle to these lines are forced into a spiral path around the magnetic field lines. This serves two purposes. First, ions that are headed away from the center of the tube are bent back toward it, thus increasing current density and reducing ion bombardment on the bore walls. This reduces erosion and heat load. Second, the spiral path means that electrons have longer path lengths in moving from one end of the tube to the other and, thus, are likely to have more collisions than if they took a straight path.

Operating Parameters of Ion Lasers

Ion lasers may be operated either with several laser lines in operation or with only one. In either case, output power depends on tube current, gas pressure, and magnetic field strength. This section discusses how these parameters affect laser output power.

Dependence of Laser Output on Tube Current

The most general expression for the output power of an argon-ion laser indicates that the power increases approximately with the square of the current density. (Current density is the current in amperes divided by the area of the tube bore in square centimeters.) One consequence of this relationship is that smaller bores produce higher powers for the same current values. Thus, ion lasers are constructed to have the smallest bore diameters possible without introducing excessive diffraction loss or erosion.

For a specific argon-ion laser, output power varies roughly with the square of the tube current near the high-power end of its output range. Thus, doubling the current would produce four times the output power. At lower power levels, output power typically increases even more steeply. Figure 7-3 shows output power versus current curves for an argon-ion laser in multi-line operation at several gas pressures. The slope of the power versus current curve varies somewhat with pressure, but in all cases, a small current increase produces a significant output power increase. Thus, ion lasers are designed to operate at the highest possible currents that the tube can withstand for its rated lifetime.

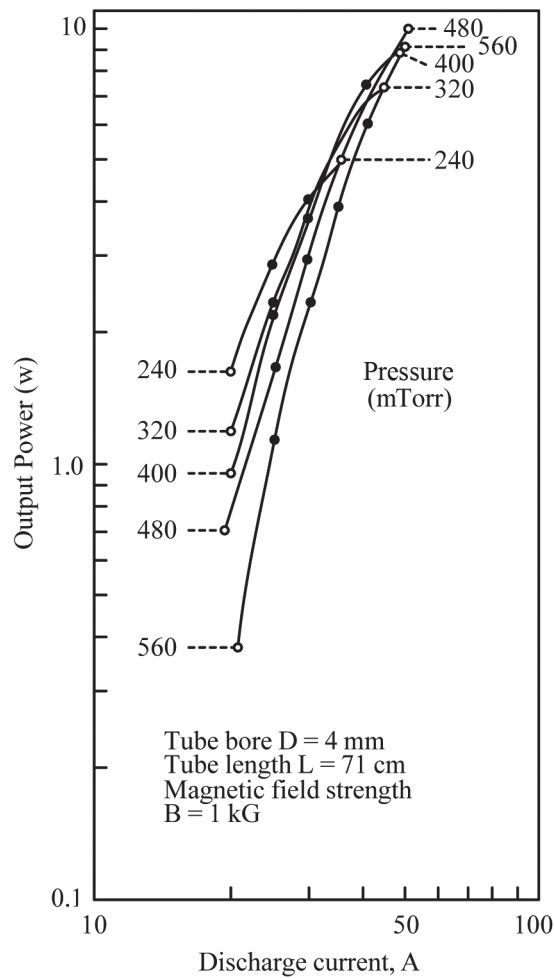

Figure 7-3 Output power versus current for an argon-ion laser with all lines operating at various operating pressures

Figure 7-4 shows output powers of several ion laser lines as functions of tube current when a prism wavelength selector is used inside the laser cavity. A specific wavelength may be selected by rotating a prism inserted in the laser cavity, as shown in Figure 7-2. Figure 7-4 shows that the 514.5 nm and 488 nm lines have the highest power levels of all the output lines; units are shown in angstroms (\AA), and one angstrom is equivalent to 0.1 nm.

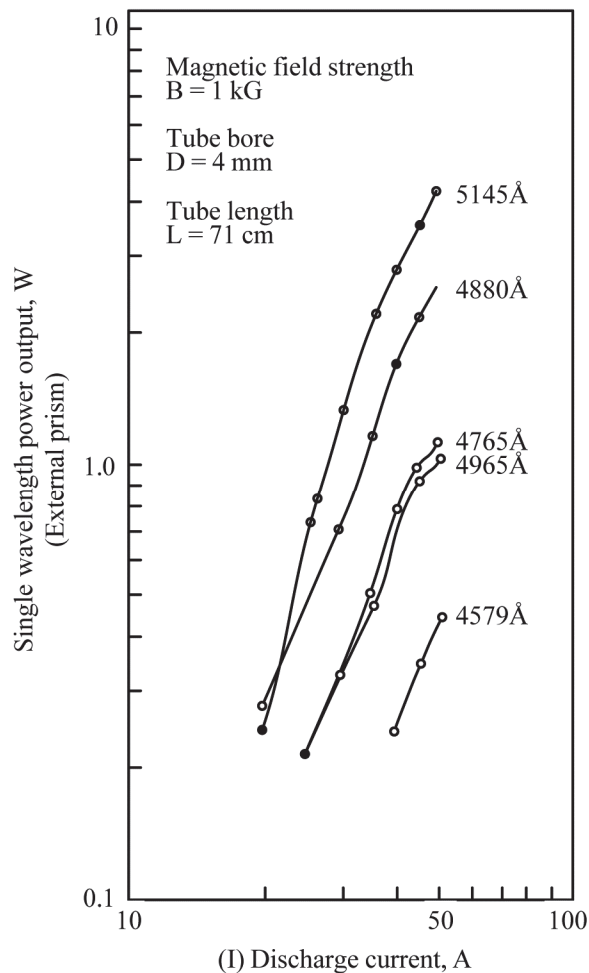

Figure 7-4 Spectral distribution of the blue-green output lines in the Ar^+ laser

Dependence of Laser Output on Gas Pressure

Argon and krypton lasers may be operated at gas pressures from 250 to 500 mTorr, but the best operation is usually in the range of 300 to 350 mTorr. Specific systems are designed to operate best at a specific gas pressure, and the laser power supply is matched to tube characteristics at that pressure. Changes in tube pressure result in variations in output. Gas pressure drops as gas is absorbed inside the tube, and additional gas is required periodically. If gas pressure is too low or too high, electrical characteristics of the tube may become incompatible with the power supply, resulting in failure of the tube to start-up or operate in a stable manner. Older argon-ion lasers have gas reservoirs that may be operated with a fill valve, as Figure 7-2 indicates.

Gas pressure in an ion laser typically increases after the laser reaches operating temperature. The increase may continue for several hours if the laser has been out of operation for a long time. A common mistake in operating an infrequently used ion laser is to initially add gas to bring the pressure up to the specified operating point at turn-on. This usually results in serious overpressure after a few hours of operation. Then, the only way to lower the pressure is to run the laser for an extended time or, in extreme cases, to reprocess the tube. Thus, if the laser has not been used for a prolonged period, gas should not be added too hastily even when the pressure reading is low.

Modern ion lasers have automatic pressure monitoring and refill capabilities. But older lasers, in which the operator opens a valve to replenish the gas, are still in use. The operator of such a manually adjusted gas-fill system should observe the precautions described earlier.

Dependence of Output Power on Magnetic Field Strength

Figure 7-5 shows variations in output power of an argon-ion laser at the two strongest laser lines as magnetic field strength is varied. If there is no field, current density in the center of the bore is reduced, and more energy is lost through collisions with the tube's walls. An increase of magnetic field strength increases current density and output power.

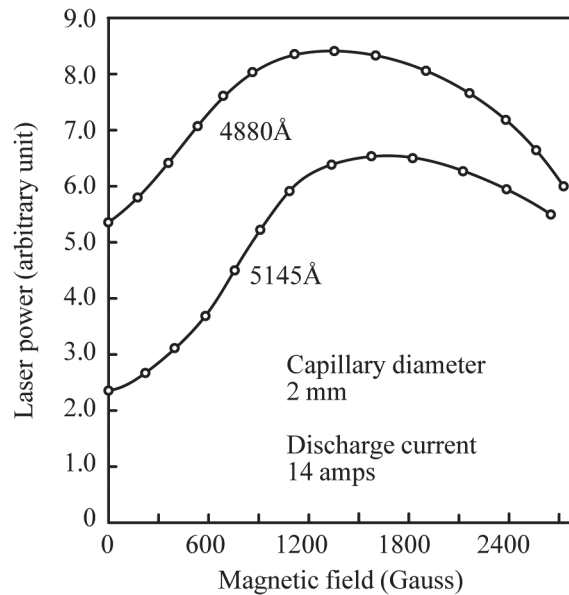

Figure 7-5 Laser output power in argon-ion laser versus magnetic field strength

When a gas is subjected to a strong magnetic field, each of its energy levels splits into several closely spaced levels. This is called *the Zeeman effect*. The degree to which these lines are split is proportional to the strength of the magnetic field. The magnetic field in an argon-ion laser broadens the laser gain curve proportionally to the strength of the magnetic field. Field strengths below about one kilogauss produce a broadened output spectrum with more cavity modes and higher output power. Above about one kilogauss, the gain curve becomes so broadened and flat that its edges fall below the lasing threshold, and the output power and spectral lines both begin to drop. Each laser line has an optimum magnetic field strength. Most argon-ion lasers have a control to adjust the magnetic field strength for optimum operation on each line.

Longitudinal Modes in Argon-Ion Lasers

Figure 7-6 shows the longitudinal mode structure of a laser. Lasing will occur for any mode for which the gain is above the threshold line. Frequency spacing between two adjacent modes is given by Equation 7-1.

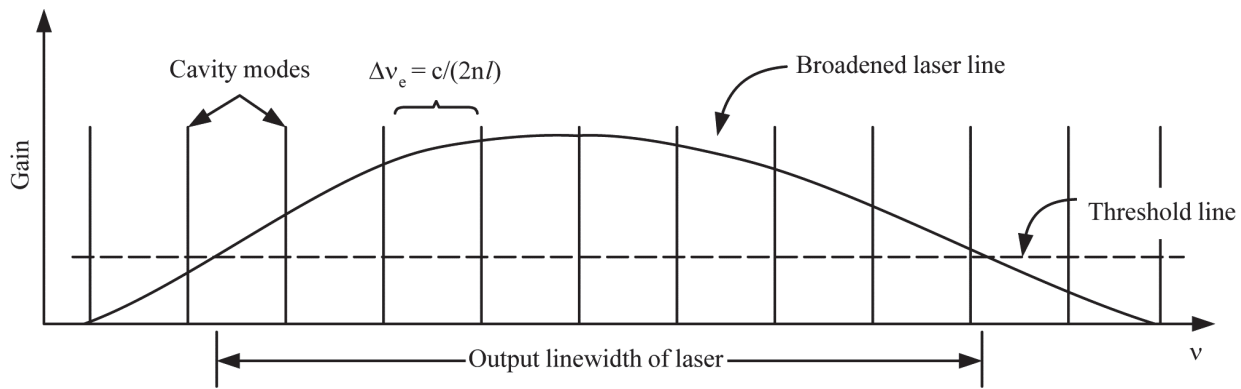

Figure 7-6 Longitudinal modes in a laser

$$\Delta\nu_e = c/2nl \quad (7-1)$$

where: $\Delta\nu_e$ = Mode spacing of laser cavity, in Hz
 c = Speed of light
 n = Index of refraction of cavity medium
 l = Cavity length

Example 1 illustrates the use of this equation in determining mode spacing of an argon-ion laser.

Example 1

Mode Spacing of an Argon-Ion Laser

Given: An argon-ion laser has a cavity length of 1.25 m.

Find: Longitudinal mode spacing.

Solution:

$$\begin{aligned} \Delta\nu_e &= c/2nl \\ &= \frac{(3 \times 10^8 \text{ m/s})}{(2)(1)(1.25 \text{ m})} \quad (\text{assume } n = 1.0 \text{ for gas laser}) \\ &= 1.2 \times 10^8 / \text{s} \\ \Delta\nu_e &= 120 \text{ MHz} \end{aligned}$$

The number of longitudinal modes present in the laser output is approximately equal to the total laser linewidth divided by the mode spacing. In an argon-ion laser, linewidth depends upon which line is lasing, the current, and the magnetic field strength. Linewidth for the 488 nm line is typically around 8 GHz. If the laser in Example 1 has this linewidth, there will be approximately 67 modes in its output. Ion lasers typically have broad laser linewidths because of the Doppler effect in the high-temperature laser gas.

In many uses, this is not a desirable quality. Many spectrograph applications require narrow linewidths and stable wavelength operation or control. Applications involving interference of light often require long coherence lengths. A narrower linewidth results in a greater coherence length. It is possible to install optical devices in the laser cavity that will reduce the number of longitudinal modes to a single mode. This reduces the linewidth substantially.

Optical Cavities of Ion Lasers

Most ion lasers employ long-radius hemispherical optical cavities. A typical 5 W argon-ion laser has a cavity length of about 1.25 m. The high reflectivity (HR) mirror is flat, and the radius of curvature of the output coupler (OC) is four or five meters. This produces a small beam inside the bore of the laser tube while making optimum use of the active volume.

Figure 7-7 shows transmission curves for the mirrors of a typical argon-ion laser. The HR mirror has a broadband coating that is 99.9% reflective across the entire blue-green portion of the spectrum. The OC (output mirror in Figure 7-7) coating is designed for specific transmissions at specific laser wavelengths to provide the best operation for each laser line. Transmission typically varies from 1% to 4.5% in the spectral output range of the laser.

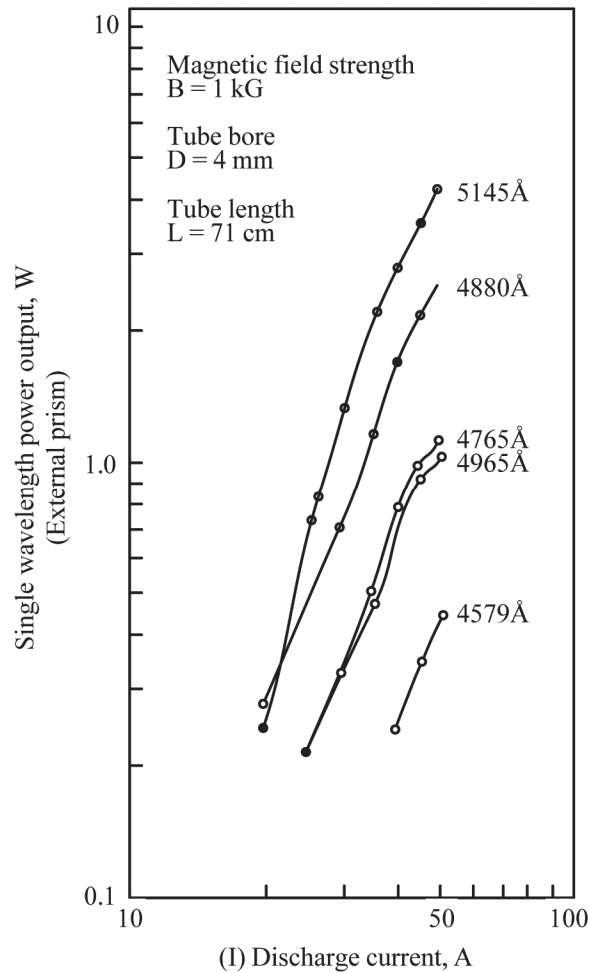

Figure 7-7 Broadband multilayer coatings for argon-ion laser cavity mirrors

We previously mentioned the use of a prism to select single-line operation. The tuning mechanism most commonly employed to select a single laser line is a prism inside the optical cavity, as shown in Figure 7-2 and in more detail in Figure 7-8. The prism is cut so that the laser beam strikes it near Brewster's angle on both sides. For a fused quartz prism, the apex angle is 78° . The prism and HR mirror are mounted rigidly together and are tilted as a unit to select various wavelengths. Because the prism refracts each wavelength by a different amount, only a single laser line is in proper alignment at any time.

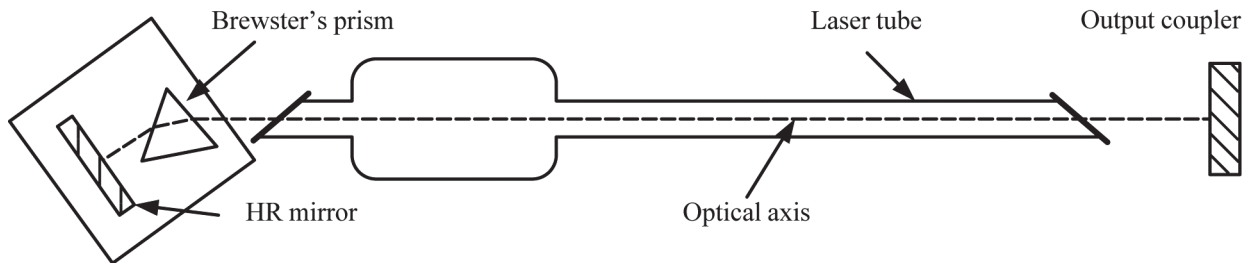

Figure 7-8 Argon laser with prism wavelength selector

General Characteristics of Argon-Ion Lasers

Argon-ion lasers are available in a range of sizes, from air-cooled models that produce milliwatts of output power at 488 nm and 514.5 nm to the largest commercial models with output of tens of watts multi-line. All but the smallest of these lasers incorporate the same features of design and control. The first part of this module described these lasers' general characteristics, the construction of ion-laser tubes, and the design of the basic optical cavity. The rest of this module describes the design and operating characteristics of other ion-laser subsystems.

Resonator Frame

The stability of any laser depends on the geometrical (angular and length) stability of the resonator frame that supports the optical components and laser tube. Stability is often a prime consideration in argon-ion laser applications. Argon-ion lasers require more careful design for high stability than most other systems. Large temperature gradients and fluctuations, vibrations from water flow, and magnetic effects associated with high-current operations all contribute to system instability.

The first factor to be considered is the laser cavity's angular stability. If the resonator frame is bent or flexed during laser operation, optical alignment will be affected, which in turn will reduce output power. Long-term stability can be greatly reduced if various parts of the resonator structure experience significantly different temperature changes.

Early argon-ion lasers had an aluminum frame for mounting the plasma tube and optical elements. More recently, argon laser frames have been made from a metal called *invar*. Invar is a nickel alloy with a very low thermal coefficient of expansion. The use of invar frames has led to a very high degree of stability for ion lasers.

Electrical Systems

Argon-ion lasers' electrical systems are more complex and sophisticated than those of most laser types. Argon-ion lasers require higher current and lower voltage than most other lasers require. A detailed discussion of these electrical systems is beyond the scope of this module. For detailed electrical schematics, refer to the user manuals for specific models of argon-ion lasers.

Power Supply

The power supply for argon-ion lasers is a high-current, low-voltage supply with an LC filter section and a transistor pass bank current regulator. Input power typically is either 208 V, three-phase, or 460 V, three-phase, depending on laser power. The regulated power supply provides a constant current for both the laser tube discharge and the solenoid. Tube discharge current is controlled by a front panel adjustment that sets the voltage on the bases of transistors in the pass bank and, thus, current flowing through the bank. In most models, a separate current regulator and control are used for magnet current.

Two other major components are necessary for supplying power to the argon-ion laser tube. A filament transformer provides a large current at low voltage to heat the cathode to the proper temperature. This current is preset and is not adjustable. A trigger transformer activated by a push-button switch provides a high-voltage pulse that initiates the laser discharge. The control circuitry includes a time delay that prevents application of the start pulse until the cathode has time to achieve proper operating temperature.

Interlock Systems

Argon-ion lasers have a series of interlock and safety features for protection of both equipment and operator. Interlocks on the covers of the power supply and the laser head automatically turn laser power off if covers are removed. An input terminal is usually provided to the interlock system to shut off laser power if some external circuit is broken. In many cases, this circuit is part of a room interlock system that turns the laser off if the door is opened during laser operation.

Other safety systems are designed primarily to protect laser equipment. These include sensors that turn the laser off if any of the following conditions exist:

1. The laser tube current exceeds a preset level.
2. One or more of the input phases is not receiving power.
3. The water-flow rate is too low.
4. The exhaust-water temperature is too high.
5. The power supply experiences an overvoltage current.

Auxiliary Circuits

A number of other electrical subsystems are included in most argon-ion lasers. These include power supplies necessary for operation of interlock circuits, the thermocouple gage, the gas fill system, and control and monitoring circuitry.

Most argon-ion lasers have a front panel meter that serves several measuring functions. These typically include tube current, output power, tube gas pressure, and power supply regulation range. Indicator lights often are used to indicate the conditions of several laser subsystems.

Cooling System

All but the smallest argon-ion lasers require water cooling. Argon-ion lasers with output in the milliwatts range can be air cooled. But argon-ion lasers with output above a few watts are all cooled with water at flow rates in the range of 2.2 to 7.0 gallons per minute, depending on laser power and size. The water-flow system normally includes an input filter to remove any contaminants. Water flows through the laser power supply pass bank and the laser tube. Sensors monitor flow rate and exhaust water temperature and turn the laser off if their limits are exceeded. The water-flow sensor is typically connected to the output water port of the laser system so that it will turn the system off if a large leak or disconnection occurs. If the switch is located on the water input, the system will continue to operate even if a hose is broken and no water reaches some components. The water flow switch should be checked periodically to ensure proper operation and flow setting. Another good practice is to drain all water from an argon-ion laser before storing or shipping it.

Optical System

Earlier in this module, we discussed the basic design of the optical cavity for argon-ion lasers, the characteristics of laser mirrors, and the operation of the prism wavelength selector. Several additional optical elements and subsystems are often included in argon-ion lasers.

One common additional element in the optical cavity is an adjustable aperture near the laser OC. This aperture is used to change the effective aperture of the laser cavity. With the aperture opened all the way, the limiting aperture is provided by the walls of the laser tube. In this condition, some of the laser lines, particularly those at shorter wavelengths, may oscillate in TEM modes other than TEM₀₀. This may be desirable to achieve the greatest output power. Closing the aperture partway will result in the TEM₀₀ mode of any laser line being selected, since higher-order modes will experience increasing diffraction losses.

Another common optical subsystem is a built-in optical power meter for monitoring laser output power. This consists of a beam splitter on the laser output aperture that reflects a small percentage of the laser output to a photocell that is connected through an amplifier to the front panel meter of the laser power supply. The meter is calibrated to indicate the laser's true output power. Many systems feature a light-regulation mode that uses this optical signal to control tube current and, thus, the laser's output power. This assures a constant output power even if some laser parameters change during operation.

Frequency Doubling

Frequency doubling can extend the wavelength range of argon-ion lasers. A method for producing this doubling is to insert a nonlinear optical crystal into the cavity. Certain crystals reduce the operating wavelength by half. In this way, argon-ion lasers have operated at a variety of wavelengths in the deep ultraviolet range, including wavelengths as short as 229 nm. A nonlinear optical material that is often used with argon-ion lasers is beta-barium borate.

Applications of Argon-Ion Lasers

Argon-ion lasers are used in applications that require laser beams with good coherence, very high beam quality, or single-mode operation. They compete with other CW green or blue lasers, especially frequency doubled diode-pumped Nd:YAG lasers, for use in various applications. Such Nd:YAG lasers may be smaller and less expensive than argon-ion lasers. The laser that is chosen depends on the requirements of the particular application.

Argon-ion lasers are widely used in medical applications, particularly those involving eye conditions such as glaucoma. Because of their precision in targeting a specific area, argon-ion lasers are used in ophthalmic surgeries, including surgeries to treat glaucoma and other diabetic eye disease. In dermatology they are used to treat ulcers, lesions, and polyps.

Table 7-2 summarizes some of the applications of argon-ion lasers. This is not a complete list, but it will give you an idea of how argon-ion lasers are used.

Table 7-2. Applications for Argon-Ion Lasers

Class of Application	Specific Application	Comments
Medical	Ophthalmic surgery	Usually to remove abnormal material
	Photodynamic Surgery	Used along with photosensitive drugs
	Glaucoma	Opens drainage paths for aqueous humor to relieve pressure
	Measurement of blood cells in a flow	
	Treatment of acne	
	Acupuncture	
Entertainment	Laser light shows	Uses both argon-ion and krypton-ion
Materials Processing	Curing resins for stereolithography (optical fabrication)	Uses ultraviolet lines
	Making fiber Bragg gratings	
	Semiconductor inspection	Detects defects
	Modifying thin films	For high temperature superconductors
Printing	Printing offset images	Uses an ultraviolet line
Spectroscopy	Raman spectroscopy	
Chemistry	Etching metal films	
Lasers	Optical pumping source	

If you require more information or greater detail on the applications presented in Table 7-2, go to the OP-TEC website, www.op-tec.org, and review the modules in the Photonics-Enabled Technologies (PET) series. These modules cover a broad range of photonics applications in the following technology areas: manufacturing, biomedicine, forensic science and homeland security, environmental monitoring, optoelectronics, data storage and imaging, fiber-optic communication, and holography. You may request a download copy of a PET module through the OP-TEC website.

Summary

The most common type of ion laser is the argon-ion laser, which operates in the blue-green region of the visible spectrum. The next most popular ion laser system is the krypton-ion laser, which has output lines across the entire visible spectrum. The two are similar in construction and performance, with the argon-ion system producing higher powers for longer lifetimes.

Efficiencies of ion lasers are low because of the large amount of input energy required to ionize atoms and excite them to the proper ionic state. Because power increases roughly with the square of the current density, ion lasers are designed with the smallest bore diameters and highest tube currents possible.

Argon-ion lasers are among the most complex systems in common use. Subsystems necessary for the operation of an argon-ion laser include the laser tube, a stable resonator frame, a sophisticated and versatile optical system, a gas-control system, a water-based cooling system, and an electrical system that includes the power supply and a wide range of monitoring and control circuitry. Argon-ion lasers may be constrained to operate on a single longitudinal mode to improve the beam's spectral purity and coherence.

SAFETY CONSIDERATIONS

When ion lasers are needed in industry or medicine, argon- and krypton-ion lasers are the most common choices. Argon-ion lasers commonly operate at wavelengths of 488 nm and 514nm, and krypton-ion lasers operate at wavelengths throughout the visible spectrum, so both are a threat to the retina of the eye. This threat is compounded because 514 nm is a green wavelength, and the eye is most sensitive to wavelengths in the green portion of the electromagnetic spectrum.

The retina of the eye contains photoreceptors that convert optical images to electrical signals that are sent to the brain. The fovea, positioned directly across from the lens of the eye, as shown in Figure 7-9, is the central part of the retina. The fovea is responsible for scanning, reading, and perception. Viewing intrabeam or specular reflection without eye protection could result in damage to the fovea and loss of eyesight.

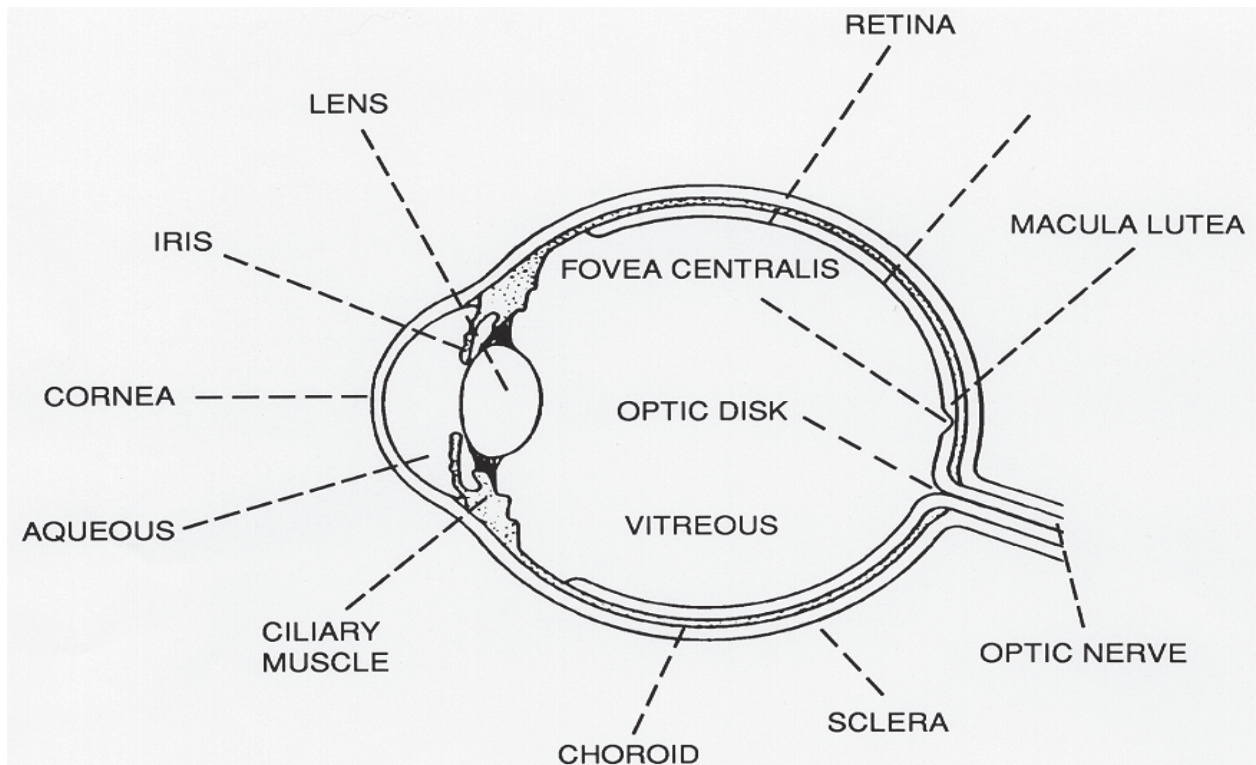

Figure 7-9 *Structure of the human eye*

The lens of the eye has a focal length of about 1.7 cm. A laser beam entering the eye will interact with this lens, significantly increasing the irradiance at the retina. The following example demonstrates this effect.

Example 2

A lab technician is accidentally exposed to a 1 mW laser beam. The irradiance focused on the cornea of the eye is 2.5mW/cm². The lens of the eye focuses a spot of 16 μm (16 x 10⁻⁴ cm) in diameter on the retina. Calculate the irradiance on the retina of the eye due to this accidental exposure.

Area of the spot: $A = \pi r^2$

$$A = [\pi] \left[\frac{16 \times 10^{-4} \text{ cm}}{2} \right]^2$$

$$A = 2.01 \times 10^{-6} \text{ cm}^2$$

Irradiance at retina: $E = \frac{P}{A}$

$$E = \frac{1 \times 10^{-3} \text{ W}}{2.01 \times 10^{-6} \text{ cm}^2}$$

$$E = 497.51 \text{ W / cm}^2$$

Example 2 shows that the irradiance at the retina is nearly 200,000 times greater than on the cornea. Thus, laser radiation in the ocular focus creates the worst scenario for the eye. A person should also take care to avoid specular (mirror-like) reflections, which are just as dangerous as viewing the laser beam directly.

Almost all ion lasers are Class 4, which require personal protection and administrative and engineering controls. If you have any questions, consult your laser safety officer.

Troubleshooting

Argon Laser Maintenance & Troubleshooting

Maintenance

Argon-ion and other ion lasers typically operate with high current levels in the gas discharge tube. The high current density on the electrodes will cause them to deteriorate over time. It is recommended to operate the laser at the minimum excitation current needed for the desired output. Reducing the current by a factor of two can extend the lifetime of the gas tube tenfold.

The high operating power of the laser output beam necessitates maintenance procedures that include frequent inspection and cleaning of the cavity mirrors.

Troubleshooting

In addition to electrical failures in the power supply, four other types of problems may cause the laser system to perform improperly:

1. The multi-line, intercavity wavelength selector is not tuned properly.
 - a) This may cause a change in the output wavelength.
 - b) The wavelength selector (usually a diffraction grating) should be realigned by measuring or observing the output wavelengths.
2. The gas tube will not support an electrical discharge, or the output beam power is low.
 - a) Check for low gas pressure due to a leak.
 - b) The gas pressure may also be too high, which is usually the result of overheating or adding gas after prolonged periods of nonuse.
 - c) Check for misaligned mirrors and damaged/dirty optics.
 - d) Check for debris in the bore.
3. The output beam has improper spatial modes with rings or other “optical noise.” Check for:
 - a) Misaligned mirrors
 - b) Damaged or dirty optics
 - c) Debris in the bore
4. The laser beam shifts position (due to “mode cycling” or “mode hopping”).
 - a) Check for misalignment of mirrors.

Obtain and refer to the troubleshooting section of the laser’s user manual.

LABORATORY

Laboratory 2-7

Argon-Ion Laser Operations and Measurements

Purpose

The purpose of this lab is to operate an argon-ion laser and measure its critical parameters.



Safety Precautions

Safety precautions should always be practiced when working with any type of laser. Because the eyes are especially vulnerable, safety considerations must begin first with protection of the eyes. You **MUST NEVER** look directly into the aperture of any laser. You must also avoid specular reflections of laser beams. The argon-ion laser emits invisible radiation as well as visible radiation, so you may not see radiation that could hurt your unprotected eyes. This is why it is important to always control the laser beam. Wear safety glasses when working with any un-terminated laser beams. Make sure that the beam is properly terminated into a nonreflective beam stop before you remove your safety glasses. Again, never look directly into the beam of a laser!

Equipment

1. Edmund Optics 58-453 Argon-Ion Laser” (including operating manual and specification data sheet)
2. Edmund Optics 56-462 Argon Laser Safety Eyewear
3. Coherent 1098314 PM30 – 30 W Thermopile Sensor (including operating manual)
4. Coherent 1104619 LabMax – TO Laser Power/Energy Meter (including operating manual)
5. DataRay Beam Analyzer (including operating manual)

6. DataRay CUB Wedge Beamsplitter (3–10%)
7. Ocean Optics Red Tide Spectrometer, Fiber, and Collimating Lens (including operating manual)

Pre-Lab Familiarization

1. Use the Internet to find the laser safety class of the Edmund Optics 58-453 argon-ion laser. What major safety precautions specific to this class of laser must be followed?
2. Read the specification data sheet in the argon-ion laser user manual, and record the following information:
 - a) Wavelengths = _____
 - b) Expected output-power levels / wavelength

Wavelength	Expected Output Power

- c) Expected multi-line output power = _____
 - d) Expected beam diameter= _____
 - e) Spatial mode = _____
 - f) Polarization ratio = _____
 - g) Expected beam divergence = _____
3. Read the following manuals:
 - a) Edmund Optics 58-453 Argon-Ion Laser operating manual
 - b) Coherent 1098314 PM30 – 30 W Thermopile Sensor operating manual
 - c) Coherent 1104619 LabMax – TO Laser Power/Energy Meter operating manual
 - d) DataRay Beam Analyzer user manual.
 - e) Ocean Optics Red Tide Spectrometer user manual.

Procedures

1. Use the instructions in the operating manual to set up the argon-ion laser in the multi-line mode.
2. Use the power meter to measure the laser’s output power. Compare this output power reading with the expected output power given by the laser specification. Record your results.
 - a) Measured multi-line output power = _____
 - b) Expected multi-line output power = _____

- c) Percent difference between measured and expected output power = _____
 - d) Is the multi-line output power within 10% of the expected value? _____
 - e) List some issues that could result in low output power.
3. Design a set-up to observe the beam profile. Using your design, measure the beam divergence and the ellipticity of the laser beam. **(Caution: Make sure you do not exceed the beam analyzer's maximum input power! Refer to Attachment I, beginning on page 26, on "Beam Profile Measurements." Hint: If necessary, use the CUB beam splitter; follow the instructions in the beam analyzer user manual.)**

If you use the DataRay Beam Analyzer in your design, the following instructions may help you measure divergence and ellipticity:

- a) Initiate the WinCamD software on the PC.
- b) Position the laser output aperture and WinCam CCD camera detector so they are separated at least 750 mm. Direct the laser energy onto the camera detector neutral density (ND) filter. If you are using the beam splitter as described in Attachment 1, position the beam splitter output face and WinCam camera detector at least 750 mm apart.
- c) Remove the dust cap from the camera, but make sure not to remove the ND filter that protects the CCD detector.
- d) In the WinCamD software, left click on the "G" icon. This begins data collection for beam profiling. If the camera is correctly positioned, a beam profile will begin forming on the monitor of the PC.
- e) Position the camera detector to center the profile being generated.
- f) When it appears that the beam profile is no longer significantly changing, left click on the "S" icon. This stops data from being taken and leaves the existing profile on the PC.
- g) Left click in the "Clip (a)" window of the display to initiate the "Clip level entry" window.
- h) Enter the distance between the source (laser aperture) and the camera detector into the "Source to imager distance in mm" data box in the "Clip level entry" window.
- i) Enable the angular divergence by left clicking the "Enable Angular Divergence" box. Make sure that the "Full angle in milliradians" box is selected.
- j) Answer "Yes" to any questions regarding measurement of angular divergence.
- k) Left click "OK" in the "Clip level entry" window.
- l) The angular divergence will be displayed in the "2Wua@13.5%" & "2Wva@13.5%" windows.
- m) Click and drag in the 3D box to change the view of the 3D image.
- n) Once the desired beam profile has been captured and is ready to print, press "Print Screen" on the PC keyboard to capture the screen of the WinCamD software to the PC clipboard. Open a Word file, and press "Ctrl V" to transfer the clipboard data to the Word file. Use a thumb drive to transfer the file to a PC from which the file can be printed.

4. Record the divergence, as measured by the beam profiler. Compare your measured beam divergence to the expected divergence listed in the laser specifications.
 - a) Divergence = _____
 - b) Expected divergence = _____
 - c) Percent difference between measured and expected values of divergence = _____
5. Record the ellipticity of the laser beam as displayed by the beam profiler.
 - a) Ellipticity = _____
6. Capture and store a screen shot of the beam profile image. Include this image with your lab report.
7. Design a set-up to analyze the spectrum of the argon-ion laser in the multi-line mode using the spectrometer. (**Caution: Make sure you do not exceed the maximum input power of the spectrum analyzer! Hint: You may have to use a beam splitter or a reflection (i.e., a Fresnel reflection from a prism surface) to limit the input irradiance into the spectrometer.**)
8. Record the wavelength of each major laser output line, as displayed by the spectrometer.
 - a) Wavelengths _____, _____, _____, _____.
9. Using the spectrometer and argon-ion laser operating manuals, set up the laser to operate in a single-line mode (such that the output contains only one wavelength of light). Using the power meter and the spectrometer, measure the wavelength and output power of each individual line generated by the laser. Record these measurements in Data Table 1. Compare the measured power of each individual line with the expected output power.

Data Table 1

Wavelength	Output Power Measured	Output Power Expected	% Difference
457 nm			
488 nm			
514 nm			

10. Select one output line. Design a set-up to measure the wavelength of the line using a diffraction grating. (**Hint: Depending on the spacing between the lines on the diffraction grating, there will be some spatial difference between the center bright spot and the next bright spot to the left or right of the center bright spot. The wavelength of the output can be calculated from measurements of this spatial difference.**) In Data Table 2, record the calculated wavelength and compare it to the actual wavelength.

Data Table 2

Measured Wavelength	Actual Wavelength	% Difference

Attachment I

During the lab, you will use the DataRay WinCamD laser beam imager. When using the WinCamD, it is extremely important not to exceed the maximum power input of the unit. Exceeding the maximum power of the unit could damage the neutral density (ND) filter or CCD detector. Use the following steps to determine whether the laser beam power exceeds the maximum input power of the WinCamD unit:

1. Measure the power out of the laser under test.
2. Measure the beam diameter of the laser under test. Multiply this diameter by 13.5% to find the adjusted beam diameter.
3. Refer to beam imagers “Saturation Beam Power / Pulse Energy Graphs” and determine the maximum permissible power for the wavelength being measured. The lines on the graph (in order from top to bottom: 400 nm, 500 nm, 1064 nm, 675 nm, 800 nm) represent the maximum power permissible for a particular wavelength.

Beam Profile Measurements

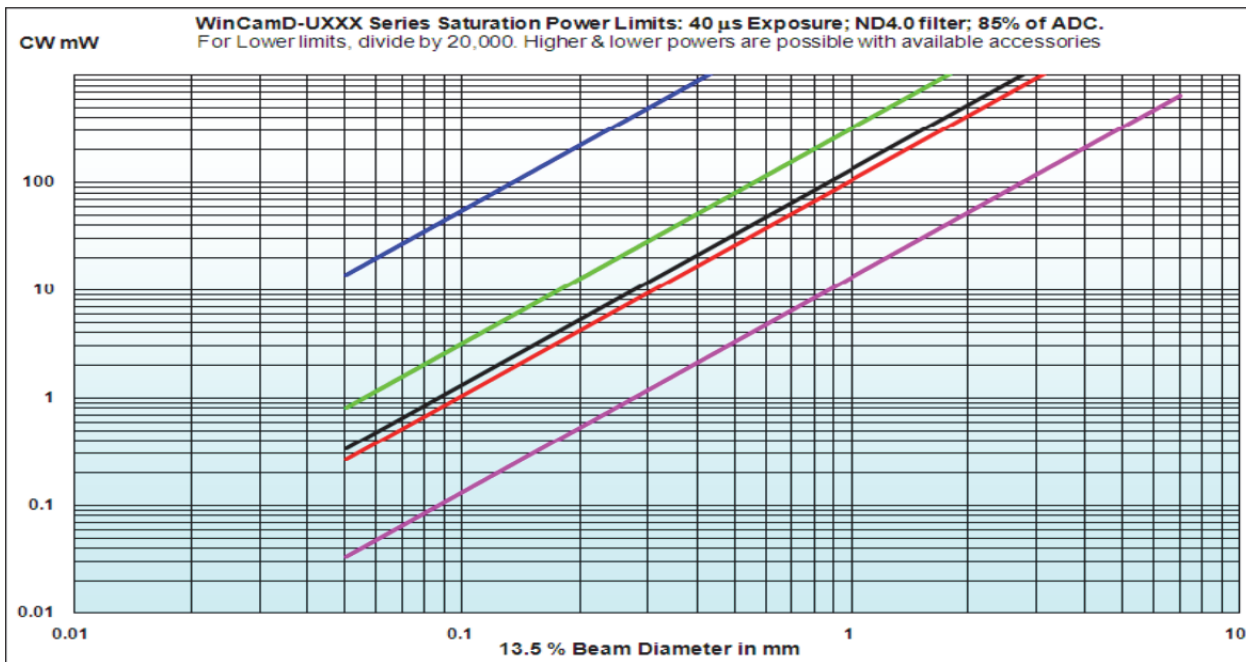

4. Locate on the horizontal axis of the graph the adjusted beam diameter, calculated in step 2 of this attachment.
5. Move vertically up the graph to the wavelength being measured.
6. At the intersection of the wavelength being measured and the adjusted beam diameter of the laser, use the vertical main axis to determine the maximum power permissible at that wavelength and adjusted beam diameter. (**Note: the vertical scale is in milliwatts, NOT watts!**)
7. In step 1 of this attachment, you measured the power. In step 6 of the attachment, you determined the maximum power permissible at the laser operating wavelength and calculated adjusted beam diameter. If the power measured in step 1 is *less than* the maximum power permissible at this wavelength and adjusted beam diameter, then continue with step 3 of the laboratory. If the power measured in step 1 *exceeds* the maximum power permissible at this wavelength and adjusted beam diameter, then you must attenuate the laser's output power to a level that is under the maximum power permissible. Use the CUB beam splitter to attenuate the output power of the laser. The beam splitter has a 5% output. Calculate 5% of the power output of the laser that you measured in step 1 of the attachment, and if the calculated 5% is within the maximum permissible allowed into the laser beam profiler, then install the beam splitter into the path of the laser, with the output of the laser pointed into the input of the beam splitter. Then measure the power out of the 5% port of the beam splitter. If the power measured at the 5% beam splitter output is within the maximum permissible allowed into the laser beam profiler, continue with step 3 of the laboratory. **If the output power of the laser cannot be attenuated below the maximum permissible allowed, the DataRay WinCamD laser beam imager CANNOT be used to profile the beam.**

WORKPLACE SCENARIO

Here is your opportunity to use the concepts you have learned in this module to solve an actual problem that could arise in a photonics company. Your instructor will provide directions for developing a solution.

Changing to an Argon-Ion Laser for Holography Application

Scenario

As lead photonics lab technician for a major university, you have been requested by a photonics professor to change the source for a hologram lab set-up. Presently, the professor is using a diode laser, with wavelength 630 nm, as the source. The professor would like to change the hologram set-up to increase the distance from the source to the hologram photographic plate. He is concerned about the coherence length of the diode laser source.

There is an argon-krypton laser in the lab storage room. The professor would like you to investigate whether it would be possible to replace the diode laser with the argon-krypton laser as the source in the new hologram set-up. He would like to keep using the same photographic plates. The argon-krypton laser in the storage room is capable of both multi-line and single-line modes of operation.

Additional Information

You can find the information you need to solve this problem from at least three sources:

1. An explanation of the laser's output characteristics appears in Module 2-7 *Argon-Ion Lasers and Their Applications*.
2. Conduct an Internet search of "argon-krypton laser tutorials."
3. Conduct an Internet search for "holography."

Problem and Tasking

1. Research coherence length, and compare the typical coherence length of a diode laser with that of an argon-krypton-ion laser. Which is greater? Explain why. Why is coherence length important for holography? Document your research findings, and include typical coherence lengths for both a diode laser and the argon-krypton laser.
2. Does the argon-krypton laser have a lasing line that can be used for the hologram set-up if the same photographic plates are used? What is the wavelength of this line?
3. Assume the argon-krypton laser is operational and presently configured in the multi-line mode. Outline in detail the steps necessary for converting the laser to the single-line mode.
4. Create a written solution to the problem, and be prepared to present your findings in an oral presentation.

PROBLEMS EXERCISES AND QUESTIONS

1. Draw and label an energy-level diagram showing important energy levels and transitions in an argon-ion laser. State the wavelength of the two strongest argon-ion laser lines.
2. Explain the processes by which an argon atom in the ground state is excited to the upper laser level, and how it reaches the ionic ground state after stimulated emission. Refer to the energy-level diagram from Exercise 1.
3. Explain two types of competition between laser lines in an argon-ion laser. Give an example of each (other than the examples used in the text) and describe how this affects the multi-line operation of the laser. Refer to the energy-level diagram from exercise 1.
4. Explain the de-excitation process that lowers the population of the lower lasing levels in the argon-ion laser.
5. List and explain four critical factors that must be considered in ion laser tube design.
6. Draw and label a diagram of a segmented laser tube.
7. Explain how each of the following affects the laser's output power:
 - a) Tube current
 - b) Gas bypass channels
 - c) Magnetic field strength
8. Draw the optical cavity of an argon-ion laser with a prism wavelength selector. Explain the selector's characteristics, and explain how various wavelengths are selected for single-line operation.
9. An argon-ion laser has a cavity length of 0.9 m and a linewidth of 2 GHz for the wavelength at which it is operating. Determine the longitudinal mode spacing and the approximate number of modes in operation.

REFERENCES

- Coherent, Inc. 2008. Ion Lasers: Still a Practical Choice. *The Photonics Handbook 2008*. Pittsfield, MA: Laurin Publishing.
- Ready, John F. 1997. Chapter 3 in *Industrial Applications of Lasers*. San Diego, CA: Academic Press.
- Silfvast, William T. 1995. Lasers. Chapter 11 in *Handbook of Optics*, ed. Michael Bass. New York: McGraw-Hill.

INDEX OF TERMS

A

Applications, 17
Auxiliary circuits, 15

C

Cooling system, 16

D

Doubly ionized, 3

E

Efficiency, 6
Electrical systems, 15

F

Frequency doubling, 16

G

Gain, 4

I

Interlock systems, 15
Ion laser tube cooling, 7, 16
Ion laser tube design considerations, 6-7

K

Krypton lasers, 3, 5

L

Laser output, 8-11, 16
Lasing level, 5
Longitudinal modes, 11-12

M

Metal vapor ion laser, 3
Metastable energy state, 4, 5

N

Noble gas-ion lasers, 3

O

Optical cavities, 13
Optical system, 16

P

Population inversion, 4, 5
Power supply, 15

R

Resonator frame, 14

S

Safety considerations, 19
Singly ionized ground state, 3
Solenoid, 8

T

Troubleshooting, 21

Z

Zeeman effect, 11

Nd:YAG Lasers and Their Applications

Module 2-8

of

Course 2, *Laser Systems and Applications*
2nd Edition

OPTICS AND PHOTONICS SERIES



OP-TEC

National Center for Optics and Photonics Education



© 2016 University of Central Florida

This material was developed by the National Center for Optics and Photonics Education, OP-TEC, and is based upon work supported by the National Science Foundation under Grant No. 1144377 and completed under Grant No. 1303732. Any opinions, findings, and conclusions or recommendations expressed in this material are those of the author(s) and do not necessarily reflect the views of the National Science Foundation.

For more information about the text or OP-TEC, contact:

Dan Hull
PI, Executive Director, OP-TEC
316 Kelly Drive
Waco, TX 76710
(254) 751-9000
hull@op-tec.org

Published and distributed by
OP-TEC
316 Kelly Drive
Waco, TX 76710
254-751-9000
<http://www.op-tec.org/>

ISBN 978-0-9983480-7-0

CONTENTS OF MODULE 2-8

Introduction	1
Prerequisite.....	2
Objectives.....	2
Basic Concepts	3
CW Nd:YAG Lasers	3
Components of a Lamp-Pumped CW Nd:YAG Laser	3
Energy Losses in CW Nd:YAG Lasers.....	7
Semiconductor Diode-Pumped Nd:YAG Lasers	11
Frequency Doubling.....	13
Pulsed Nd:YAG Lasers	13
Pulse Pumped Systems.....	13
Q-Switched Nd:YAG Lasers.....	16
Output Characteristics of Pulsed Nd:YAG Lasers	17
Nd:YAG Laser Applications	19
Summary	20
Safety Considerations.....	21
Troubleshooting	22
Laboratory	23
Workplace Scenario	29
Problem Exercises and Questions	31
Reference.....	32
Index of Terms	33

Module 2-8

ND:YAG Lasers and Their Applications

INTRODUCTION

In this module, we will describe the operation of solid state lasers by highlighting one particular kind, the Nd:YAG. What sets solid state lasers apart from other lasers are their lasing mediums, which are often configured as solid cylindrical rods. These rods are made from a wide variety of materials that are doped with small amounts of an impurity that emits laser light at a wavelength that is transparent in the rod material. For instance, the rod material of the Nd:YAG laser is yttrium aluminum garnet (YAG) doped with the impurity neodymium (Nd). The Nd produces laser light at a wavelength of $1.06\ \mu\text{m}$, which is readily transmitted (transparent) through the YAG material.

Two problems are inherent in Nd:YAG lasers: heat removal and low operating efficiency. To help you address these problems, we dedicate a significant part of this module to explaining each of them. We explain how heat energy is generated in a Nd:YAG laser, and why this heat energy can degrade the laser's performance or damage its components. We then demonstrate techniques for removing this heat from the laser system. We also want to provide you an understanding of why Nd:YAG lasers are inefficient and describe methods of increasing their efficiency.

We start our discussion of Nd:YAG lasers by presenting these lasers' basic components, operating principles, general characteristics, and subsystems. Next, we explain the inefficiency of a CW lamp-pumped Nd:YAG laser by analyzing the power flow and conversion through each component of the system. Then, we turn to the characteristics of the more efficient diode-pumped Nd:YAG lasers, in which semiconductor diode lasers are used to excite the laser action. Finally, since Nd:YAG lasers can also operate in pulsed mode, we examine pulsed Nd:YAG lasers and provide detailed descriptions of their basic components, output characteristics, and applications. We identify safety hazards associated with these lasers and methods for reducing eye and electrical hazards.

In the laboratory, students will practice operating and measuring the output of an Nd:YAG laser in both the CW and pulsed modes.

PREREQUISITE

OP-TEC's *Fundamentals of Light and Lasers Course*

OP-TEC's *Laser Systems and Applications Course, Module 1: Laser Q-Switching, Mode Locking, and Frequency Doubling; Module 2: Laser Output Characteristics and Module 3: Laser Types and Applications*

Understanding of high school level trigonometry and algebra concepts, including exponentials and logarithms

OBJECTIVES

Upon completion of this module, the student should be able to:

- Define solid state lasers.
- Name several solid state lasers.
- Reproduce a simplified Nd:YAG energy-level diagram.
- Present a brief general description of the following subsystems of CW Nd:YAG lasers:
 - Laser rod
 - Optical pumping system
 - Optical cavity
 - Cooling system
- Explain the term “operating efficiency.”
- Draw and label a diagram showing the power flow in a CW Nd:YAG laser. The diagram should illustrate, list, and explain all power losses, starting with external power entering the laser and continuing through the emergence of the output laser beam.
- For a CW lamp-pumped Nd:YAG laser system, given the output power of the laser, make appropriate approximations and calculations to determine the necessary water flow rate and the total temperature rise in the cooling water as it cools the entire system.
- Explain why xenon flashlamps are used with pulsed Nd:YAG systems, even though krypton provides better spectral matching.
- Explain how the spectral match of xenon to neodymium may be improved.
- Explain how transmission of the output coupler is chosen for a Nd:YAG laser.
- Explain methods of rod and lamp cooling employed in pulsed Nd:YAG lasers. Include a description of the two configurations used to deliver coolant to the rod and lamps in liquid-cooled systems.
- Explain the importance of coolant temperature in liquid-cooled pulsed Nd:YAG lasers and the effects on laser performance if the coolant temperature is too high or too low.

- Draw and label a diagram of the output pulse of a typical pulsed Nd:YAG laser and explain the origin of spiking in the laser output.
- Discuss eye hazards and electrical hazards present in pulsed Nd:YAG lasers.
- Operate and the measure the output characteristics of a CW Nd:YAG laser system and a pulsed Nd:YAG laser system in the laboratory.

BASIC CONCEPTS

The most widely used solid state laser is the Nd:YAG, in which the active laser material is a small amount of neodymium (element number 60 in the periodic table, chemical symbol Nd) and the host material is yttrium aluminum garnet (YAG, chemical formula $Y_3Al_5O_{12}$). This composition of lasing material results from a crystal growth process for Nd:YAG crystals that yield a relatively large boule of crystalline material, from which cylindrical rods are cut. During the crystal growth process, neodymium substitutionally replaces yttrium in the crystalline lattice and is present in an ionized state (Nd^{3+}). The amount of neodymium is typically around 1%, although it is the active laser material.

Nd:YAG lasers are not the only type of solid state lasers. There are a number of other solid state lasers—for example, ruby (chromium-doped aluminum oxide), which was the first laser ever operated; neodymium-doped glass (Nd:Glass); neodymium-doped yttrium vanadate (Nd:YVO₄); neodymium-doped yttrium lithium fluoride (Nd:YLiF); and ytterbium-doped yttrium aluminum garnet (Yb:YAG). But Nd:YAG lasers are by far the most common type and are the focus of this module.

CW Nd:YAG Lasers

Components of a Lamp-Pumped CW Nd:YAG Laser

CW Nd:YAG lasers are available in output powers from a few milliwatts to as high as the multikilowatt range. Although they vary considerably in size and complexity of design, all have the same basic elements, shown in Figure 8-1. The active medium is a Nd:YAG laser rod. It is optically pumped by a continuous-pump lamp (often arc lamps) and is placed between two external mirrors that form the optical cavity for the laser beam. This section discusses each of the basic subsystems.

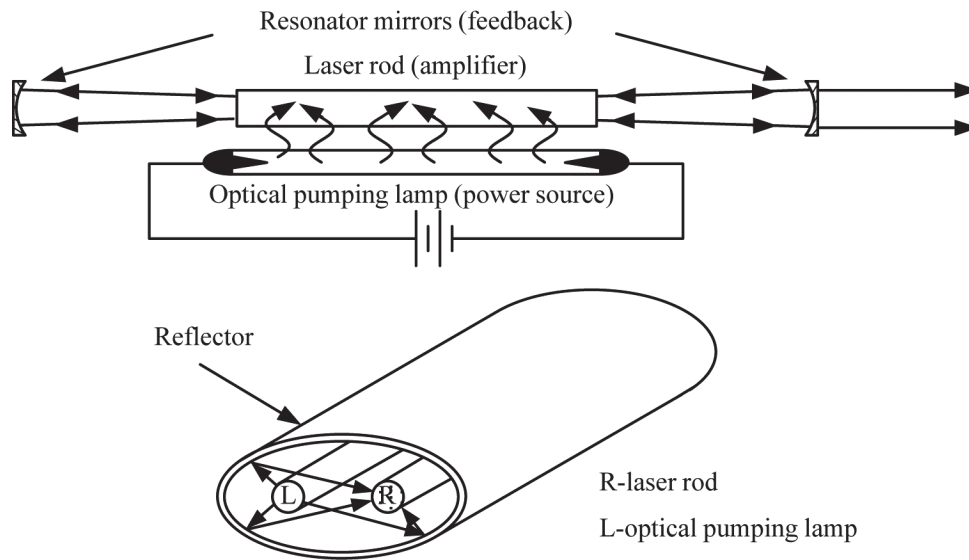

Figure 8-1 Basic design of CW Nd:YAG lasers with elliptical reflector

Laser Rod

Yttrium aluminum garnet (YAG) is a hard, clear crystal with high thermal conductivity. It is strong and durable. The addition of a small amount of the rare earth element neodymium gives the crystal a purple tint. The neodymium atoms embedded in the YAG crystal are typically in a triply ionized state. The absorption spectrum of the Nd:YAG composite (See Figure 8-5.) consists of sharp spikes within closely packed wavelength bands; the two dominant bands are in 730-760 nm and 790-820 nm infrared regions.

The rods in a Nd:YAG laser are designed to optimize the production of laser light. The Nd:YAG rods used for CW operation are usually from .04 to .16 inches in diameter and have lengths from one inch to about six inches. Smaller-diameter rods are preferred because they present fewer cooling problems than larger rods. The rod ends usually have antireflection coatings that are effective at the Nd:YAG wavelength of 1.06 μm . The rod is mounted inside a quartz or glass water jacket. Cooling is provided by water flow directly across the rod surface. The rod ends are held in place and sealed by O-rings recessed in the ends of the rod holders to protect them from the pump lamp light.

The relevant electronic energy levels for Nd:YAG laser operation are shown in Figure 8-2 in a simplified form.

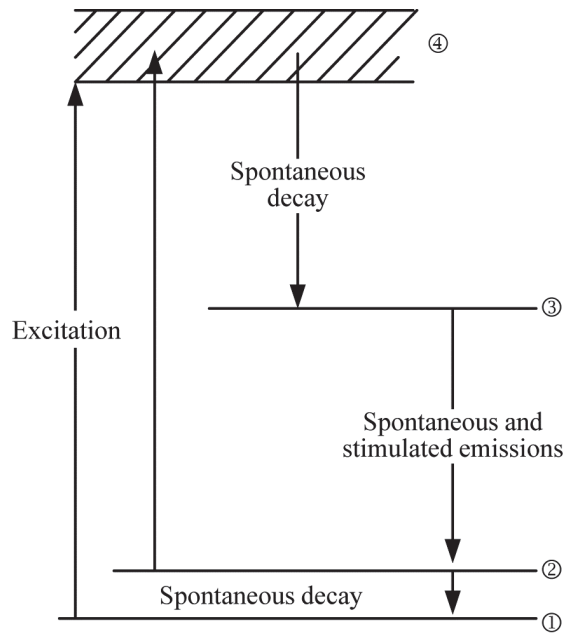

Figure 8-2 Energy Levels of the Nd:YAG Laser

As depicted in Figure 8-2, the Nd:YAG laser is a four-level system. The light in the pump lamp raises the neodymium ion from its ground state, labeled 1, to a higher energy level state, labeled 4. From this state, the ion spontaneously decays to the upper laser level (metastable state), labeled 3. Because the lasing material is only approximately 1% neodymium, only a small number of neodymium ions must be raised to the upper laser level to establish a population inversion. Once a population inversion is established, stimulated emission within the laser cavity causes the neodymium ions to drop from their metastable state to the lower laser level, labeled 2. This transition from the metastable state to the lower laser level produces photons with a wavelength of 1064 nm. From the lower laser level, the neodymium can spontaneously decay to the ground state, where pump light can again raise it to state 4.

The Nd:YAG laser design has several advantages, including the ability to produce laser light at more than one wavelength. Because the Nd:YAG laser is a four-level system with the lower laser level lying above the ground state, it is easier to obtain a population inversion than in three-level systems. Additionally, the combination of the high thermal conductivity of the YAG crystal and the four-level energy structure of the Nd:YAG works to increase the production of laser light and remove the excess heat that results.

The Nd:YAG composite also supports the production of laser light at a wavelength of 1320 nm. To select this wavelength as an output for the Nd:YAG laser, the mirrors within the laser cavity used to produce 1064nm light are replaced with mirrors that have high reflectivity at 1320nm. The 1320 nm wavelength emission is used for some specialized applications, but is much less common than the 1064 nm wavelength.

Now that you have an idea of how laser light is generated in an Nd:YAG laser, we will briefly describe the components that contribute to this light production.

Optical Pumping System

The optical pumping lamp for CW Nd:YAG lasers stays on continuously during the operation of the laser and is either a tungsten-filament lamp (also called a quartz-iodide lamp or

quartz-halogen lamp) or a krypton arc lamp. (Arc lamp is a general term for a class of lamps that produce light by an electric arc.) If a quartz-halogen lamp is used, cooling is applied to the lamp ends. Krypton arc lamps are generally enclosed in their own water jackets and have water cooling for the lamp cathode. Krypton arc lamps provide a better match to the absorption spectrum of Nd:YAG but are more expensive.

The bottom drawing in Figure 8-1 shows a single lamp inside an elliptical pump cavity that reflects light efficiently on the rod. Other pump cavity designs have more than one lamp. The lamps are usually mounted with the laser rods inside the elliptical pumping cavity, which is water cooled and, in some models, may be flooded. Often, the inside of the cavity is coated with one of several materials. Gold is the best reflector for the pump light, but it is not extremely durable. Chromium plating is often used and provides a good compromise between reflectivity and durability. Both single and double elliptical cavities are common.

Laser Cavity

The laser cavity (also called the optical cavity) of the Nd:YAG laser usually consists of two mirrors mounted separately from the laser rods, as illustrated in the top drawing of Figure 8-1. Several cavity configurations may be used, but all employ at least one spherical mirror. Both long radius and long radius hemispherical cavities are commonly employed. In some systems, shaping of the beam within the cavity is desirable, and two mirrors with different radii of curvature are used. The high-reflectivity (HR) mirror has a reflectivity of about 99.9%, and the output coupler transmission varies from less than 1% on small power lasers to about 8% on larger power ones. The optical cavities of Nd:YAG lasers are often equipped with an adjustable or interchangeable aperture for selection of multimode or TEM₀₀ mode operation.

Cooling System

The cooling system is one of the most critical subsystems in a Nd:YAG laser. Smaller power lasers may use open-loop cooling systems with tap water flowing across the rod. In such cases, the water is filtered to remove any contamination or impurities. Larger power systems use closed-loop cooling with water or a water-glycol solution. The coolant is usually refrigerated, but a water-to-water or water-to-air heat exchanger may also be employed.

The cooling fluid circuit begins with the laser rod. The water then flows across the lamps and the laser cavity. A flow switch is generally included to turn off the lamp power if the water flow is interrupted. Loss of cooling will quickly destroy seals, lamps, and the laser rod itself.

Lasing in Nd:YAG is dependent upon rapid transitions from the lower lasing level to the ground state. These transitions occur at a high rate only if the rod temperature is low. Thus, lasing efficiency depends very strongly upon cooling efficiency. For example, at temperatures just below the damage threshold of the rod, all lasing action will cease entirely—an effective fail-safe mechanism. If the cooling water is too cold, however, condensation will form on the laser head and optical surfaces. This can lead to problems and should be avoided. Cooling systems are generally operated at temperatures just above the threshold of this effect.

Energy Losses in CW Nd:YAG Lasers

The *operating efficiency*, η , of a CW laser (also called the *wall-plug efficiency*) is the percentage of input electrical power converted into laser output power and is given by Equation 8-1.

$$\eta = \frac{P_{\text{out}}}{P_{\text{in}}} \times 100 \quad (8-1)$$

where: P_{out} = Output power of the laser beam
 P_{in} = Input electrical power

The output power is measured with an optical power meter or calorimeter, and the input power is measured with an electrical wattmeter. The operating efficiency in most lamp-pumped Nd:YAG lasers is between 1% and 4%.

Since “continuous wave laser” means that the laser is operating continuously over some time period, it is assumed that any CW laser studied or analyzed has been operating a sufficient length of time to have reached *equilibrium conditions*. This means that all the inputs, outputs and temperatures have reached a constant, steady-state level and are not changing significantly. Under these conditions, for any fixed period of time, energy is proportional to power. This portion of the module discusses only lasers operating in CW mode that have reached equilibrium conditions. Thus, any statements about energy input, output, or losses also apply to power input, output, or losses.

Figure 8-3 is a schematic diagram that accounts for all the important power losses in a CW Nd:YAG laser system during steady-state operation.

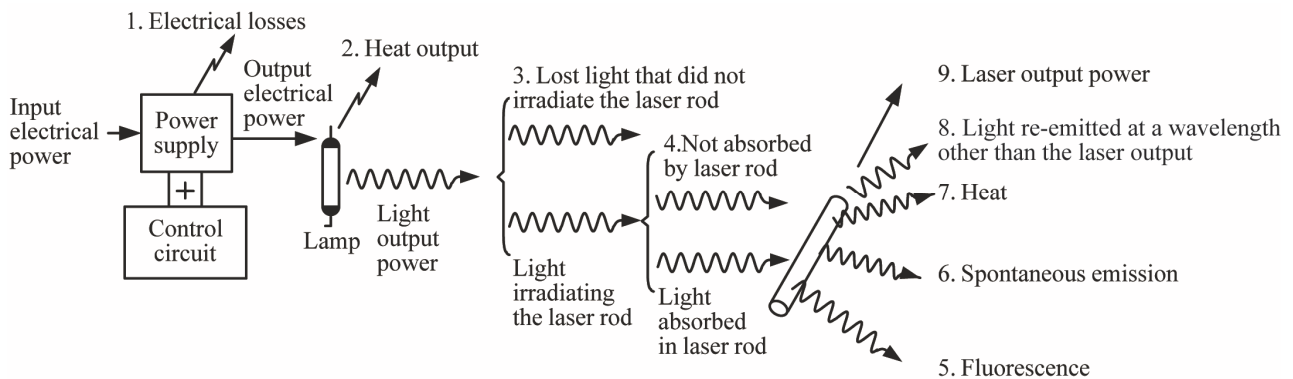

Figure 8-3 CW solid state laser efficiency diagram

Let’s now examine each of the loss mechanisms shown in Figure 8-3.

Electrical power supply losses: These losses are the result of resistance losses in leads, connectors, transformers, variacs, meters, and lights and of inefficiencies in other electrical components of the power supply, such as hysteresis, capacitor leakage, and filters. The amount of these combined losses can be roughly determined by subtracting output power from input power. For commercial equipment, these quantities can often be obtained from the manufacturer’s specification sheet or the equipment user manual. As a rule of thumb, DC power supplies in the kilowatt power sizes are about 80% efficient.

Heat output from the lamp: If the lamp has an incandescent filament (usually tungsten), the source of light is the radiation from the hot filament. This is a very close approximation to a *blackbody radiator*, and its output has a broad, continuous wavelength spectrum ranging from the ultraviolet to the infrared. These lamps are usually less than 30% efficient for pumping Nd:YAG lasers. If the lamp is a gas tube (usually xenon or krypton gas), the heat output comes from three sources: (a) heating of the electrodes from the high current density and electron bombardment in the ionized gas, (b) heat generated within the gas, (c) absorption of the light by the lamp envelope (glass or quartz tubing). Efficiencies of CW gas arc lamps are about 30%.

Light from the lamp that does not irradiate the laser rod: Light from the lamp is emitted in all directions and usually requires a reflector around the lamp and laser rod to focus or redirect the light onto the laser rod. Although the reflectors are usually highly polished metal or magnesium oxide and have high reflectivity (90%), many rays from the lamp do not reach the rod in a single reflection. They may require five or six reflections, or they may never reach the rod. However a good reflector should be at least 80% efficient.

Light output power irradiating the laser rod but not being absorbed: This can be caused by two phenomena. First, if a light ray from the lamp strikes the surface of the laser rod at a low or “grazing” angle, it is mostly reflected and does not significantly enter the laser material. Second, the laser material absorbs only certain wavelengths of light. Some of the light is at wavelengths not in the absorption bands of the laser material.

Laser-rod power losses: These losses all pertain to physical mechanisms that take place at the atomic level in the laser material. They include fluorescence, spontaneous emission of light at the laser output wavelength, absorbed light converted to heat through crystal lattice vibrations, and light reemitted at a wavelength other than the laser output. Laser output from the laser material results only from stimulated emission of light at the proper wavelength and along the optical axis of the laser.

Cooling System Calculations

The cooling system of the Nd:YAG laser must remove most of the waste heat from the entire system. Only a small fraction of the input energy appears in the laser output. Other relatively small amounts of energy escape as fluorescence that passes through the rod ends and as radiative or convective heating of the laser environment. The cooling system must be capable of removing waste heat continuously at the maximum-output power level. The technician is often the person who maintains, diagnoses, and repairs cooling systems. Hence it is important for the technician to understand cooling systems’ basic dynamics.

Example 1 illustrates these dynamics and how you can design a Nd:YAG laser cooling system.

Example 1

Cooling System Design for Nd:YAG Laser

Given: A CW Nd: YAG laser with 3333 W of electrical power input to a tungsten lamp requires a cooling system that will limit the temperature rise in the rod coolant to 3°C. The laser output is 7 W. The laser is at equilibrium conditions, and all its inputs, outputs and temperatures have reached steady-state values.

Find: Water flow rate and total temperature rise in cooling water.

Solution:

1. Estimate the amount of power absorbed by the rod.
 - a) Power-supply losses can be measured. (For this problem, assume that the power supply is 80% efficient.)
 - b) Percentage of lamp-input power converted to light. (Assume this is 30%).
 - c) The percentage of lamp output (incident on the rod) absorbed by the laser can be estimated by comparing the output spectra with the absorption spectra of the rod. (For this problem, assume that 30% of the output is absorbed.) This is the percentage of pump light delivered to the rod.
 - d) Assume that the pump lamp reflector is 90% efficient.

Total power absorbed in the laser rod:

$$(3333 \text{ W})(0.8)(0.3)(0.3)(0.9) = 216 \text{ W}$$

2. Estimated the amount of heat (H_{LR}) that must be removed from the laser rod:

a) Total power absorbed = 216 W

b) Output laser power = 7 W

$$H_{LR} = 216 - 7 = 209 \text{ W}$$

3. Convert units of heat power from watts to calories/second.

$$H_{LR} = 209 \text{ W}$$

$$1 \text{ W} = \frac{\text{J}}{\text{s}}$$

$$H_{LR} = 209 \text{ J/s}$$

$$1 \text{ cal} = 4.18 \text{ J}$$

$$H_{LR} = \frac{209}{4.18} = 50 \text{ cal/s}$$

4. Determine the coolant flow rate required to limit the temperature rise in the coolant passing over the laser rod to 3°C. Assuming that the laser is operating in an equilibrium condition, we can use Equation 8-2 to calculate the coolant flow rate needed to maintain a specified rise in the coolant temperature:

$$Q = mc\Delta T \quad (8-2)$$

Where Q is the heat added to the coolant every second, m is the mass of the coolant flowing through the laser system each second, c is the specific heat capacity of the coolant, and ΔT is the rise in coolant temperature. For our problem, c is the heat capacity of water, which is $1 \text{ cal/g}^\circ\text{C}$; Q is 50 cal/s (amount of heat that must be removed from the laser rod each second) and ΔT is 3°C (allowed temperature rise in the laser rod coolant). Solving for m in Equation 8-2, the following results:

$$m = Q/(c\Delta T) = 50 \text{ cal}/(1 \text{ cal/g}^\circ\text{C} \times 3^\circ\text{C}) = 16.7 \text{ g.}$$

Based on these calculations, we must have 16.7 g of water moving over the laser rod every second to limit the temperature rise in the coolant to 3°C . To put this into more familiar terms, we know that as a liquid under normal atmospheric conditions, 1 g of water occupies approximately 1 cm^3 of volume. So we would need a flow rate of 16.7 cm^3 of coolant water every second flowing through the laser. Since there are 2.6×10^{-4} gallons in each cm^3 of water, this means that the required number of gallons that must flow through the laser each second is:

$$\text{Flow rate} = 16.7 \text{ cm}^3/\text{s} \times 2.6 \times 10^{-4} \text{ gal/cm}^3 = 4.3 \times 10^{-3} \text{ gal/s}$$

Thus, the flow rate over the laser rod required to limit the temperature rise of the coolant to 3°C is $4.3 \times 10^{-3} \text{ gal/s}$. Converting to minutes, the flow rate becomes:

$$\text{Flow rate} = (4.3 \times 10^{-3} \text{ gal/s} \times 60 \text{ s/min}) = .26 \text{ gal/min.}$$

- Determine the temperature rise in the coolant water after it passes through the cavity/reflector region of the laser. The amount of power that must be extracted from the cavity/reflector region of the laser and transferred to the coolant (P_{CR}) is the input electrical power minus any power that is loss or extracted from the laser system. In our example, one loss term is the electrical losses that occur due to inefficiencies in the power supply. Also, we have two mechanisms by which power is extracted from the system. The first is the power that escapes the laser as its output. The second is the power we have already extracted from the laser rod that resulted in the coolant temperature rising 3°C . We can mathematically represent the power deposited in the cavity /reflector region using the following equation:

$$P_{CR} = P_{in} - (\text{power supply losses} + \text{laser output} + \text{power extracted from rod})$$

$$P_{CR} = 3333 \text{ W} - ((.2 \times 3333 \text{ W}) + 7 \text{ W} + 209 \text{ W}) = 2450 \text{ W}$$

$$P_{CR} = 2450 \text{ J/s} \times (1/ 4.18 \text{ J/cal}) = 586 \text{ cal/s}$$

Thus, every second 586 cal of heat is deposited in the laser cavity/reflector region and must be removed by the coolant.

We must now calculate the rise in temperature of the coolant as it passes through the cavity and reflector region of the laser. Using Equation 8-2 and again assuming that the laser is operating in an equilibrium state, we solve for ΔT :

$$\Delta T = Q/mc$$

$$\Delta T = 586 \text{ cal}/ (16.7 \text{ g} \times 1 \text{ cal/g}^\circ\text{C}) = 35.1^\circ\text{C}$$

If 16.7 g of coolant are passing through the cavity/reflector region of the laser each second (.26 gal/min) and 586 cal of heat are removed, then in passing through this region, the coolant will increase in temperature by 35.1°C.

The total rise in coolant temperature as it passes through the Nd:YAG laser is the sum of temperature rise caused by the laser rod, 3°C, and the temperature rise resulting from heat extracted from the cavity/reflector region, 35.1 °C. The total rise in coolant temperature as it circulates through the laser system is:

$$\Delta T_{\text{tot}} = 3^{\circ}\text{C} + 35.1^{\circ}\text{C} = 38.1^{\circ}\text{C}$$

A typical coolant temperature in a Nd:YAG laser can have a value of 40°C as it exits a heat exchanger. Using this value and those calculated in Example 1, a coolant flow diagram can be drawn as shown in Figure 8-4. Note in this figure the 3°C rise in coolant temperature due to the laser rod and the 35.1°C rise that occurs in passing through the cavity and reflector region of the laser.

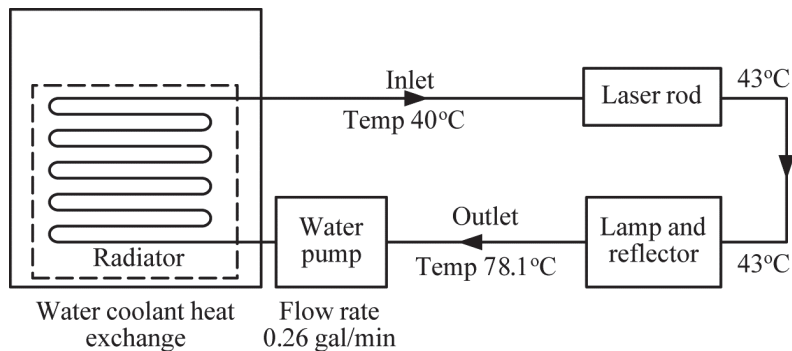

Figure 8-4 CW laser coolant flow diagram (parameter values obtained from Example 1)

Semiconductor Diode-Pumped Nd:YAG Lasers

So far, this module has focused on CW Nd:YAG lasers pumped by tungsten-filament lamps or krypton arc lamps. The operating efficiency of such lasers is low, usually only a few percent. A large part of this inefficiency is due to the power needed to operate these lamps and the mismatch of their output with the light-absorption properties of the Nd:YAG composite. Both these negatives can be overcome by using semiconductor laser diodes as pumping sources.

Semiconductor laser diodes are relatively efficient at converting electrical energy into light output. Also, the wavelength of the diode laser output can be adjusted to overlap the wavelength of a strong line in the absorption spectrum of the neodymium ion. Figure 8-5 shows the absorption spectrum of Nd:YAG and also the emission spectra of some pump sources. As the figure shows, other sources, such as black body sources (for example, a tungsten lamp) and krypton arc lamps, emit much of their output at wavelengths for which the absorption of Nd:YAG is low. But a semiconductor laser designed to operate at a wavelength of 808 nm emits exactly at a wavelength where Nd:YAG has strong absorption. Because of these factors, pumping of Nd:YAG lasers with semiconductor lasers can provide much higher efficiency than pumping with the other lamps described earlier. A diode-pumped Nd:YAG laser can easily have

25% or even higher efficiency, which is substantially greater than a lamp-pumped device. This increase in efficiency also means that there is much less heat to be removed.

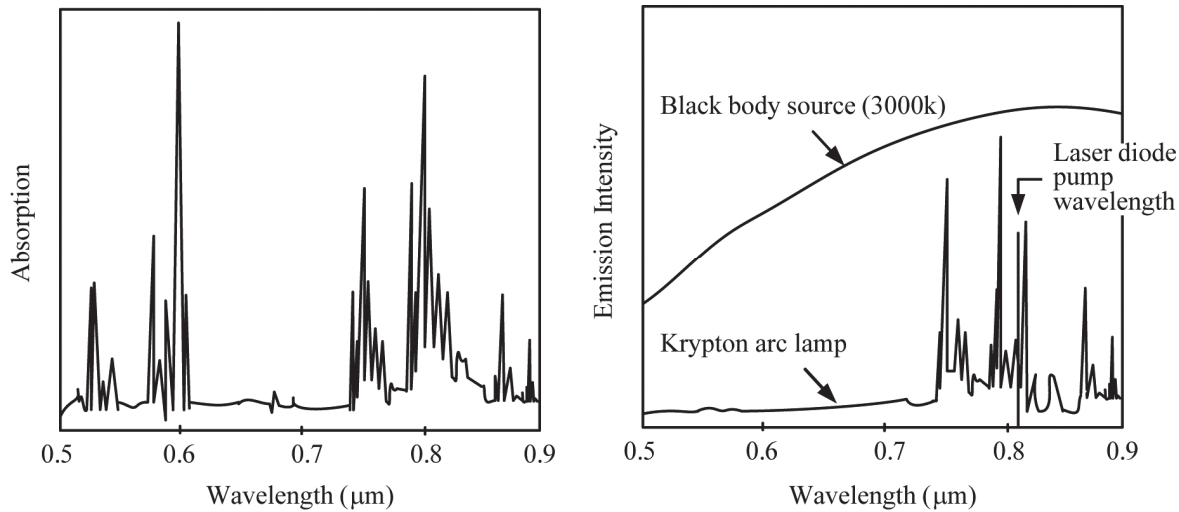

Figure 8-5 Left: Absorption spectrum of Nd:YAG. Right: Emission spectra of some pump sources

Figure 8-6 shows one configuration for a diode-pumped Nd:YAG laser. This is an end-pumped configuration, but other arrangements are possible. The end-pumped configuration is often used for relatively low power devices, but if higher output is needed, the end pumped configuration is not suitable.

Higher powers require larger volumes of Nd:YAG composite. These higher volumes cause pump light from non-semiconductor laser sources to be absorbed in a way that does not fully excite the Nd:YAG rod. Those parts of the rod that are not excited do not contribute to the laser output, thus reducing the total output power of the laser. To overcome this problem, a number of laser diode bars are arranged radially around the laser rod. This configuration is called side pumping. Side pumping increases the amount of pump light incident on the Nd:YAG rod, providing a much higher level of excitation within it. Side pumping is used to produce multikilowatt outputs. But one disadvantage of side pumping is that it may produce somewhat poorer beam quality compared with end pumping.

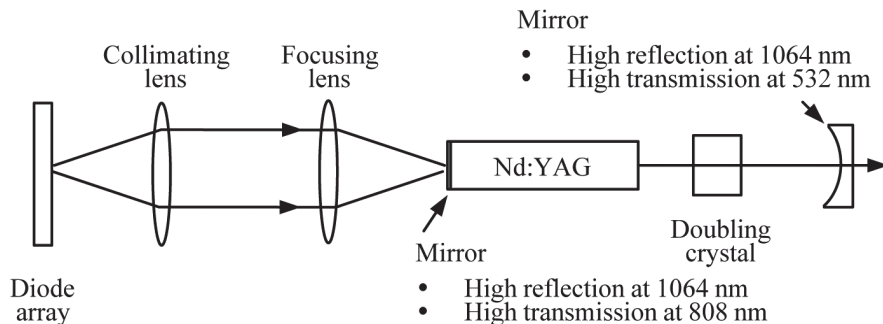

Figure 8-6 End-pumped configuration for a diode pumped Nd:YAG laser

The total size of the laser can be much reduced when pumping is done by laser diodes instead of a lamp-pumped device. Many commercial models of diode-pumped Nd:YAG lasers are

available. Because of their advantages of efficiency, compactness, and lowered pump-power requirements, they have replaced lamp-pumped devices for many applications.

To summarize, diode laser pumping offers a variety of advantages over lamp pumping for solid state lasers:

- Higher efficiency
- Excellent beam quality
- Smaller size
- Low excess heat for many applications
- Scalability to high power

Frequency Doubling

A possible modification for CW Nd:YAG lasers is the addition of a frequency doubling crystal inside the laser cavity, as shown in Figure 8-6. The most common frequency doubling crystals for Nd:YAG lasers are lithium niobate (LiNbO_3) and barium sodium niobate ($\text{Ba}_2\text{NaNb}_5\text{O}_{15}$). The crystals are cut at precise angles for proper phase matching inside the laser cavity. To accommodate this frequency doubled light, the cavity mirrors are both highly reflective at 1064 nm. As a result, the light produced by the Nd:YAG laser stays within the cavity and causes further stimulated emission. The HR mirror is also highly reflective at 532 nm, which keeps the frequency doubled light in the laser cavity until it interacts with the output coupler, which is highly transmissive at 532 nm. Thus, the Nd:YAG laser light is converted from 1064 nm infrared light to 532 nm green light, which forms the output beam. Many models of frequency doubled Nd:YAG lasers are commercially available.

Additional accessories exist for frequency tripling and frequency quadrupling the output of an Nd:YAG laser to wavelengths of 355 nm and 266 nm, which are in the ultraviolet region.

Pulsed Nd:YAG Lasers

Nd:YAG lasers can operate in CW mode, as just presented, or pulse mode. There are two primary methods for pulsing this laser—pulse pumping and Q-switching.

Pulse Pumped Systems

Up till now, we have centered our discussion on continuously pumped Nd:YAG lasers that use lamps or diode lasers as pumping sources. Now we consider Nd:YAG lasers that are pulse pumped by flash lamps and diode lasers. The pulse pumped method involves the normal pulse mode: the flashlamp (or semiconductor diode laser pump) is pulsed, and the laser emission begins when the population inversion is high enough and ends when the population inversion falls below the threshold for laser operation. Such lasers typically have durations in the millisecond region.

As we've explained, the efficiency of CW Nd:YAG lasers is relatively low when they are pumped by lamps rather than diode lasers. This is also true for pulsed Nd:YAG lasers. Even though these lamp-pumped systems are relatively inefficient, there are still many older lamp-pumped pulsed Nd:YAG lasers in use, and lamp-pumped commercial models are still being

sold. For these reasons, we will discuss both lamp- and diode-laser-pumped pulsed Nd:YAG lasers.

Lamp- and Diode-Pumped Systems

Pulsed lamp-pumped Nd:YAG lasers use a cylindrical rod as the active medium. The rod can be optically pumped by a flashlamp, with the light focused into the rod by a pumping cavity. The flashlamp is powered by a pulsed power supply that contains an inductance–capacitance circuit for shaping the input electrical pulse. The optical cavity usually is composed of two plane mirrors or long-radius hemispherical mirrors mounted externally to the rod. Figure 8-7 is a simplified diagram of such a laser.

To understand the operation of these pulse lamp-pumped Nd:YAG lasers, it is important to study the function and design of the individual components used in this laser.

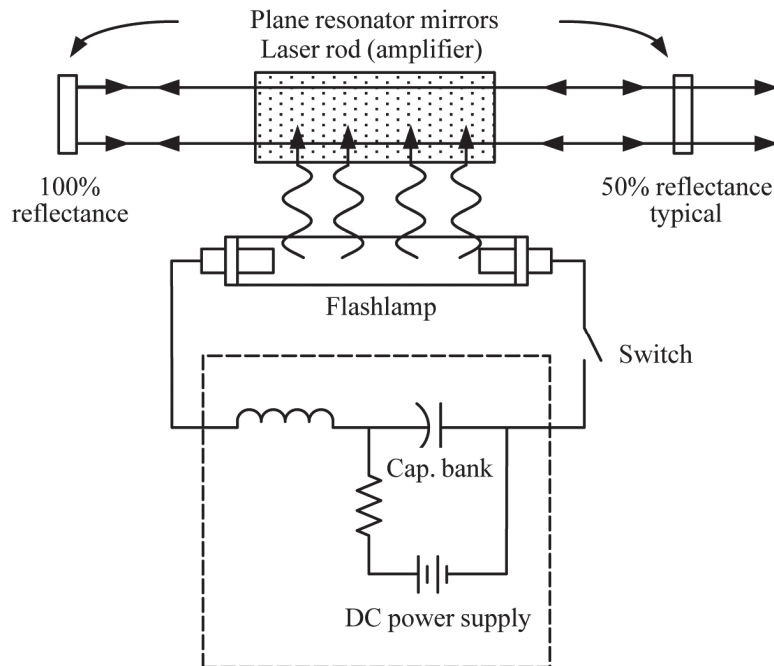

Figure 8-7 Simplified schematic of a pulsed Nd:YAG laser

Laser Rod

The laser rod in a pulsed Nd:YAG laser is a cylinder with a relatively smoothly ground outer surface and optically polished ends. The ends of plane-parallel laser rods are usually coated with antireflection coatings that work effectively at the laser wavelength, although this is not always done. For instance, either or both ends may terminate with a Brewster's-angle surface to minimize surface reflections and eliminate the need for antireflection coatings. Rods with Brewster's-angle ends always produce output beams that are plane polarized in a plane perpendicular to the Brewster's-angle surface. Brewster's-angle rod ends also change the direction of the optical axis inside the laser cavity, as shown in Figure 8-8. This can lead to greater problems with rod mounts and with alignment. For these reasons, the plane-parallel rods are much more popular.

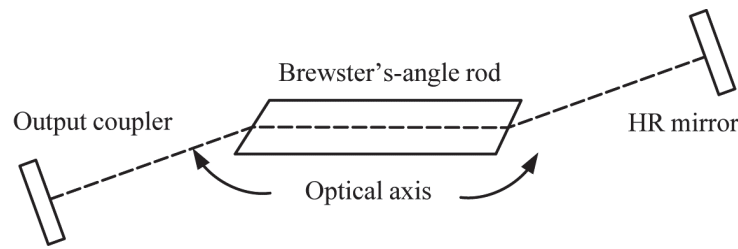

Figure 8-8 *Optical axis of a cavity with a Brewster's-angle rod*

The maximum energy available from a laser rod depends in large part on the volume of the rod. Nd:YAG rods for pulsed systems range in size up to .375 inches in diameter and 6 inches long, although smaller rods such as .25 inch by 5 inch rods are more common.

Optical Pumping System

The optical pumping system for a lamp-pumped laser consists of a flashlamp, a power supply to energize the flashlamp, and an optical pumping cavity to direct the flashlamp light into the laser cavity.

There are two types of flashlamps typically used with lamp-pulsed Nd:YAG lasers. Krypton flashlamps provide a good spectral match for neodymium based laser systems, but they are expensive. Because of this expense, Nd:YAG lasers are usually pumped with xenon flashlamps. To increase their efficiency, the current in xenon lamps is often reduced, which shifts their output spectrum toward the red. This shift allows more light from these lamps to be absorbed in the rod, resulting in more efficient laser operation.

The power supply for the flashlamp is constructed as illustrated in Figure 8-7. The energy-storage capability of the capacitor bank is matched to the maximum energy input of the system. Most industrial systems are designed to provide the maximum pump energy that can safely be used for the rod size. In smaller systems, the maximum design energy per pulse may be well below rod capabilities. The charging supply is designed to provide energy to the energy-storage capacitor at a rate that will allow it to be fully charged during the pulse repetition time of the laser. This may vary from a few shots per minute to as many as twenty per second. In comparison, continuously pumped repetitively Q-switched solid state Nd:YAG lasers, described later, may produce pulse-repetition rates of many kHz.

The most common energy-storage system is a single capacitor and inductor in an RLC discharge circuit, but pulse-forming networks are also often used. Many systems have pulse-forming networks designed so that the number of sections can be varied to change pulse duration.

Pulsed Nd:YAG lasers may also be pumped by semiconductor laser diodes. In some of these models, optical fibers deliver the diode laser light to the Nd:YAG laser rod. The advantages of diode laser pumping have been discussed earlier. These same advantages apply when pulsed Nd:YAG lasers are being excited. But it may be more difficult to provide sufficient pumping energy in a short pulse from semiconductor lasers than from flashlamps.

Laser Cavity

Most pulsed solid state lasers use plane-parallel or long-radius hemispherical optical cavities. The plano-parallel cavity configuration allows maximum use of large-diameter laser rods and has the added advantage of favoring the TEM₀₀ mode. The diffraction loss of the plane-parallel cavity is of no great concern in most Nd:YAG lasers because the cavity gain is sufficient to

overcome fairly high losses. The plane-parallel cavity also avoids focusing the laser light inside the cavity. Focusing the laser beam inside the solid rod can cause damage to it and is typically avoided.

Both mirrors in a Nd:YAG laser are usually external to the rod, but some systems employ rods with one of the mirrors deposited directly on the rod end. The high-reflectance mirror is typically more than 99.5% reflective at the laser wavelength. Transmission of the output coupler varies from system to system, with typical values slightly less than 50%.

Cooling System

Cooling is an important factor in all pulsed Nd:YAG lasers. Without it, the rod temperature increases and laser operation can cease. Typically, cooling is achieved by forcing coolant over the laser's rod and flashlamps. In small systems, such as those used for range finders, the coolant may be either air or nitrogen. Gases do not provide good thermal-energy transfer, but for the relatively low pulse energies of small systems, gas cooling is sufficient, and maintenance of gas-cooled systems is less troublesome. Larger pulsed-laser systems may use gas cooling, but this limits the pulse repetition rate to a value much lower than that available with liquid cooling.

Liquid cooling systems used in pulsed Nd:YAG lasers are nearly identical to those used in CW systems. Water and ethylene glycol are the most common coolants, but other liquids may be used. Two basic cavity designs are used for liquid-cooled systems. In flooded-cavity lasers, the entire pumping cavity is flooded with coolant. The rod and flashlamps are sealed at the cavity ends, and coolant flows through a set of baffles that force it across the rod and lamp surfaces. The second cavity design involves the use of water jackets that enclose both the rods and the lamps. These water jackets generally are sealed with O-ring seals. Cooling water is routed to flow first across the rod, then across the lamps, and finally to any other water-cooled cavity elements, such as reflectors. This provides the lowest temperature and maximum cooling effect for the rod.

Most systems use closed-loop cooling systems with a refrigeration unit to maintain proper coolant temperature. The size of the refrigeration unit necessary depends on the maximum continuous heat load produced when the laser is operated at its maximum average power for long periods of time.

Like CW Nd:YAG lasers, coolant temperature is often a critical factor in the operation of pulsed solid state lasers. Higher temperatures result in lower laser efficiency. Thus, it is generally desirable to operate the system at the lowest temperature practical. If temperature is reduced below the dew point, condensation will begin to form on laser components exposed to the atmosphere. If there is some condensation on the rod ends, but not enough to prevent lasing, the laser beam can burn off the condensation layer and damage rod end surfaces in the process. Thus, Nd:YAG laser systems should not be operated with coolant temperatures low enough to result in condensation.

Q-Switched Nd:YAG Lasers

So far we have described pulsed Nd:YAG lasers operating in what is commonly called the normal pulse mode: the flashlamp (or semiconductor diode laser pump) is pulsed, and the laser emission begins when the population inversion is high enough and ends when the population inversion falls below the threshold for laser operation. Such lasers typically have durations in the millisecond region. We now consider Q-switched Nd:YAG lasers in which the dynamics of

lasing inside the laser cavity is controlled to yield a different type of output than that generated from normal operation.

When using a Q-switch, an optical element (a Q-switch) inserted into the laser cavity holds off the laser operation until a pulse is desired. Then the Q-switch is opened briefly and a short pulse occurs. Because the population inversion has been allowed to build up to a high level, the power may be much higher than without the Q-switch. The Q-switched pulse is also much shorter, usually in the nanosecond range in contrast to the millisecond-range pulse produced by pulsing flashlamps. Typical commercial Q-switched Nd:YAG lasers have pulses of submicrosecond duration and peak powers of megawatts rather than the kilowatts common in normal pulse lasers.

A common type of Q-switched laser is the continuously pumped, repetitively Q-switched Nd:YAG laser. The laser is pumped similarly to the CW lasers, and the Q-switch is turned on and off at a high rate. The Q-switch most frequently used with CW Nd:YAG lasers is an acousto-optical device that introduces little insertion loss in the system and may be operated at pulse repetition rates up to 50,000 pulses per second(pps). Operating a CW-pumped, repetitively Q-switched Nd:YAG laser at 20,000 pps generally results in a peak pulse power that is around 500 times the CW output power of the same laser. The average power in this repetitively Q-switched mode may be as much as 90% of the CW output power. Pulse durations are typically a few tenths of a microsecond.

Because frequency doubling occurs with greater efficiency as the peak power becomes higher, Q-switched lasers are generally used for frequency doubling. Commercial Q-switched Nd:YAG lasers are available at wavelengths of 1064 nm (the fundamental wavelength), 532 nm (frequency-doubled), 355 nm (frequency-tripled), and 266 nm (frequency-quadrupled).

Output Characteristics of Pulsed Nd:YAG Lasers

We begin by describing the output characteristics of normal pulse (that is, non-Q-switched) Nd:YAG lasers.

Figure 8-9 shows the time history of the flashlamp and laser output pulses of a typical pulsed Nd:YAG laser. The flashlamp pulse rises quickly to a peak value and then declines more slowly back to zero. The beginning of the flashlamp pulse establishes a population inversion in the active medium. Lasing begins when the loop gain reaches 1.0 and continues as a series of closely spaced spikes for the duration of the flashlamp pulse. These spikes are produced by gain switching in the active medium. The cavity gain rises quickly to a high value because of the intense pumping level. This results in a high loop gain and a high-intensity standing wave in the optical cavity. This quickly depletes the population inversion for that particular wavelength, and lasing stops. Thus, the laser switches itself off momentarily by using up all of its gain. This process is repeated many times for each of the modes of the laser cavity. Because solid state lasers have relatively broad fluorescent line width, there are usually a large number of modes in the output. The result is output pulses that are composed of many small spikes overlapping one another.

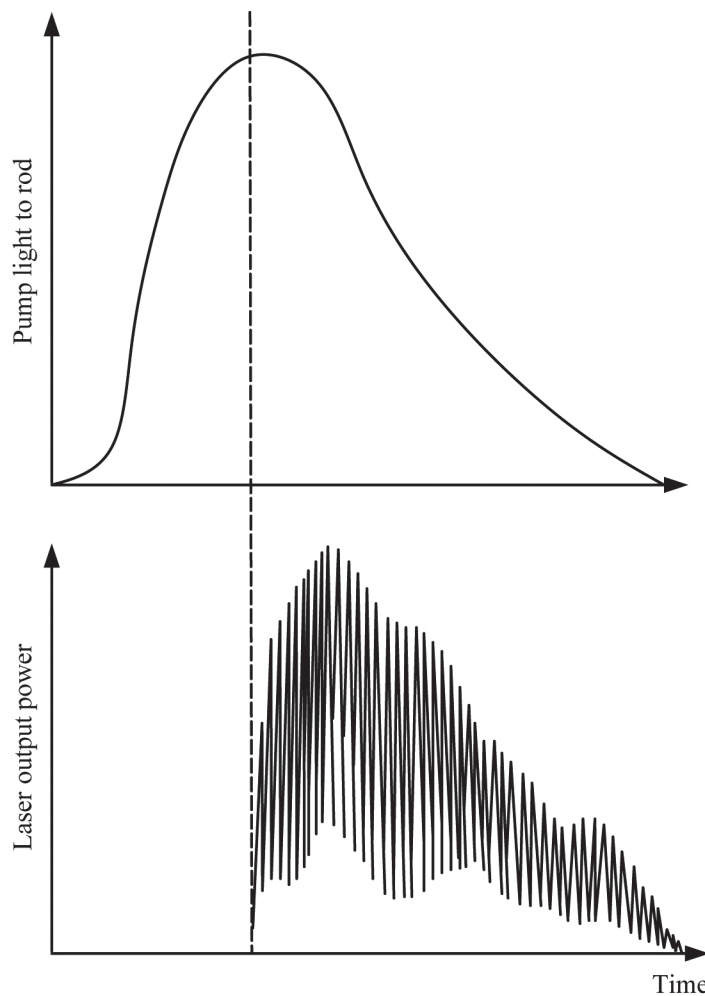

Figure 8-9 *Output of typical pulsed Nd:YAG laser compared with input pump light as a function of time*

Because of the spiking in the output, the peak power of a pulsed Nd:YAG laser tends to be difficult to determine and tends to vary from shot to shot, although pulse energy and overall pulse duration may remain fairly constant. For these reasons, specifications of pulsed solid state lasers usually do not include the maximum output power. Instead, pulse energy and pulse duration are specified. Peak output power may be approximated by dividing the energy of the output pulse by pulse duration. Commercial normal pulse (non-Q-switched) Nd:YAG lasers are typically more consistent in their output characteristics from pulse to pulse. Pulse duration available from pulsed non-Q-switched Nd:YAG lasers varies from as short as 200 μs to as long as 20 ms. The usual pulse duration is about 1–2 ms.

Shorter-duration pulses are produced by Q-switching to generate output pulses with durations of 10 ns. Typical commercial Q-switched solid state lasers have pulse durations in the nanosecond range and peak powers of megawatts rather than the kilowatts common in normal pulsed lasers. Also, the Q-switched pulse is so fast that it does not have the spiking illustrated in Figure 8-9.

The output beam of a pulsed Nd:YAG laser is usually a TEM_{00} beam with a diameter equal to the rod diameter. The beam profile is generally flattened on top rather than a true Gaussian beam shape. Because the laser aperture is usually fairly large, the divergence angle of the output

beam is small. Typical values are a few tenths of a milliradian. Total output energy of a pulsed Nd:YAG laser may vary from a few millijoules up to 100 J.

Nd:YAG Laser Applications

The Nd:YAG laser is by far the most popular pulsed solid state laser. Small versions are widely used in many military applications, including range finders and target designators. These are designed for short pulse durations and usually employ Q-switches for pulse-duration control. They usually use a single linear flashlamp and a gold- or chromium-coated elliptical pumping cavity. Cooling may be by forced air or by a closed liquid cooling system with a liquid-to-air heat exchanger and a fan. Such systems are capable of only a fraction of a joule per pulse.

Larger pulsed Nd:YAG lasers are the most common solid state lasers for materials-processing applications; they produce pulse energies of up to tens of joules. Their applications include marking, hole drilling, scribing, and laser welding. The pumping scheme of such a laser usually includes a double elliptical pumping cavity with a gold or chromium coating and two linear flashlamps. The pulse repetition rate varies from single-shot to as high as 100 pulses per second in some systems. Pulse duration is also adjustable by means of a variable pulse-forming network. Pulse duration can be varied from 0.5 ms to as long as 8.0 ms. The average power of such lasers is in the range of 100 to 400 W.

Nd:YAG is chosen for most materials processing applications because of the high pulse repetition rates available. Power supplies of pulsed Nd:YAG laser used in machining processes are designed to produce a maximum average power from the system. At low pulse repetition rates higher pulse energies are available. At higher pulse repetition rates, the same average power is available, but the energy per pulse is lower. One system can produce 20 pulses per second with 20 J per pulse, or 200 pulses per second with 2 J per pulse.

In such high-pulse-rate systems, the lamps are often “kept alive” to increase lamp lifetime. The greatest strain on the lamps occurs when the lamp is ignited. In a keep-alive or simmering system, a current of about 2 amps flows through the lamps continuously during laser operation. This maintains a discharge in the lamp and eliminates the requirement of a high-voltage trigger pulse for each laser pulse, thus decreasing the resultant lamp shock.

Continuously-pumped repetitively-Q-switched Nd:YAG lasers are often used when relatively low energy pulses with short duration (nanoseconds) are needed. Such requirements arise for applications such as marking. Commercial models of these lasers provide tens to hundreds of millijoules per pulse at pulse repetition rates of tens of kHz. Frequency multiplication techniques give outputs at 532, 355, and 266 nm.

One more interesting application of relatively low-power pulsed Nd:YAG lasers is in the area of medicine. These lasers are often used in tattoo and hair-removal procedures.

For more details on how lasers are used in materials-processing and medicine go to The National Center for Optics and Photonics Education (OP-TEC) website (www.op-tec.org) and download copies of the Photonics-Enabled Technologies (PET) series publications entitled *Laser Welding and Surface Treatment* and *Laser Material Removal: Drilling, Cutting, and Marking*. Other PET series modules that are related to materials-processing include *Lasers in Testing and Measurement: Alignment, Profiling, and Position Sensing* and *Lasers in Testing and Measurement: Interferometric Methods and Nondestructive Testing*. For medical

applications, download the modules entitled *Lasers in Medicine and Surgery*, *Therapeutic Applications of Lasers*, and *Diagnostic Applications of Lasers*.

Summary

A lamp-pumped CW Nd:YAG laser consists of a solid laser rod designed and mounted for high cooling efficiency, a continuous optical pumping lamp with a suitable power supply, a pumping cavity for focusing the pump lamp light into the rod, a low-loss optical cavity, and a cooling system for removal of waste heat energy. Pumping with laser diodes provides substantially higher output efficiency and is now widely used. Acousto-optical Q-switches and frequency doublers may also be included in CW Nd:YAG laser systems.

A most critical subsystem of the laser is the cooling system. Without adequate cooling, overheating would quickly destroy the laser seals, pumping cavity, and lamps, as well as the rod itself. Lasing in Nd:YAG is most efficient when the temperature is lowest. Thus, cooling systems are designed to produce the lowest practical system-operating temperature.

Pulsed solid state lasers are widely used for several applications. The most important of these are range-finding, materials-processing such as drilling and welding and medical procedures.

Safety Considerations

Pulsed solid state lasers, including Nd:YAG, present safety hazards that are among the most severe of any lasers. Peak output powers are so high that direct viewing of the beam or its reflections is an eye hazard even at great distances. The diffuse reflection of the beam from a roughened surface may also present a serious eye hazard. Such reflections are not focused to a small spot on the retina, but peak irradiance is so high that the damage threshold of the retina may be exceeded. Thus, viewing the diffuse reflection of the beam from a pulsed solid state laser is usually hazardous. Safety goggles should always be worn by everyone present when such lasers are operated.

Safety goggles for pulsed solid state lasers are designed to protect against direct exposure to the laser beam. Always check with your Laser Safety Officer (LSO) for the proper safety goggles to use with your Nd:YAG laser system. These lasers are especially dangerous because their output wavelength is transmitted through the eye and focused onto the retina, but the output cannot be seen because it is infrared light. Thus, there is no aversion response for protection as is the case with visible lasers. Because Nd:YAG lasers can emit ultra-short pulse widths in the pico $\{10^{-12}\}$ and femto $\{10^{-15}\}$ s range, ordinary protective goggles for Nd:YAG lasers may not be safe. When working with these ultra-short pulse lasers, make sure your goggles will provide adequate protection. The reason for this concern is that the filter material of some Nd:YAG laser goggles may not protect the eye from ultra-short pulses in the pico and femto range. Nd:YAG lasers are almost always Class 4 laser systems. As discussed previously these lasers need standard operating procedures (SOP) and administrative/engineering controls.

Additionally, output pulses from larger pulsed solid state lasers have sufficient energy to produce minor skin burns, and focused beams can cause deep small-area burns. Thus, skin exposure should be avoided as well.

By far the most serious hazard associated with pulsed solid state lasers has nothing to do with the laser beam. Electrical hazards present in the power supplies of pulsed solid state lasers are the most dangerous of any laser system. Capacitors typically store several kilojoules at voltages of several kilovolts, producing discharge currents of many kiloamps. The power supply also contains other capacitors in the charging and trigger circuits, and larger laser systems are operated with input voltages of 220 V or higher. Although all systems are interlocked to prevent personnel from coming into contact with high voltages, servicing the laser often requires that the interlock system be overridden, and some maintenance procedures must be performed near high-voltage terminals. No one has been seriously injured by a laser beam except for eye damage; however, people have been electrocuted by the power supplies of pulsed solid state lasers.

An associated hazard of many pulsed solid state laser systems is the respiratory hazard presented by material vaporized by the focused laser beam. Such material is always present when the laser is used in a material processing application. The vaporized material forms small particles, typically a micrometer in diameter. If inhaled, these particles can lodge in the lungs. All vaporized material should be exhausted from the work area or trapped in fine filter.

Troubleshooting

Nd:YAG Maintenance & Troubleshooting

The critical components of a Nd:YAG laser are the power supply, cooling system, laser crystal, optical excitation, feedback mirrors and intercavity modulators (for pulsing or second harmonic generation).

Maintenance:

Improper maintenance of any of the optical and electro-optical components can result in sub-standard performance of the laser. Optical components must be kept clean and dust free to prevent damage, deterioration and/or poor reflection. Alignment of the cavity reflectors and positioning of the intercavity modulators is also important.

The laser rod is optically pumped, using either arc lamps or laser diodes (for continuous pumping) or flashlamps for pulse pumping. Arc lamps and flashlamps can deteriorate after extended use. They also have a reflector housing around them to direct their radiation into the laser rod. The reflectivity of the housing can deteriorate from contamination or extended use, reducing the efficiency of the pumping mechanism. Efficiency of optical pumping from laser diodes can be reduced due to improper positioning (or moving) of the diodes on the laser rod, as well as deterioration of the diode efficiency due to overheating, too much pumping current, electrical “spiking” from the power supply and extended use.

Troubleshooting:

Four types of malfunctions can occur

1. Loss of output power, due to:
 - a) Mirror alignment and cleanliness issues (maintenance problems)
 - b) Defective current regulator in power supply
 - c) Defects in the Nd:YAG crystal (requires replacement)
2. Mode changes in output beam, due to:
 - a) Mirror alignment and cleanliness issues
 - b) Defective or dirty crystal rod
3. Instability of laser output power, due to:
 - a) Defect or improper settings on the current regulator
 - b) Improper cooling system operation, due to low level of internal coolant water
 - c) Defective or dirty crystal rod
4. No output laser beam.
 - a) Optical cavity misalignment
 - b) Defective pumping lamp or laser diode

Laboratory

Laboratory 2-8

Measurement of CW and Pulsed Output from a Nd:YAG Laser

Purpose

After completing this laboratory, you should be able to:

- Measure the output characteristics of CW and pulsed Nd:YAG laser systems. Measurements will include:
 - Power (W)
 - Wavelength (λ)
 - Mode (TEM)
 - Beam diameter at 2.54 cm from beam exit
 - Divergence (Θ , mradians)
 - Power stability using statistical analysis
 - E (mJ)
 - P_{avg} (W)
 - P_{peak} (W)
 - Pulse Duration/Width (s)
 - Pulse Repetition Rate (PRR, Hz)
 - Pulse Repetition Time (s)
- Operate all equipment using the safety precautions and procedures specified in their user manuals.
- Devise experimental procedures to accomplish the objectives of this laboratory.
- Develop a lab report that contains the following information:
 - List of all equipment used.
 - Detail of the procedures followed.
 - All equations with explanation and calculations required.
 - Schematic of the completed lab setup, including dimensions and labels.
 - Data of all pertinent laser parameters measured.
 - Graphs/photos/drawings, etc., of data/procedure results.

- Comparison/analysis of measured values to manufacturer's specifications

Equipment

1. Nd:YAG laser with CW and pulsed capabilities
2. Laser safety goggles for appropriate wavelength and OD
3. Beam analyzer/profiler
4. Optical power measuring system (OPMS)
 - a) Relevant detector
 - b) Relevant meter
5. Various support components, tools, etc. (See equipment list for *Fundamentals of Light and Lasers* course.)
6. Beam dump/block
7. IR viewing card/scope
8. Laser mode burn paper (Zap It)
9. Microscope slide or wedge beamsplitter or attenuator
10. Neutral density filter
11. Fast photodiode
12. Digital oscilloscope

Pre-Lab Familiarization

This laboratory will require students to set up, operate, and characterize a Nd:YAG laser. Primary directions for performing these tasks will come from the user manual that accompanies the laser. Before beginning this laboratory, students should familiarize themselves with their laser's user manual.

Procedures

Turning on the laser system

1. Before turning the Nd:YAG laser on, carefully mount, align, and position it so it is level and parallel to the optical table top and securely mounted.
2. The optical axis of the laser beam should be parallel to the optical table top/breadboard at all times. This includes those times when the beam is reflected or otherwise changed.
3. Set the height of beam's optical axis so that it interacts with all mounted components and equipment that the laboratory requires.
4. Place a laser beam dump (laser beam/heat containment) at 0.5 m (or distance of choice) from laser beam exit along its optical axis.
5. Remove any reflective components between the laser beam exit point and beam dump.
6. Everyone who is near the laser while it is operating MUST WEAR safety goggles.

7. Be sure the laser beam shutter is closed. Then turn on the laser and allow it to warm up, according to the user manual.
8. Set laser power for continuous wave (CW) operation.

NOTE: We highly recommend that you take each measurement three times and use the average of these three measurements as your final measurement. Include all three measurements and the final average in your data table. This practice increases the efficiency of the measurement process.

Continuous Wave Operation

Power (P_{max}) and Wavelength (λ)

1. Position the optical power reading system's (OPRS) power detector in the optical axis of the laser beam between the laser beam exit point and the beam dump. Closer is usually better.
2. Be sure to read the OPRS user manual to know if the power detector is able to handle the irradiance. Levels of irradiance beyond those specified in the user manual will damage the detector.
3. Tilt the meter head slightly with respect to the incident beam. This will prevent back reflections (if any—it depends on the detector type) from returning to the laser.
4. Open the beam shutter and align the center area of the power detector to the laser beam's optical axis.
5. Use the IR card/viewer to position the beam.
6. Read P_{max} and record its value in Data Table 1.

Data Table 1

Continuous Wave	
Wavelength (λ)	
P_{max} (W)	
Mode (TEM/ M^2)	
Divergence (mradian)	
Power stability using statistical analysis	
Beam diameter (d_1 @ 2.54 cm from beam exit)	
Beam diameter (d_2 @ l_2)	

NOTE: You may need to change the data tables to meet the demands of your data.

7. You will find the wavelength for your laser in the user manual.
8. Record the wavelength (λ) in the Data Table 1.
9. Close the laser beam shutter.

Mode, Beam Diameter, and Divergence Measurements:

1. Measure 2.54 cm (1 in) from the laser beam exit along the beam's optical axis.
2. Mount and place the laser burn paper (Zap It paper) at this position.
3. Open the shutter and operate the laser to create a mode burn pattern on the paper. The goal is to obtain 1 or 2 acceptable mode burn/beam profiles at 2.54 cm (l_1).
 - a) Initially set the laser at its lowest power/repetition rate (power versus time). This may take several attempts.
 - b) Once the mode burns/beam profiles are obtained, close the shutter.
4. Reposition the laser burn paper at any arbitrary distance (l_2) from the 2.54 cm position.
 - a) For the sake of ease, we recommend that this distance (l_2) be evenly divisible by 10—for example, 10 cm, 20 cm, 30 cm, etc.
 - b) Open the shutter and operate the laser to imprint another mode burn/beam pattern on the paper.
 - c) Close the shutter.
5. Measure and record the laser burn-pattern diameters at l_1 and l_2 .
 - a) At both l_1 and l_2 , measure the beam's x- and y-axis diameters.
 - b) The average of the x and y diameters at l_1 and l_2 are the beam diameters d_1 and d_2 , respectively. Record these beam diameters in Table 1.
 - c) Review the burn pattern and identify the mode (TEM) of the laser. Record the mode in Data Table 1.
6. Measure and record the distance (L) between these two locations, l_1 and l_2 .
7. Calculate and record in Data Table 1 the full angle divergence using the following equation:

$$(\theta) = d_2 - d_1 / L$$

Power Stability Measurement

1. Turn on the laser (be sure to use the beam dump) and allow it to warm up so that all temperatures in the system stabilize.

NOTE: The power detector is a thermal detector and so responds slowly to changes in radiation level. Read its user manual to find information related to its responsivity.

2. Align OPRS's detector in the laser beam's optical axis at some arbitrary but close distance.
3. Open the shutter and read and record power data over time.
 - a) Obtain a one-hour minimum of 60 data points. (Industry standard is normally 24 hours.) This may be done manually or with a computer-based system.
 - b) Read and record all data points in Data Table 2.

Data Table 2

Time	Power
1 min	
2 min	
3 min	
.	
.	
.	
60 min	

- c) Using the statistical functions on a calculator, spreadsheet, or statistical program, analyze Data Table 2 and determine the average power and standard deviation. Record these statistical results in Data Table 1.
4. Close the shutter.

Pulsed/Modulated Operation

Average Power

1. Position the optical power reading system's (OPRS's) power detector in the optical axis of the laser beam between the laser beam exit point and the beam dump. Closer is usually better.
2. Set the laser to operate PULSED/MODULATED.
 - a) Open the shutter.
 - b) Select three repetition rates (trials) for the data table depending on the laser and the oscilloscope's capabilities.
 - c) Use the OPRS to measure the average power at each setting. Record these power measurements in Data Table 3.
 - d) Close the shutter.

Data Table 3

Pulsing			
	Trial 1	Trial 2	Trial 3
P_{avg} (W)			
P_{peak} (W)			
PRT (s)			
PRR (s⁻¹)			
E/pulse (mJ)			
τ (ns)			

Pulse Duration: (τ , FWHM, $\Delta t_{1/2}$)

1. Position the laser and beam dump as in previous experiments.
2. Insert a microscope slide or wedge beam splitter into the laser beam path at a 45° angle with respect to the optical axis. The transmitted beam should stop at the beam dump. The first surface reflection of the beam from microscope slide or wedge beam splitter will be measured in this experiment.
3. Turn on the oscilloscope and adjust its settings to display the laser pulse.
4. Set the laser for the lowest energy/pulse duration output. Open the shutter.
5. Use the IR viewer or viewing card to locate the first surface reflection from the microscope slide or beam splitter.
6. Align the center of the photodiode to the reflected beam's optical axis. Use attenuation devices to allow the photodiode to accept the beam power. Overloading the detector will result in erroneous readings.
7. Using the oscilloscope, observe the displayed pulse.
8. Check to be sure that the displayed pulse is the actual laser pulse desired. If the photodiode is saturated, the oscilloscope display will show the peak of the pulse simply "chopped off" as a distorted waveform. If this is the case, place a neutral density filter assembly in front of the photodiode so that the laser pulse is not clipped or distorted.
9. Set the laser to the same three pulse repetition rates you used when you were collecting data to determine average power for Data Table 3. Using the oscilloscope, measure and record in Data Table 3 for each of these pulse repetition rates:
 - a) Pulse repetition rate (PRR)
 - b) Pulse repetition time (PRT)
 - c) Full width at half maximum (FWHM or τ or $\Delta t_{1/2}$)
10. Close the shutter and turn off the laser. Secure lasers and laboratory according to departmental procedures.
11. Calculate and record in Data Table 3:
 - a) Energy per pulse (E, mJ): $E = P_{\text{avg}}/\text{PRR}$
Peak Power (P_{peak} , W): $P_{\text{peak}} = E/\tau$

WORKPLACE SCENARIO

Here is your opportunity to use the concepts you have learned in this module to solve an actual problem that could arise in a photonics company. Your instructor will provide directions for developing a solution.

Selecting a Nd:YAG Laser for Dicing Silicon Wafers

Scenario

Your organization manufactures integrated circuits. Though lasers are used in many operations, a laser is not presently being used in the wafer dicing operation. The wafers manufactured by your company are silicon and have a thickness of 50 microns. To meet production requirements, the minimum speed of the wafer dicing operation is 1000 mm/s.

You have been asked to research the possibility of using a Q-switched Nd:YAG laser to dice the wafers. You should select at least three lasers from different manufacturers that meet the requirements you determine to be necessary.

The output of your research will be a memo to the purchasing manager, describing requirements of the dicing operation, the specifications of the laser required for the dicing operation, and the lasers you have selected that will meet the specifications. The memo should also briefly describe each laser, including details of pumping sources. This memo will provide the purchasing manager the necessary information to solicit bids from the laser manufacturers.

Additional Information

Information needed to solve this problem can be found from the following sources:

1. Explanation of the Q-switched laser operational parameters and their effect on the output can be found in *Module 2-1: Q-Switching, Mode Locking and Frequency Doubling*.
2. Module 2-8: *Nd:YAG Lasers and Their Applications*
3. Laser dicing application paper http://assets.newport.com/webDocuments-EN/images/Si_Wafer_Laser_Dicing_SP.pdf as a start.
4. Other web resource references

Problem and Tasking

1. Given the thickness and speed dicing requirements, research and determine the values (maximum, minimum, and/or ranges) required for the operation of the key laser parameters. Suggested parameters to consider include:
 - a) Wavelength (1.06 μm or 0.53 μm SHG Nd:YAG)
 - b) Peak Power
 - c) Average Power
 - d) Pulse Rate
 - e) Repetition Rate

- f) Irradiance
- 2. Prepare a table showing the values of the key laser parameters required for the dicing operation.
- 3. Based on the determined values of the key laser parameters, research and locate at least three lasers from different laser manufacturers that possess the values of the key laser parameters required.
- 4. Create a memo to the Purchasing Manager describing your findings. Include the following:
 - a) Describe the need of your organization for this equipment.
 - b) Indicate the budget allocation required for the equipment.
 - c) Request a solicitation for bids.
 - d) Requirements of the dicing operation.
 - e) Performance specifications (desired parameters) for the laser equipment.
 - f) Suggest at least three laser manufacturer to bid to supply the laser and give model # of the laser you think would be best for dicing application. Provide information on each manufacturer, including web site and contact information.
 - g) An attachment showing the research you performed and the rationale for the requirements.

PROBLEM EXERCISES AND QUESTIONS

1. Define solid state lasers.
2. Name at least four solid state lasers.
3. Draw a simplified energy-level diagram of Nd:YAG.
4. Name and describe the four subsystems of CW Nd:YAG lasers.
5. Explain the term “operating efficiency.”
6. Draw and label a diagram showing power flow in an Nd:YAG laser. The diagram must show power flow and all losses, from the entry of the electrical power into the laser power supply until the emergence of the output laser beam. All significant losses must be listed and the power losses explained.
7. A CW Nd:YAG laser has an input power of 2500 W of electrical input power and uses a krypton arc lamp. Output power of the laser is 4 W. The cooling water must have a temperature rise less than 4°C in passing over the rod. Make appropriate calculations to determine the water flow rate and total temperature rise in the cooling water after cooling the laser rod plus the lamp and cavity. You may make the same assumptions as in the text for various efficiencies.
8. Why are xenon flashlamps used with pulsed neodymium lasers, even though krypton provides better spectral matching? How may the spectral match of xenon to neodymium be improved?
9. How is the transmission of the output coupler chosen for pulsed solid state lasers?
10. Explain methods of rod and lamp cooling for pulsed solid state lasers. The explanation should include a description of the two configurations used to deliver coolant to the rod and lamps in liquid-cooled systems.
11. Explain the importance of coolant temperature in liquid-cooled pulsed solid state lasers and the effects on laser performance if the temperature is too high or too low.
12. Draw and label a diagram of the output pulse of a typical pulsed solid state laser, and explain the origin of spiking in the laser output.
13. Discuss eye hazards and electrical hazards present in pulsed solid state lasers.

REFERENCE

- Gregory, Daniel J. *Solid state Lasers for the Laser Enthusiast: A Guide for the Design and Construction of a High Peak Power Solid state Laser System*. Orlando, FL: American Lasertechnik, 2003.
- Koechner, Walter. Chapters 2 and 6 in *Solid state Laser Engineering*. New York: Springer-Verlag, 2006.
- O'Shea, Donald C., Russell W. Callen, and William T. Rhodes. Chapters 3 and 6 in *Introduction to Lasers and Their Applications*. Reading, MA: Addison-Wesley, 1977.
- Quantel USA. Nd:YAG Lasers: Standing the Test of Time. *The Photonics Handbook*. Pittsfield, MA: Laurin Publishing, 2008.
<http://photonics.com/edu/Handbook.aspx?AID=25042> (accessed January 9, 2014).
- Ready, John F., ed. Lasers for Materials Processing. Chapter 2 in *Handbook of Laser Materials Processing*. Orlando, FL: Laser Institute of America, 2001.
- Silfvast, William T. *Lasers*. Chapter 11 in *Handbook of Optics*, ed. Michael Bass. New York: McGraw-Hill, 1995.
- Specifications Guide. *Laser Focus World 2013 Buyers Guide*. Nashua, NH: PennWell Corporation, 2013: 172.

INDEX OF TERMS

A

Active laser material, 3, 4
Applications, 19
Arc-lamp (see continuous pump), 5-6, 13, 14

C

Continuous wave lasers, 7
Continuous-pump, 3, 5-6, 13
Cooling system, 6, 8-11, 16

E

Energy levels, 5, 6
Energy losses, 7-8
Equilibrium conditions, 7

F

Flashlamps, 15
Frequency doubling, 13

L

Laser cavity, 6, 15
Laser rod, 14

O

Operating efficiency, 7, 11, 12
Optical pumping system, 15
Output characteristics, 17

P

Pulse pumped lasers, 13, 17

Q

Q-switched lasers, 16

S

Safety considerations, 21
Semiconductor diode-pumped lasers, 11, 14

T

Troubleshooting, 22

W

Wall-plug efficiency (see operating efficiency), 7
Wavelengths produced, 5, 12
Workplace scenario, 29

Excimer Lasers and Their Applications

Module 2-9

of

Course 2, *Laser Systems and Applications*
2nd Edition

OPTICS AND PHOTONICS SERIES



© 2016 University of Central Florida

This material was developed by the National Center for Optics and Photonics Education, OP-TEC, and is based upon work supported by the National Science Foundation under Grant No. 1144377 and completed under Grant No. 1303732. Any opinions, findings, and conclusions or recommendations expressed in this material are those of the author(s) and do not necessarily reflect the views of the National Science Foundation.

For more information about the text or OP-TEC, contact:

Dan Hull

PI, Executive Director, OP-TEC

316 Kelly Drive

Waco, TX 76710

(254) 751-9000

hull@op-tec.org

Published and distributed by

OP-TEC

316 Kelly Drive

Waco, TX 76710

254-751-9000

<http://www.op-tec.org/>

ISBN 978-0-9983480-8-7

CONTENTS OF MODULE 2-9

Introduction	1
Prerequisites	2
Objectives	2
Basic Concepts	2
Excimer Laser Concepts.....	2
Excimer Production.....	2
Excimers as Lasing Materials	4
Characteristics of Excimer Lasers.....	6
Problems with Excimer Lasers.....	7
Corrosive Gases.....	7
Site Requirements	7
Applications	8
Microprocessing.....	8
Medical Procedures	8
Photolithography	9
Other Applications	9
Summary	9
Safety Considerations.....	11
Troubleshooting	13
Laboratory	15
Workplace Scenario	19
Problems Exercises and Questions.....	20
References	21
Index of Terms	22

Module 2-9

Excimer Lasers and Their Applications

INTRODUCTION

The word *excimer* is a contraction for *excited dimer*. A *dimer* is a molecule consisting of two identical molecules or atoms. In the earliest excimer laser, the excited dimer that formed the active medium was Xe_2 . As excimer laser development progressed, scientists found that it was actually more effective to use two different molecules as the active medium than it was to use two identical molecules. Typically, these different molecules consisted of some combination of a rare gas (Ar, Kr, or Xe) and a monohalide (F or Cl). When rare-gas atoms and monohalides combine, they form molecules in an excited state called *exciplexes*, which is a contraction for *excited complexes*.

Technically, the lasers presented in this module should be called *exciplex lasers*, but by convention, they are instead referred to as *excimer lasers*. Likewise, the laser community has also adopted the convention of referring to exciplexes as *dimers*. In this module, we will use both these conventions.

For the remainder of this module, the word *excimer* may refer to lasers that have lasing mediums consisting of either excited dimers or excited complexes, and the word *dimer* may refer to molecules consisting of either two identical molecules or two different molecules.

An example of an excited dimer is argon fluoride (ArF), which can be formed by an electrical discharge in a high-pressure mixture of argon and fluorine gas. Because the dimer is in an excited state, it breaks up rapidly, in a matter of nanoseconds. There is no stable ground state, because (as one learns in elementary chemistry) the rare gases, also known as *noble gases*, do not form stable chemical compounds. As ArF dissociates into a free fluorine and argon atom, the atoms drop into energy states that are lower than that of the excited dimer. This difference in energy appears as a photon with a frequency proportional to the energy drop. Typically, this frequency is in the ultraviolet part of the electromagnetic spectrum, making excimer lasers a source of high-power ultraviolet light. As further dissociations occur, enough photons are produced in the active medium to initiate the process of stimulated emission. At this point, the excimer laser begins to generate laser light.

In this module, students will learn the process of excimer formation in the laser medium—in other words, the excitation process. Students will also study the properties of the light that excimer lasers produce and learn how excimer lasers are being used in a variety of high-tech

applications. Students will also operate an excimer laser and measure specific properties of its output.

PREREQUISITES

OP-TEC's *Fundamentals of Light and Lasers Course*

OP-TEC's *Laser Systems and Applications Course, Module 1: Laser Q-Switching, Mode Locking, and Frequency Doubling, Module 2: Laser Output Characteristics and Module 3: Laser Types and Their Applications*

Understanding of high school level trigonometry and algebra concepts, including exponentials and logarithms

OBJECTIVES

Upon completion of this module, the student should be able to:

- Define the terms *excimer*, *dimers*, *exciplexes*, and *complexes*.
- Name the two most important excimer lasers and correctly state their wavelengths.
- Describe the process by which excimer lasers operate.
- Describe the breakup of metastable excimer molecules.
- Describe two methods of producing high-energy electrons for producing excimers.
- Describe problems associated with excimer lasers.
- Describe issues associated with site preparation for use of excimer lasers.
- Describe some applications of excimer lasers.
- Safely operate and measure some of the properties of an excimer laser.

BASIC CONCEPTS

Excimer Laser Concepts

Excimer lasers produce high-power radiation in the ultraviolet region of the spectrum. As explained above, the term *excimer* is derived from the word *dimer*, which by modern convention means a diatomic molecule formed by the union of either two identical or two different atoms.

Excimer Production

If the diatomic molecule is in an excited state, it is called an *excited dimer*, or *excimer*. An excimer is an unstable molecule. Most excimer lasers use molecules that contain an atom of a rare gas (noble gas), such as argon or krypton, and these gases do not form chemical compounds

under normal conditions. However, when energy is added, the noble gases may enter into chemical compounds that have no stable ground state but exist in excited states. The noble gases in these excited molecules can stay bound to other atoms for a brief time, typically in the nanosecond range.

For example, a high-power pulsed electrical discharge may excite a gas mixture that contains krypton and fluorine. This discharge initiates a chain of processes that forms a metastable molecule KrF^* . The asterisk denotes that the molecule is in an excited state. Because KrF^* can only exist in an excited state, it does not have a ground state. By definition, this means that any KrF^* molecules that are formed constitute a population inversion. Equation 1 represents the interaction:

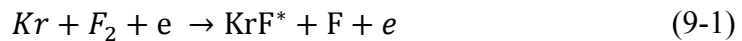

where e represents an electron. The electron on the left side of the reaction is a high-energy electron, and the electron on the right side has substantially less energy. The difference in energy between these two electrons is used to break up the fluorine molecule and to excite the KrF^* molecule. Figure 9-1 illustrates the formation process of an excited krypton fluoride molecule.

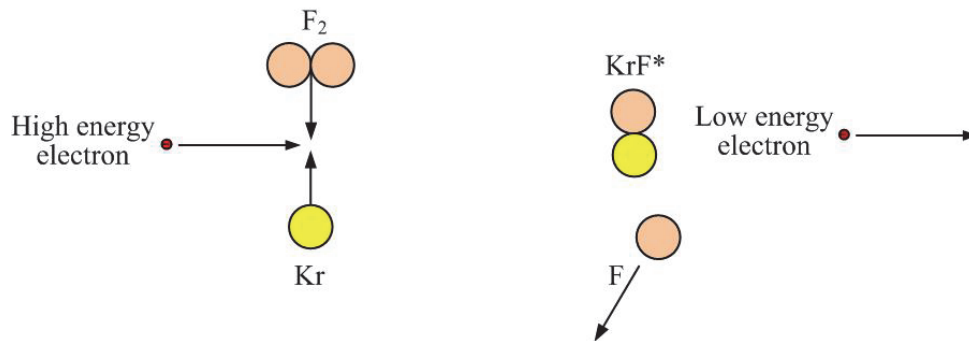

Figure 9-1 Formation of a KrF^* molecule. Left: Original situation of approaching particles before interaction. Right: Situation after the interaction has formed KrF^* .

The excited KrF^* molecule stays bound together for a short time (nanoseconds) and then dissociates according to the reaction:



where $h\nu$ represents a photon with energy corresponding to a wavelength of 248 nm. This disassociation involves the molecule falling to its ground state, in which the krypton and fluorine atoms are not bound to each other. Figure 9-2 represents this breakup. After the disassociation, the krypton and fluorine atoms are no longer bound and act as independent atoms.

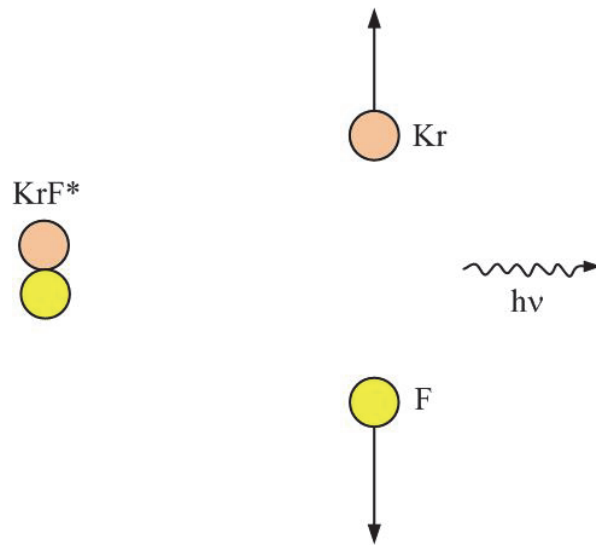

Figure 9-2 Breakup of excited KrF^* molecule. Left: Original KrF^* molecule. Right: Products of breakup of KrF^* molecule.

The emission of the photon (with energy $h\nu$) causes KrF^* to fall to its lowest energy state, which is the condition in which the krypton and fluorine atoms are not bound and repel each other. This repulsion occurs because the krypton and fluorine atoms disassociate as ions with opposite charges. Because this process involves the very short-lived KrF^* , excimer lasers are always pulsed devices, with pulse durations in the nanosecond range.

Excimers as Lasing Materials

The energy-level diagram shown in Figure 9-3 illustrates how excimers can produce laser light. The energy-level diagram is not a diagram of a specific excimer; instead, it shows the general characteristics of any excimer. The atoms are in a bound state only after a high-energy input raises them to an ionized excited state. This bound state is the upper laser level. From there, the molecule returns to the unexcited ground state of the two separated atoms that formed the excimer. A population inversion exists as soon as there is an excited state—that is, as soon as an excimer is formed. This is because an excimer can only exist in an excited state, which means that the population of the lower laser level for the excimer is always zero.

The potential well in Figure 9-3 of the excited state shows the existence of a short-lived stable state—a type of metastable state. The fact that there is no potential well in the ground state shows that there is no bound state of the excimer when it is not excited. Only within the marked area inside the potential well of the excited state can the excimer exist. The abscissa of the graph in Figure 9-3 indicates that this potential well depends on the distance between the atoms that compose the excimer; for an excimer to exist, the distance between the atoms must fall into a specific, narrow range.

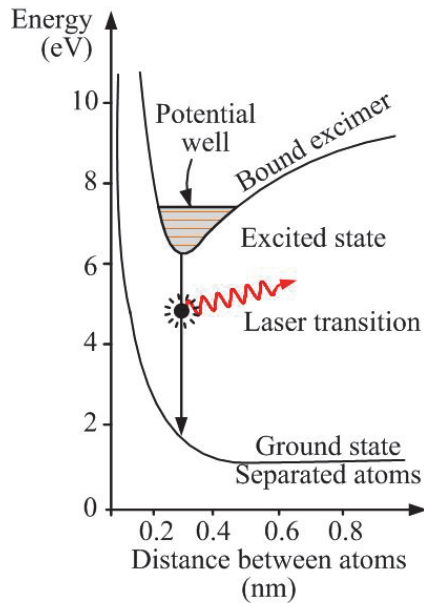

Figure 9-3 Energy level diagram for an excimer

In a laser, excimers are formed by sending a pulsed electrical discharge through a gas mixture that usually contains a noble gas, such as argon or krypton; a halogen, such as fluorine or chlorine; and a carrier gas, such as helium. As the excimers form, the potential well in Figure 9-3 starts to become populated. As excimers disassociate and drop out of this potential well, they release photons with wavelengths that vary according to laser's gas mixture, as shown in Table 9-1.

Table 9-1. Excimer Lasers

Excimer	Wavelength	Relative Output (arbitrary units)
F ₂	157 nm	No data
ArF	193 nm	60
KrF	248 nm	100
XeBr	282 nm	No data
XeCl	308 nm	50
XeF	351 nm	45
KrCl	222 nm	25

Eventually, enough photons are present in the cavity of the laser to cause the onset of stimulated emission. When this happens, photons in the laser cavity stimulate excimers to disassociate and give off photons that are identical to those causing the stimulation. At this point, laser light is being produced at one of the wavelengths shown in Table 9-1.

Table 9-1 lists a number of the significant excimer lasers that have been developed, along with some relative output powers normalized to KrF as 100. Other excimers exist, but those in the table are the most common. Because of the number of their applications, ArF and KrF may be considered the most important. All the entries in the table are dimers (based on the conventional

definition) consisting of a noble gas atom and a halogen atom—except for the F₂ dimer, which has become important in short-wavelength lithography.

Characteristics of Excimer Lasers

Many commercial models of excimer lasers are available. Table 9-2 lists some typical characteristics of commercial excimer lasers. There is some tradeoff between pulse repetition rate and maximum pulse energy. The highest pulse energies are not available at the highest pulse repetition rates.

Table 9- 2. Typical Output Characteristics of Commercial Excimer Lasers

Pulse Energy	up to 1000 mJ
Pulse Repetition Rate	10-2000 Hz
Average Power	Up to 150 W
Beam Divergence	1 – 3 mradian
Pulse Duration	10-30 ns
Efficiency	1-3%

Also, the beam profile is usually rectangular. A typical beam may have dimensions up to 35 mm. The rectangular profile makes it more difficult to focus the beam to a very small spot, compared with a beam whose cross section is circular.

The high-energy electrons necessary for the creation of the excited upper laser state may be supplied in two different ways.

- The first method is a pulsed electrical discharge. This is the method common in commercially available devices. Figure 9-4 shows a schematic diagram of a pulse-discharged device. Parallel electrodes are inside the laser tube that contains the gas mixture. A high-voltage (multikilovolt) pulse is discharged between the electrodes. This produces a transient burst of high-energy electrons that produce excimers such as KrF* in a reaction such as the one given by Equation 9-1. The excimer molecules dissociate in accordance with a reaction like the one described by Equation 9-2 and in doing so, produce ultraviolet light. To make the discharge homogeneous, many such lasers employ a pre-ionization pulse.

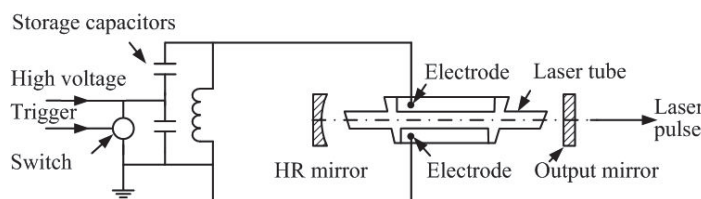

Figure 9-4 Simplified schematic diagram of an excimer laser

- The second method uses electron beam devices. An electron beam is a stream of electrons that is generated in several different ways and then deflected, focused, and

energized by electric and magnetic fields. Electron beams are used in research and for applications such as welding. Electron-beam devices are large and expensive. Moderate pricing is important for commercially available excimer lasers, so these lasers do not use electron beams. But electron beams have been used in excimer laser research sponsored by governmental agencies. One key advantage in using electron-beam devices is that they are scalable to much higher pulse energies than the commercial models: some have demonstrated kilojoule energy pulses.

Problems with Excimer Lasers

Corrosive Gases

The corrosiveness of the gas mixture, especially fluorine, has been a problem for excimer lasers. Fluorine's corrosiveness can reduce the lifetimes of the electrodes. The first excimer lasers had very short lifetimes, largely because of ablation of material from the electrodes. Also, the high-peak electrical current quickly damaged the thyatrons used as electrical switches. Fluorine is also a potential hazard for the operator; if the tube were to break, the operator would run the risk of serious skin and respiratory problems.

Another problem with excimer lasers is deterioration of the gas mixture. Interaction of the halogen with the tube walls removes some of the halogen and reduces the laser output. A solution to this problem is connecting gas bottles to the laser system that replenish the gas fill when the laser performance diminishes.

In recent years, engineering advances have led to the development of materials with high corrosion resistance, as well as solid state high-voltage switches. These advances have reduced the problems associated with excimer lasers. In addition, the use of total enclosures for the laser has diminished the hazard to operators. These enclosures are equipped with high-capacity fans to exhaust any released gases to a safe place. As a result, the safety of the people who operate excimer lasers has improved substantially. Excimer lasers are now used by trained medical personnel for applications such as correction of vision problems.

The manufacturers of excimer lasers now claim that the greatest limitation to the lifetime of an excimer laser is damage to its UV optics. These optics are damaged by the high intensity of the UV radiation that passes through them. However, with advances in UV protection for these optics, manufacturers now claim lifetimes of billions of pulses for their excimer lasers.

Site Requirements

On-site preparation is required before an excimer laser can be installed. A technician may be needed to perform some of the site preparation.

Gas Supply

The somewhat unusual combination of gases used in excimer lasers requires a specialized gas supply. The active medium of an excimer laser—a mixture of a noble gas (argon, krypton, or xenon), a halogen (often fluorine), and a buffer gas (often helium)—is usually supplied premixed. In addition, another gas (usually nitrogen) is needed as a purge for the beam path for excimer lasers operating at wavelengths of 157 or 193 nm. This is necessary in order to avoid absorption of the deep-ultraviolet laser light. Finally, a flush gas (helium) is also necessary to clean out the cavity when it needs to be serviced.

The laser system must be connected to an exhaust ventilation system. Commercial excimer lasers typically have their own exhaust ventilation systems. The exhaust system must be vented to a safe place where no people will be exposed to it. In some cases, this may require modification to the building.

Cooling

Excimer lasers have efficiencies less than ten percent. The rest of the input electrical energy is dissipated as heat. Some lower-power excimer lasers are air cooled. But at higher powers, excimer lasers need water cooling.

Power Supply

Different models of excimer lasers require different electrical power supplies. The requirements are typically not unusual. Some commercial models operate with 115 or 230 V single-phase input or with 208 V three-phase input.

Applications

Excimer lasers provide an intense source of ultraviolet light, which makes them valuable in numerous fields of application.

Microprocessing

The energy of the photons from some of the excimer lasers is high enough to break chemical bonds. This leads to a situation in which the beam strikes a target and the chemical bonds in the target material are broken. The atoms of the material then disintegrate into the surrounding air or vacuum. This process is called ablation. It is different from the conventional vaporization of materials, in which light is absorbed, heats the material, and vaporizes it. In ablation, there is essentially no heating or damage to the surrounding material. This leads to the ability to remove very thin and controlled amounts of material from a surface without damaging the rest of the material. Thus, excimer lasers are used for precision material removal.

The process of machining by ablation has been called *cold microprocessing*. Cold microprocessing offers the advantage of rapid material removal without any heat-affected zone. As an example, cold microprocessing is commonly used to drill a matrix of closely spaced small holes to create inkjet nozzles for printers. The use of excimer lasers for this application has substantially reduced the costs of manufacturing inkjet nozzles.

Medical Procedures

Excimer laser light is well absorbed by organic materials, including biological materials. These considerations make excimer lasers well suited for precision surgeries, especially eye surgery. Excimer lasers have been used for LASIK surgery, which reshapes the cornea to improve vision. They have also been used to treat dermatological conditions. This use takes advantage of the ability to ablate controlled amounts of material without affecting surrounding material. One example is treatment of psoriasis, a skin disease characterized by scaly, red, itchy patches. Psoriasis has been treated with XeCl excimer lasers operating at 308 nm. Excimer lasers are still fairly large, though, which inhibits some possible medical uses.

Photolithography

In industry, excimer lasers have been used for high-resolution photolithography, which is used to manufacture microelectronic chips. Originally, mercury lamps with outputs near 400 nm were used for this purpose. But mercury lamps decreased in popularity as engineers sought to reduce microelectronics feature sizes.

The short wavelength of excimer lasers offers a means of reducing feature sizes (and increasing the packing density of components on a chip) in lithographic processes. The shorter the wavelength, the higher the resolution light can obtain. We know that the wavelength of light is the minimum diameter of the spot to which light can be focused. Likewise, the area of this spot is estimated as inversely proportional to the square of the wavelength. Thus, as the wavelength decreases, the packing density increases as the inverse square of the wavelength. The short wavelengths of excimer lasers allow them to be focused to very fine spots, which makes it possible to reduce the sizes of features in microelectronic devices. The use of ArF and KrF lasers (wavelengths 193 and 248 nm, respectively) allowed the microelectronics industry to substantially reduce the feature size and increase packing density for microelectronic chips. The ArF and KrF excimer lasers were the standard light sources for many years in microelectronic photolithography. More recently, photolithographers have been using F₂ excimer lasers. This has allowed the feature size in microelectronics to be reduced to 22 nm, and further reductions in feature size are expected. Excimer lasers now have a viable future due to this application and advances that have made them safer and easier to service.

Other Applications

Excimer lasers have become valuable tools in today's high-technology workplace.

- Excimer lasers have been used to pump tunable dye lasers, especially dye lasers in the blue and green portions of the visible spectrum.
- Manufacturers use excimer laser annealing to produce the low-temperature polysilicon used in flat-panel displays. Optics are used to shape an XeCl 308 nm excimer laser beam into a line profile. To anneal the silicon-coated substrate, manufacturers scan the substrate through the laser beam.
- Other industrial applications include marking of glass products, laser doping of phosphorous silicate glass solar cells, and laser chemical vapor deposition of thin films on wafers.

If you require more information or greater detail on the applications presented in this module go to the OP-TEC website, www.op-tec.org, and review the modules in the Photonics-Enabled Technologies (PET) series. These modules cover a broad range of photonics applications in the following technology areas: manufacturing, biomedicine, forensic science and homeland security, environmental monitoring, optoelectronics, data storage and imaging, fiber-optic communication, and holography. You may request a download copy of a PET module through the OP-TEC website.

Summary

This module has explained the excitation and breakup of excimers. It has presented the operating details of excimer lasers, characterized the output of these lasers, and discussed some

of the problems associated with working with corrosive gases such as fluorine. It has described the site requirements that excimer lasers need, and it has presented applications for excimer lasers, the most important of which is photolithography for microelectronic fabrication.

In describing the operating details of excimer lasers, the module introduced several technical terms and concepts that are unique to this type of laser. You learned that *excimer* is a contraction for *excited dimer* and that a dimer is a molecule made up of two atoms. Strictly speaking, a dimer is made up of two identical atoms, but in laser technology, the term *dimer* also applies to molecules made up of two different atoms, such as KrF. You also learned the process by which excimers produce laser light:

- An excimer can be formed by an electrical discharge in a high-pressure mixture of noble gases and halogens.
- Excimers can only exist in an excited state and break up rapidly, in a matter of nanoseconds.
- Excimers have no stable ground state, but in their excited state, they have a potential well that acts as a metastable state.
- When this metastable state decays, the bonds of the atoms composing the excimer break. In this disassociation process, the energy of excitation is converted into the emission of ultraviolet-wavelength photons.
- When enough photons are produced in the laser cavity, stimulated emission begins, and laser light is produced.

SAFETY CONSIDERATIONS

Excimer lasers emit wavelengths from 157 nm to 351 nm. These wavelengths fall in the UVA, UVB, and UVC spectral regions. Radiation in the UVB and UVC range (100nm to 315nm) is a threat to the cornea of the eye, and UVA radiation (315 nm to 400 nm) is a threat to the lens of the eye. These eye injuries could be both thermal and photochemical. A thermal injury is similar to a welder flash, in which the eye is exposed to a surge of UV light. In fact, the thermal Maximum Permissible Exposures (MPEs) for a wavelength of 308 nm are the same as those used for middle and far-infrared wavelengths for similar exposure times. Example 1 demonstrates how both thermal and photochemical MPEs are calculated and used.

Example 1

A medical xenon chloride laser emits 200 ns pulses at a wavelength of 308 nm. What are the thermal and photochemical MPEs for a 10 s exposure and a pulse repetition rate (PRR) of 200 Hz.

Solution:

The MPE for ultraviolet lasers is based on a dual limit of photochemical effects and thermal effects. The MPE for 308nm is $40 \text{ mJ}\cdot\text{cm}^{-2}$ for exposure durations from 1 ns to 3×10^4 s. This MPE is based on photochemical effects on the eye or skin. The MPE limit for thermal effects is defined as $0.56 t^{0.25}$ (where t is the exposure time), and like the MPE for photochemical effects, it must not be exceeded. In fact, this thermal MPE is used for middle and far infrared wavelengths for exposures lasting more than a few nanoseconds. (See **ANSI Z-136.1**.)

For thermal effects, the MPE is $0.56 t^{0.25} \text{ J}\cdot\text{cm}^{-2}$, where t is the exposure time, which is 10 s.

$$\text{Thermal MPE} = 0.56 \times (10)^{0.25} \text{ J}\cdot\text{cm}^{-2} = 0.56 \times 1.78 \text{ J}\cdot\text{cm}^{-2} = 1.0 \text{ J}\cdot\text{cm}^{-2}$$

During a 10 s exposure, a person could be exposed to $200 \text{ pulses/s} \times 10 \text{ s} = 2000$ pulses. The thermal MPE for each pulse is then

$$1.0 \text{ J}\cdot\text{cm}^{-2} / 2000 = 0.5 \text{ mJ}\cdot\text{cm}^{-2}$$

The MPE based on photochemical effects for an accumulated exposure over a 10s duration is $40 \text{ mJ}\cdot\text{cm}^{-2}$. Therefore, the MPE per pulse based on photochemical effects is:

$$\text{Photochemical MPE per pulse} = 40 \text{ mJ}\cdot\text{cm}^{-2} / 2000 = 20 \text{ uJ}\cdot\text{cm}^{-2}$$

Since the photochemical MPE is much less than the thermal MPE, the MPE for a single pulse for this laser is the more conservative number, $20 \text{ uJ}\cdot\text{cm}^{-2}$.

$$\text{MPE per pulse} = 20 \text{ uJ}\cdot\text{cm}^{-2}$$

Excimer lasers use halogen gases, which are dangerous due to their corrosive nature. Laboratories usually incorporate gas sniffers to alert technicians to any gas leakages. These lasers are Class 4 systems and need especially sound engineering and administrative controls. Make sure your goggles have the proper optical density (OD) for the excimer laser wavelength used. As always, consult your laser safety officer (LSO) if you have any questions.

TROUBLESHOOTING

Excimer Laser Maintenance & Troubleshooting

Maintenance:

The maintenance of systems containing excimer lasers primarily involves keeping the optics clean, maintaining the correct laser gas pressure, and properly arranging the work space.

Troubleshooting:

Excimer lasers are self-contained and should require very little repair from photonics systems technicians (PSTs) in user organizations.

Most of the problems that can be corrected at the user site relate to one of three issues:

- Power supply failure
- Leaks in the laser gas system
- Dirty or damaged external optics.

If the system malfunctions it is advisable to contact the manufacturer, who will either tell you how to correct the problem, send a replaceable module, call a field service technician, or request that you return the equipment for repair. Before contacting the manufacturer, make the following measurements:

- Power, energy, and temporal characteristics
 - Peak pulse and average power of the output beam
 - Pulse energy (most likely to show a problem)
 - Pulse duration
 - Pulse shape (rise time and fall time)

If any of these characteristics differ from specifications, the PST should look for a problem in the electrical system.

- Spatial characteristics of the output beam
 - Beam profile
 - Beam divergence

These malfunctions may be due to damaged or dirty optics, either in the laser or in the beam delivery system.

- Gas pressure in the laser tube
 - If the equipment contains a meter or digital reading that indicates the gas pressure, note the pressure and compare it with the manufacturer's specifications.
 - The gas in an excimer laser tube contains a chloride or fluoride compound. These types of gases are usually toxic and corrosive. These gases are also extremely

harmful to breathe. Adequate ventilation should be available in the working area. Technicians without extensive knowledge or experience in the construction of excimer lasers should not attempt to open or repair these devices.

LABORATORY

Laboratory 2-9

Measurement of Output from an Excimer Laser

Purpose

After completing this laboratory, you should be able to:

- Safely operate an excimer laser in a designated area.
- Safely examine and record operational information from an excimer laser.
- Use the proper techniques to set up and operate an excimer laser, collect data about the laser, and analyze the data.
- Understand the basic hazards associated with excimer lasers and the proper storage of premixed gases.

Equipment

1. Excimer laser
2. Laser safety goggles for the appropriate wavelength and with the proper optical density
3. Photodetector (Newport 818-BB-22)
4. Energy meter (Coherent LabMax TO)
5. Energy detector (Coherent PM30-30 W thermopile)
6. Digital O-scope
7. Optical bench with various support components (from *Fundamentals of Light and Lasers* course)
8. Beam dump/block

Pre-Lab Familiarization

This laboratory will require students to set up, operate, and characterize an excimer laser. Primary directions for performing these tasks will come from the user manual that accompanies the laser. Before beginning this laboratory, students should familiarize themselves with their laser's user manual. Students should also review the user manual for any measuring equipment used in this laboratory and make certain that they understand the maximum input that this equipment can safely and without damage monitor.

Safety Precautions

Before starting this laboratory, discuss with your instructor all excimer laser safety precautions related to the following hazards:

1. High Voltage
2. Harmful/corrosive gases under high pressure
3. Ultraviolet radiation
4. Electromagnetic radiation

In operating an excimer laser, you must follow national and local safety guidelines for Class 4 lasers. You must also follow safety considerations for the use and handling of fluorine and/or chlorine gas, including wearing Personal Protective Equipment (PPE) such as gloves, safety glasses, and gas masks. A current Material Safety Data Sheet (MSDS) describing the premixed gases used in your excimer laser should be readily available in your laser laboratory.

Procedures

Before turning on the laser

1. Ensure that all safety precautions, including signage and safety goggles, are in place before you begin the laboratory.
2. Read and understand the manufacturer's user manual for the excimer laser that you are using in this laboratory. Through the user manual, familiarize yourself with your laser's specifications, operating procedures, and safety considerations. If you don't understand any of these specifications or considerations, consult your lab instructor before you begin the laboratory.
3. Before turning the excimer laser on, carefully mount, align, and position it so that it is level and parallel to the optical table top and securely mounted.
4. The optical axis of the laser beam should be parallel to the optical table top/breadboard at all times. This includes those times when the beam is reflected or otherwise changed.
5. Place a laser beam dump/block approximately .5 m from the laser beam exit along the laser's optical axis.
6. Attach the energy detector to the energy meter and place the detector so that the beam block is between the detector and laser.
7. Set the height of the beam's optical axis so that it interacts with all the mounted components and equipment that the laboratory requires. Be sure that the energy detector is aligned with the optical axis of the laser.
8. Remove any reflective components between the laser beam exit point and beam dump.
9. Everyone who is near the laser while it is operating **MUST WEAR** safety goggles.

Starting the laser and measuring energy

1. Before you turn on the laser, make sure that its output power does not exceed the maximum input energy of the energy detector. When verified, set the laser for a single-pulse mode and turn it on.
2. Remove the beam dump/block. Measure and record the single-pulse energy (E_{sp}).

$$E_{sp} = \underline{\hspace{2cm}}$$

3. Adjust the excimer laser's pulse repetition rate to 5 pulses/s. Measure and record the average energy of these pulses.

$$E_{\text{avg}} = \underline{\hspace{2cm}}$$

4. After you have collected the data for steps 2 and 3, replace the beam block between the laser and the energy meter.

Pulse characteristic measurements

1. Start with the equipment set-up in Step 4 of the previous measurement for E_{sp} and E_{avg} .
2. Attach the photodetector to the oscilloscope.
3. Set the oscilloscope sweep parameters to capture and display the laser's pulsed output.
4. Remove the beam dump/block.
5. Position the photodetector so that it can SAFELY catch the signal reflected from the energy detector. (This should be off axis and 2–3 feet from the reflection. NOTE: You may need to experiment from farther away to prevent damage to the photodetector.)
6. Create an image of the trace on the oscilloscope (i.e., a picture, computer printout, or hand sketch of what the oscilloscope captures on its display). Use this image to determine the following parameters:
 - a) Maximum pulse energy
 - b) Pulse width
 - c) FWHM (full width half max)
 - d) Rise time
 - e) Fall time
 - f) Pulse repetition rate
7. Record these parameters in Data Table 1 as measured values.
8. Using results from Laboratory 2-2 in this course, calculate the pulse repetition time. Record this value in Data Table 1 as a measured value.
9. Look in the laser's user manual to find the parameters listed in step 6. Record these values in Data Table 1 as specified values.

Data Table 1

Parameters	Specified Value	Measured Value
Energy peak		
Pulse width		
FWHM		
Rise time		
Fall time		
Pulse repetition rate		
Pulse repetition time		

10. Compare the specified and measured values. If they differ significantly, explain in your laboratory report what may have caused this difference or, with the permission of your instructor, retake the measurements.
11. Once you have collected and recorded your data, return the laser to standby mode, replace the beam block, power down the laser, secure the lab, and ask your lab instructor for further instructions.

WORKPLACE SCENARIO

Here is your opportunity to use the concepts you have learned in this module to solve an actual problem that could arise in a photonics company. Your instructor will provide directions for developing a solution.

Diagnosing the Doctor's Excimer Laser

Scenario

A cardiovascular surgeon needs a 308 nm excimer laser to conduct cardiovascular laser angioplasty. The parameters of the excimer laser are not up to specification. The beam appears to be lopsided, and the pulsed duration is below 100 ns. Upon further investigation, the maximum energy is well below normal—almost 50% of maximum—so the laser would be ineffective for use in scheduled procedures.

The surgical nurse would like to know what is causing the problem. They have canceled and rescheduled the rest of the day's procedures, and they would like to know when the laser will be available for use. Your report and recommendation will determine this availability

Additional Information

Use the following sources to find the information you need to solve this problem:

1. The explanation of the laser's output characteristics in Module 2-9, *Excimer Lasers and Their Applications*
2. An Internet search of "excimer laser tutorials"
3. Your class notes and discussions and any resources available from your instructor

Problem and Tasking

1. Research the optimum performance criteria for the safe and effective use of the laser in cardiovascular procedures. Are there any risks to the patient if the laser is used but not effective?
2. Research common causes for poor beam characteristics in excimer lasers.
 - a) What are possible causes for poor beam characteristics?
 - b) Does this type of laser have any intrinsic characteristics that make it prone to fail?
 - c) What corrective actions can the technician can make to solve these failures?
3. Determine how the number of failures can be reduced in the future.
 - a) How can these problems be prevented in the future to eliminate schedule cancellations?
 - b) What predictive measures can be taken to prepare for future failures?
 - c) What precautions should be taken to limit risk to the patient?

PROBLEMS EXERCISES AND QUESTIONS

1. Define the terms *excimer* and *dimer*.
2. Name the two most important excimer lasers and state their wavelengths.
3. Describe the process by which excimer lasers operate, including the method by which metastable excimer molecules are formed.
4. Describe the breakup of metastable excimer molecules.
5. Describe two methods of producing high-energy electrons for producing the excited state of an excimer molecule.
6. Describe problems associated with excimer lasers.
7. Describe issues of site preparation for excimer lasers.
8. Briefly describe at least two applications of excimer lasers.

REFERENCES

- Coherent, Inc. 2007. *Excimer Lasers: Releasing the Power of UV*, in *The Photonics Handbook 2007*. Pittsfield, MA: Laurin Publishing.
- Higgins, Jim. 2010. Excimer Lasers Machine in the UV. *Laser Focus World* Nashua, NH: PennWell Corporation. June.

INDEX OF TERMS

A

Active laser medium, 8
Applications, 8-9

B

Buffer gas (see carrier gas), 8

C

Carrier gas, 5
Cold microprocessing, 8
Cooling, 8
Corrosive gas mixtures, 7

D

Dimer laser (see excimer laser), 1, 2, 6

E

Efficiency, 8
Excimer laser, 1
Exciplex laser (see excimer laser), 1
Excited state (see population inversion), 3-4
Exhaust ventilation, 8

F

Flush gas, 8

G

Gas mixture deterioration, 7

N

Noble gases, 1, 8

O

Output characteristics, 6

P

Population inversion (see excited state), 3-4
Power supply, 8
Pulsed lasers, 4, 6-7

R

Rare gases (see noble gases), 1

S

Safety considerations, 11-12

T

Troubleshooting, 13

W

Wavelengths produced, 5

Systems Integration in Photonics

Module 2-10

of

Course 2, *Laser Systems and Applications*
2nd Edition

OPTICS AND PHOTONICS SERIES



© 2016 University of Central Florida

This material was developed by the National Center for Optics and Photonics Education, OP-TEC, and is based upon work supported by the National Science Foundation under Grant No. 1144377 and completed under Grant No. 1303732. Any opinions, findings, and conclusions or recommendations expressed in this material are those of the author(s) and do not necessarily reflect the views of the National Science Foundation.

For more information about the text or OP-TEC, contact:

Dan Hull

PI, Executive Director, OP-TEC

316 Kelly Drive

Waco, TX 76710

(254) 751-9000

hull@op-tec.org

Published and distributed by

OP-TEC

316 Kelly Drive

Waco, TX 76710

254-751-9000

<http://www.op-tec.org/>

ISBN 978-0-9983480-9-4

CONTENTS OF MODULE 2-10

Introduction	1
Photonics in IT and Communication Systems	2
Lasers in Materials Processing Systems.....	2
Lasers in Digital Optical Disc Storage Systems (CD and DVD Recorders and Players)	3
Photonics in Laser Surgery Systems	5
Photonics in Laser-Jet Printer Systems	5
3-D Printers	6
Lasers in Radars, Guidance Systems, and Ranging Systems	7
Prerequisites	8
Objectives.....	8
Basic Concepts	8
System Integration: Making Subsystems Fit Together and Work Together	8
The Basics of System Integration.....	9
The Role of Photonics System Technicians in Systems Integration	10
Systems Integration Steps	11
Integration and Installation Plans	12
Start-Up Procedures	13
Verification Testing.....	14
Documentation Procedures	15
Summary	15
Laboratory	16
Problems Exercises and Questions.....	17
References	18
Index of Terms	19

Module 2-10

Systems Integration in Photonics



INTRODUCTION

Photonics is an “enabling technology.” This means that lasers, LEDs, electro-optical systems, and optics are used in a wide variety of equipment, devices, and processes, either as the critical (enabling) element, or to improve the performance of the equipment or process. Several examples illustrate the enabling power of photonics.

Photonics in IT and Communication Systems

High-speed Internet systems use laser diodes for transmitters, optical detectors for receivers, and fiber-optic cable for the transmission medium. These photonics devices increase the bandwidth (data-rate capacity) to over one million times the bandwidth of systems that use copper wire. For more details on how lasers are used in data storage, go to The National Center for Optics and Photonics Education (OP-TEC) website (www.op-tec.org) and download a copy of the Photonics-Enabled Technologies (PET) series publication entitled *Principles of Fiber-Optic Communication*.

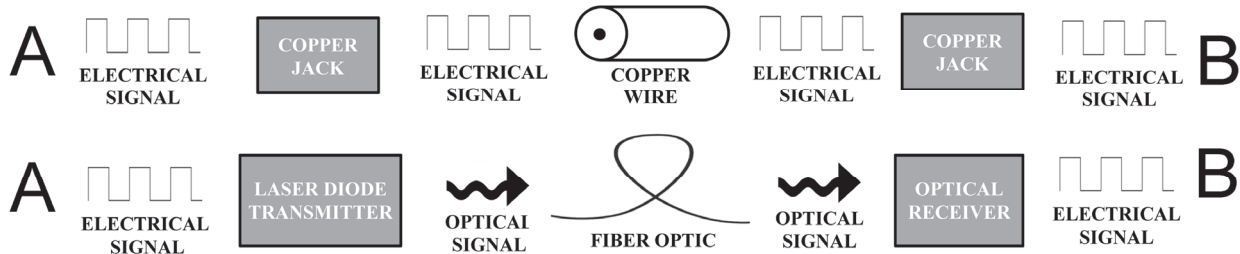
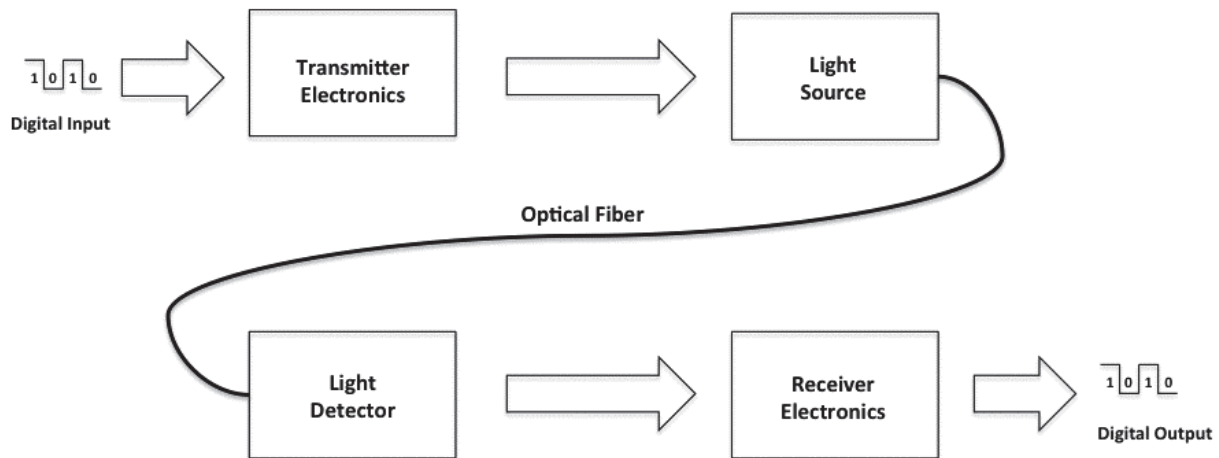

Figure 10-1 Schematics of fiber-optic communication systems

Lasers in Materials Processing Systems

Lasers are used as the directed heat source for welding, drilling, cutting, etching, and other processes that require melting or partial vaporization of a material. Lasers are used for these operations because they allow for control, accuracy, and precision. Laser materials processing can also reduce distortion of the material and produce cleaner cuts, holes, welds, etc. For more details on how lasers are used in materials processing, go to The National Center for Optics and Photonics Education (OP-TEC) website (www.op-tec.org) and download copies of the Photonics Enabled Technologies (PET) series publications entitled *Laser Welding and Surface Treatment* and *Laser Material Removal: Drilling, Cutting, and Marking*. Other PET series modules that are related to materials working include *Lasers in Testing and Measurement: Alignment, Profiling, and Position Sensing* and *Lasers in Testing and Measurement: Interferometric Methods and Nondestructive Testing*.

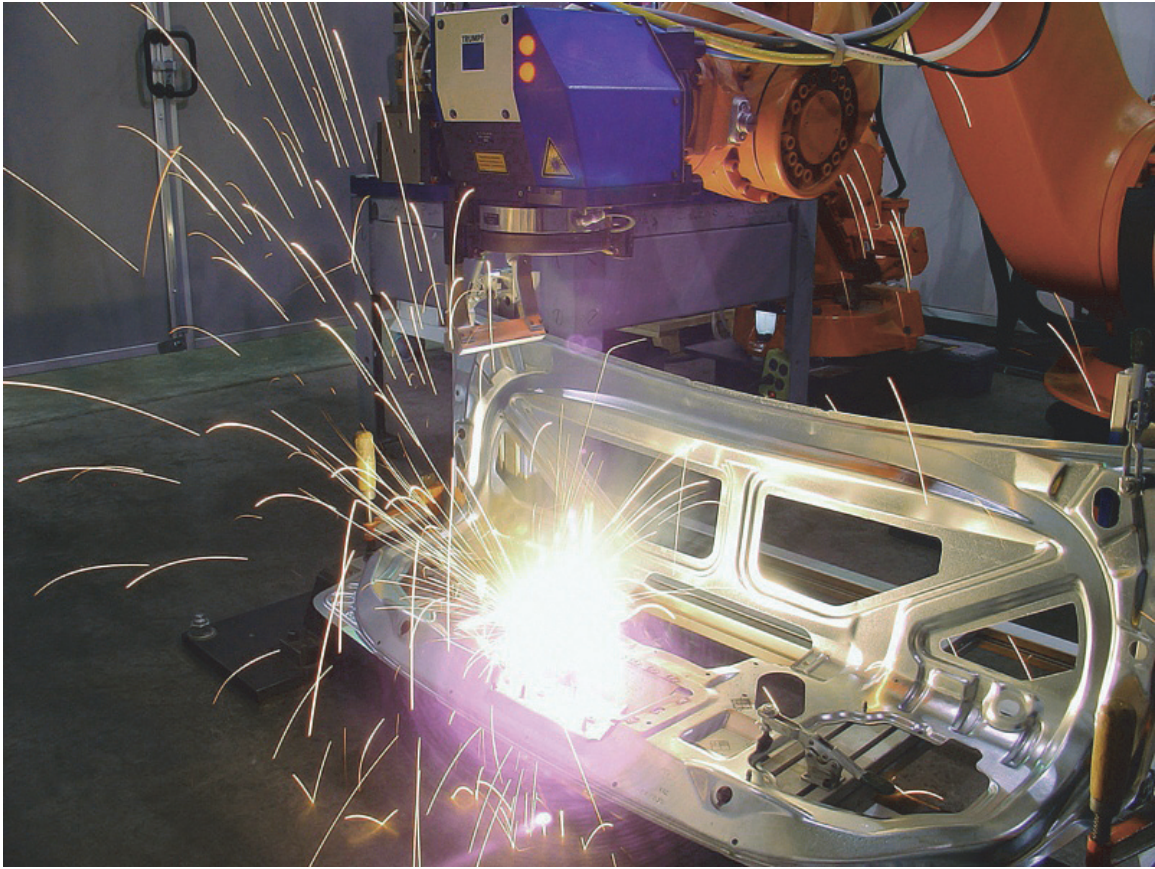

Figure 10-2 *Photonics-enabled manufacturing. (Rights: Fraunhofer CCL, USA.)*

Lasers in Digital Optical Disc Storage Systems (CD and DVD Recorders and Players)

Laser beams are used to create surface irregularities to record sound and video data on compact discs and digital video discs. Lasers are also used to “read” these discs: a laser scans the irregularities on the disc, and an optical detector detects the laser beam’s reflections. The irregularities on the disc modulate the reflected beam, producing digital signals that can be converted to audio and video information. For more details on how lasers are used to store data, go to The National Center for Optics and Photonics Education (OP-TEC) website (www.op-tec.org) and download copies of the Photonics Enabled Technologies (PET) series publication entitled *Photonics Devices for Imaging, Storage, and Display*.

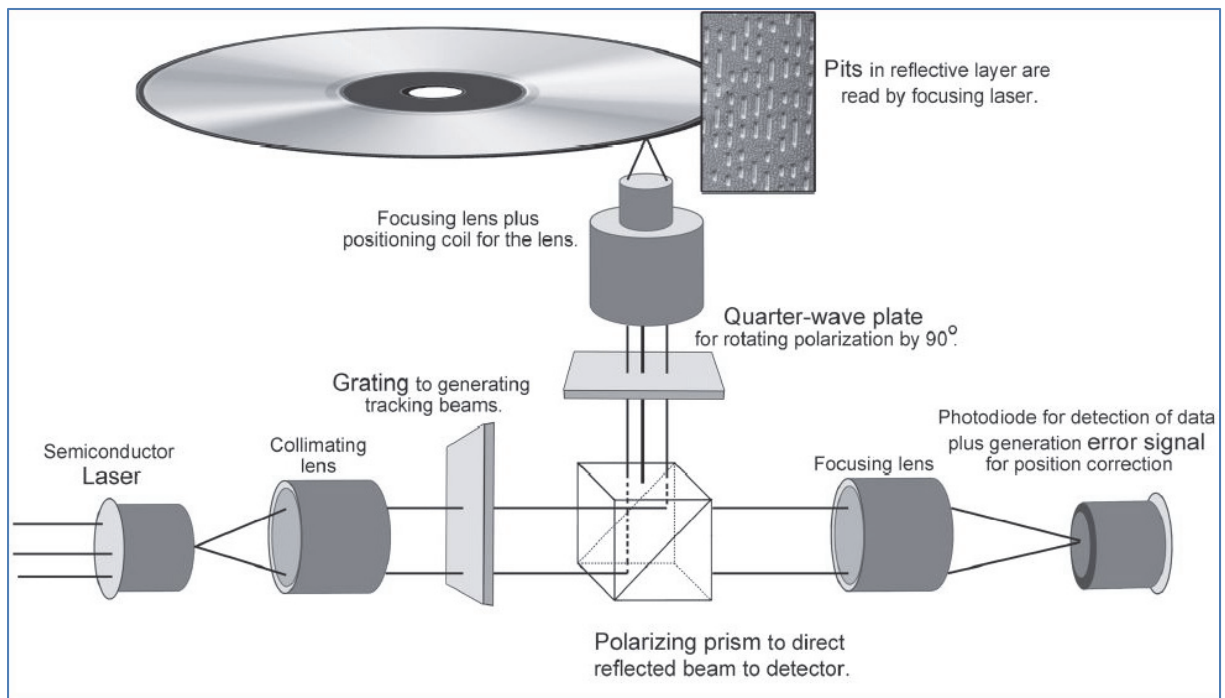
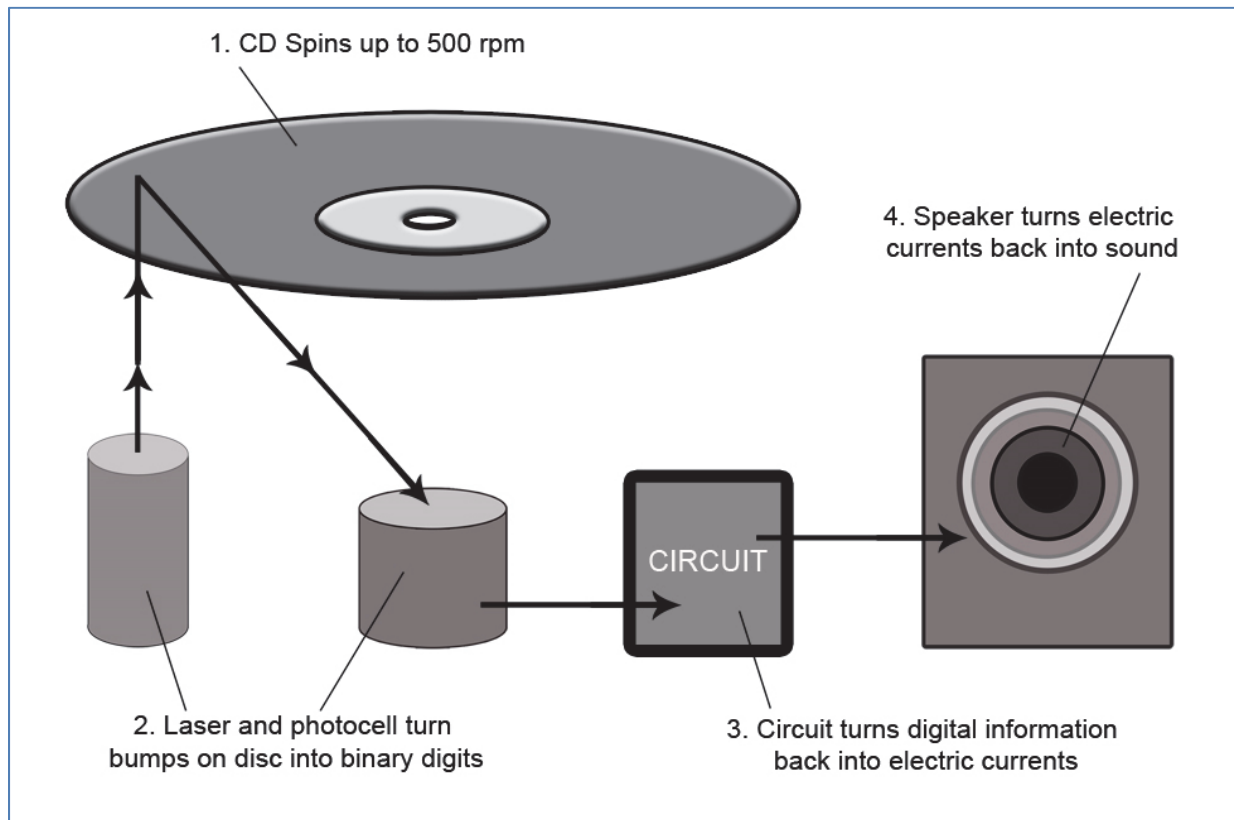

Figure 10-3 Digital optical storage systems

Photonics in Laser Surgery Systems

Lasers are used as the “scalpel” to cut or remove (by vaporization or ablation) tissues in the eyes, skin, tumors, and certain organs. Sometimes the laser beam is applied directly to the tissue; sometimes it is directed through a fiber-optic cable to avoid invasive surgery. The particular wavelength of a laser beam allows it to be selectively absorbed (through dyes, etc.) in one tissue region or organ and leave surrounding tissues unaffected. Lasers are also used to photocoagulate bleeding tissue or veins, such as those in the retina of the eye. For more details on how lasers are used in medicine, go to The National Center for Optics and Photonics Education (OP-TEC) website (www.op-tec.org) and download copies of the Photonics Enabled Technologies (PET) series publications entitled *Lasers in Medicine and Surgery*, *Therapeutic Applications of Lasers*, and *Diagnostic Applications of Lasers*.



Figure 10-4 *Lasers in surgery. (U.S. Navy photo by Mass Communication Specialist 1st Class Brien Aho, RELEASED).*

Photonics in Laser-Jet Printer Systems

Lasers are used in printers and copy machines to transpose digital images (letters, words, pictures, etc.) onto the photoreceptor that applies toner to the paper.

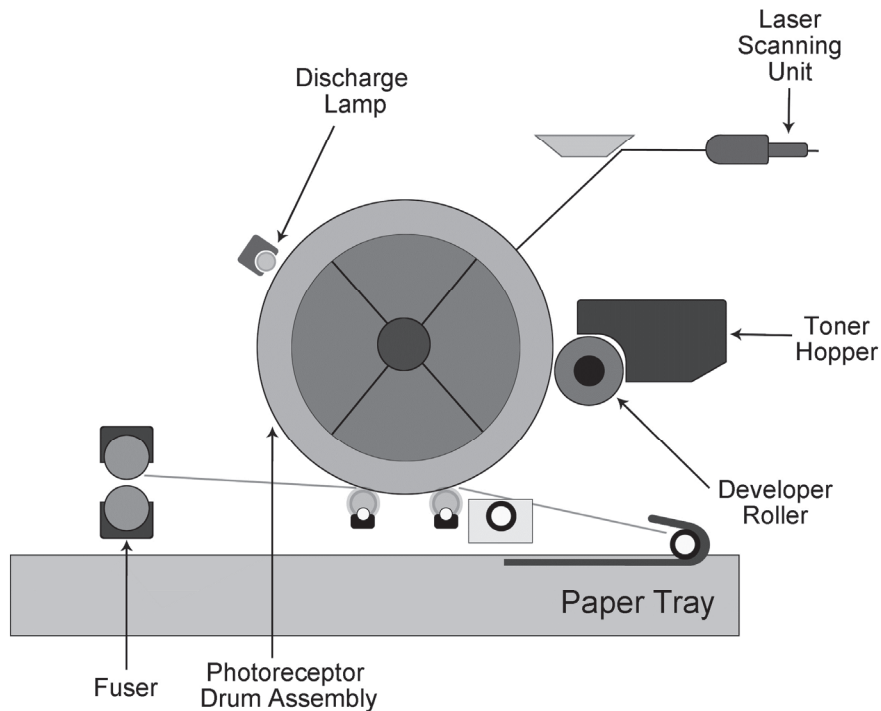

Figure 10-5 *Laser jet printer system*

These printers use dry ink known as “toner,” which is charged with static electricity and then heated to place and bond the ink onto the paper.

3-D Printers

A scanner or a 3-D CAD design program can be used to create a 3-D image of an object that is then sent to a printer. The printer then forms the desired shape by depositing granular material (e.g., plastic or resin) in layers onto a platform. The printer starts with the bottom layer and sometimes using a UV light or laser to harden the material before proceeding to the next layer. Each layer may change shape so that the composite layers form an irregular shape that cannot be created by machining. This action of 3-D printers is sometimes called “additive manufacturing” because the processes “creates objects,” in contrast to “subtractive manufacturing,” in which machines remove material to form objects. Additive manufacturing allows the creation of irregularly shaped objects, such as artificial bones, which cannot be created by machining.

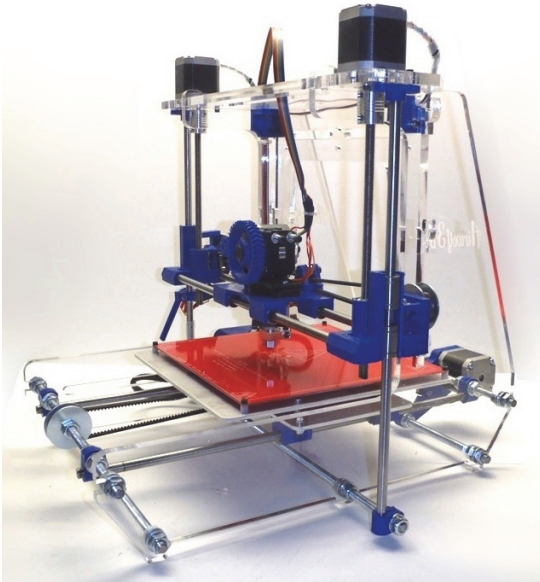

Figure 10-6 3-D printer with typical images

Lasers in Radars, Guidance Systems, and Ranging Systems

Laser beams can be aimed at objects to illuminate them. The reflected laser wavelength can then be detected to determine the position and distance to the object. A modulated (usually pulsed) laser beam allows the detecting device to determine distance by measuring the time it takes to transmit and receive the reflected pulse; this figure allows distances to be accurately calculated. These “laser radars” are used for military fire control; highway patrolmen also use them to catch speeding cars.



Figure 10-7 Applications for laser range finders. (Courtesy of Kustom Signals).

These examples highlight lasers as enabling components in systems. As each example suggests, if a laser is to enable a system, it must interact with subsystems that 1) give it the inputs it needs to function and 2) receive and process the laser's output. *Systems integration* is the process of bringing component subsystems together and ensuring that the subsystems function together as a system. This module covers the basics of systems integration for photonics-enabled devices, discusses techniques technicians use to integrate photonics components into systems, and gives students an opportunity to practice these techniques by developing a photonics-based system.

PREREQUISITES

OP-TEC's *Fundamentals of Light and Lasers Course*

OP-TEC's *Laser Systems and Applications Course, Module 1: Laser Q-Switching, Mode Locking, and Frequency Doubling, Module 2: Laser Output Characteristics and Module 3: Laser Types and Their Applications*

Understanding of high school level trigonometry and algebra concepts, including exponentials and logarithms

OBJECTIVES

Upon completion of this module, the student should be able to:

- Identify the subsystems in 8–10 systems that are enabled by photonics.
- Show how each subsystem in a photonics-enabled system relates to the others.
- Describe interfaces and compatibilities among subsystems in four photonics-enabled systems. How are they developed and measured?
- Describe the functions and sequence of the systems integration tasks that a photonics systems technician performs.
- Create integration and installation tasks and procedures for a photonics-enabled system.
- Describe the start-up for systems integration of a photonics-enabled device.
- Describe examples of verification testing that may be performed on a photonics-enabled integrated system.

BASIC CONCEPTS

System Integration: Making Subsystems Fit Together and Work Together

It's useful to consider equipment as *systems* that are composed of *subsystems*. In each of the kinds of equipment mentioned in this module's introduction, a laser, electro-optic device, or optical assembly (photonics device) is a key element that either delivers digital signals, directs

heat (laser beam), manipulates light-energy characteristics, or provides illumination. For the equipment to operate properly, the photonics device must be mounted, activated, controlled, and measured using other devices—other subsystems. Earlier modules in this course have described some of the subsystems that photonics devices often require: power supplies, mounting fixtures, heating or cooling devices, material transporters, digital controllers, collimating optics, aiming devices, and various electronic circuits.

A major goal of a technician is to ensure that all subsystems fit together and work together to produce results consistent with a device's specifications. The process of ensuring this fit and coordinated functioning is called *systems integration*.

The Basics of System Integration

For subsystems to work together as an integrated system, each element, or subsystem, must be made to complement and support the other elements. When all subsystems complement one another and perform according to design specifications, the subsystems are said to be *compatible*. Typical compatibilities related to photonics subsystems are:

- Electrical compatibility
- Power requirements/voltage levels
- Electronics compatibility
- Input/output interfaces
- Environmental compatibility
- Mechanical/structural compatibility
- Mounting/aligning optical components & systems
- Stability
- End-to-end checkout procedures

Engineering systems integration (ESI) is the process of assembling equipment together in some manner that involves interfaces and transfers of various types. ESI is predominately concerned with the design of the system, subsystems, and interfaces; the process of integrating the subsystems into an integrated system; and testing the integrated system for reliability and other characteristics. ESI is based on systems' and subsystems' performance specifications, which are agreed upon between the user(s) and the supplier. These specifications include interface requirements of the various subsystems. Below is an example of a photonics-enabled integrated system.

Example 1

Laser Welding Systems

Laser welding equipment may include the following subsystems:

- Laser
- Power supplies for:

- Laser
 - Cooling apparatus
 - Materials-moving equipment or laser beam scanner
 - Beam-handling equipment (focusing and aiming optics, as well as their support structures)
 - Mechanical supports to hold the pieces to be welded
 - Electromechanical devices to move the welded pieces across the path of the laser beam
 - Opto-mechanical or electro-optical devices that scan the laser beam across the pieces to be welded
 - Laser cooling, if necessary
 - Gas to assist the welding process
 - Control devices to regulate:
 - Laser output power
 - Laser cooling
 - Position and movement speed of the parts to be welded
 - Laser beam scanning position and speed
 - Robotics equipment to automatically insert and remove materials to be welded
-

The Role of Photonics System Technicians in Systems Integration

Photonics systems technicians (PSTs) support engineering systems integrators because they are uniquely prepared to ensure that each system performs according to its ESI design specifications and that subsystem interfaces are compatible. Photonics systems technicians need to accurately measure the subsystem's performance characteristics, and if these characteristics are substandard, make appropriate adjustments to bring the subsystem to design specifications. The role of the PST is to install, test, maintain, and repair a photonics-enabled system so that it performs according to required specifications. To do this, PSTs must also examine the interfaces between the photonics device, subsystems that support it, and subsystems that the photonics device supports.

Systems integration teams may also include technicians who specialize in electronics, mechanics, fluids, computer controls, software, and manufacturing processes. It is not likely that any of these technicians will have experience with or working knowledge of lasers or optics. But photonics systems technicians not only specialize in lasers and optics, but also have a broad understanding of electrical, electronics, mechanical, computer, and control systems. Therefore, PSTs have the necessary background to lead the technical team. Overall design, operations, and planning will be the responsibility of the systems integration engineer.

To better understand the role of the PST in systems integration, let's take a particular photonics-enabled system, a laser welder, and list some tasks that a PST performs to ensure that this system is operating within specifications. The PST:

- Assures that the electrical power supplies for the laser, cooling apparatus, and materials-handling equipment provide adequate power at the required AC and/or DC voltages.
- Measures each subsystem against specifications to assure systems integration compatibility.
- Determines whether laser-cooling equipment is adequate to hold the laser to the desired temperature range.
- Measures the laser output to determine whether the beam meets systems specifications for power, temporal characteristics, spatial characteristics, and stability.
- Tests the beam-handling equipment for performance accuracy, mechanical stability, and beam quality.
- Tests the equipment that scans the laser beam or materials-moving equipment to determine whether the laser beam is delivered to the welded pieces and moves across the line to be welded at the specified accuracy and rate.
- Ensures that the laser provides a weld that meets specifications for each application and different type of material to be welded.
- Ensures that the system meets reliability stress-testing requirements, including high-temperature testing and vibration testing.
- Ensures that all operational safety requirements are met.

Assignment A

- Choose one subsystem of an integrated laser welding system. (Refer to laser welding systems listed in the Photonics Enabled Technologies series, or find and research one on the Internet.)
- List some inputs and outputs to the subsystem you have selected, and label these as internal or external input(s) and output(s).
- List the subsystem(s) in the integrated laser welding system that would be connected to the subsystem you have selected.
- List at least one specification associated with each input and output, and identify the subsystem it will be connected to with reference to the input or output specification.
- List one test you may incorporate as a PST to ensure that the integrated system meets overall specifications related to the subsystem you selected.

Systems Integration Steps

An effective system integration process starts with planning and ends with documentation. Ultimately, the goal is for all subsystems in a device to support one another and allow the device to function as designed. The following steps provide a broad outline of how a PST can plan and implement a systems integration process.

Integration and Installation Plans

Continuing with the example of a laser welder, we will first examine the tasks necessary to integrate the subsystems of the laser welder; we will then determine appropriate procedures for installing the laser welder into an operational setting.

1. To integrate the laser welding equipment's subsystems, you need to know the required laser specifications, optics specifications, and performance specifications. Under guidelines established by the EST, PSTs obtain and document these specifications, which may include answers to the following questions:
 - a) What is the manufacturer and model of the selected laser?
 - b) What is the range of performance specifications for this laser?
 - c) If the laser is not in CW operation, what are the pulse width and PRF of the output beam?
 - d) Is the measured stability of the laser output adequate? (Stability describes fluctuations in the laser beam's power and fluctuations in the beam's position.)
 - e) Over what power range can the laser operate efficiently?
 - f) What other operations can this laser perform?
 - g) Some welding operations require a particular gas environment to enhance (assist) the process. Is gas assist specified? What gas? Why?
2. To install the laser welder subsystem into the welding system, you will need to know certain material requirements and production parameters such as the material's dimensions, desired welding speed, and desired production rate (how many parts welded per hour).
 - a) What are the size and weight of the laser?
 - b) What are the input power and cooling requirements of the laser?
 - c) What is the material to be welded, and what are the dimensions of the piece to be welded? What is the desired welding speed?
 - d) Will the parts to be welded be moved across the laser beam, or will the laser beam be scanned across the parts?
 - I. If the parts are to be moved across the beam, what fixture and equipment will you need?
 - II. If the beam is to be scanned across the welded parts, what optics and optical-mechanical scan equipment will you need?
 - III. What control devices are needed to effectively perform the welding operation?
3. What safety equipment and procedures will be required?
4. What spare parts should you keep available?
5. What storage facilities and supplemental prep stations are needed?
 - a) Performance testing the integrated welding system:
 - I. What are the specifications to be met?

- II. What testing will be required to ensure that the integrated laser welding system meets specifications?
 - III. What stress tests need to be incorporated to ensure that the system meets reliability requirements?
- b) Create a sequence of tasks and prioritizations for accomplishing the systems integration.

Assignment B

- Identify a laser that may be used in a laser keratotomy eye surgery system. (Refer to the Internet to choose a laser.)
- As a PST, if you were responsible for integrating the laser into the system, list five actions you would perform (e.g., incoming inspection, compatibility, user specifications, safety, etc.)
- List tests and procedures you would implement to accomplish these actions.

Start-Up Procedures

Once you and your team have established the systems performance specifications, selected and refined the components and subsystems, ensured that subsystems are performing to specifications, and prepared the prototype test facility, you should plan and schedule the systems integration procedures. The systems integration start-up is usually a team effort, led by the systems integration engineer.

- Usually, specialists have developed and tested each subsystem in isolation. The integration team should include representatives from each subsystem team. These representatives should meet periodically to discuss progress, identify issues that may have developed (such as unexpected performance limitations of a subsystem), and define criteria for interface compatibilities between subsystems.
- *Interface compatibility* ensures that each subsystem will adequately support the other subsystems. This task begins with collecting information on the “input-output” requirements of each subsystem as it relates to any and all other subsystems. In a laser welding system, for example, the laser subsystem requires inputs from other systems to provide appropriate electrical power, cooling, stable mounts, output power controls, and beam-delivery optics. In turn, the output from the laser must be responsive to the controller and must deliver the required beam power and quality to the beam-delivery optics. You and your team should demonstrate and document interface compatibility between subsystems before initiating systems integration start-up procedures.
- The systems integration team should establish a protocol for start-up testing of subsystems. This protocol should specify which two subsystems initiate the start-up and the order in which subsequent subsystems should be added. You and your team should measure and document the performance of the composite subsystems before you add another subsystem. When the system is totally operational and meets all performance specifications, you have completed the start-up procedure. If there are deficiencies, they

should be documented and analyzed. The systems integration team should take corrective action for each deficiency identified and repeat the start-up procedure.

Assignment C

Given an integrated laser single-mode fiber-optic communication system consisting of a transmitter, fiber, and receiver, perform the following tasks:

1. List one compatibility specification between each connected subsystem.
2. List a measurement you would incorporate as a PST to ensure that each of these specifications will be met when the system is integrated.
3. Create a procedure for integration of this system.
4. What is the “end-to-end” test required to validate the start-up?

You may find it useful to use the OP-TEC Photonics –Enabled Technologies module entitled, *Principles of Fiber-Optic Communication*, for reference. Go to www.op-tec.org to download a copy.

Verification Testing

After your team has successfully completed the start-up procedure, you should initiate system-verification testing and record and document test results. Your team should establish criteria and measurements to use to determine whether the system is operating properly. Five results are expected from verification testing:

- Conduct at least ten start-ups and runs to verify that the system is operating reliably and according to performance specifications.
 - Establish time durations of the runs to verify consistency in system performance and resistance of system performance to degradation due to overheating or mechanical instability. Document variations in system performance to ensure long term accuracy and reliability.
 - Test a variety of operating speeds and performance requirements to determine the flexibility of the system’s performance. For instance, in a laser welding system, vary the material and dimensions of the welded part, as well as the speed of the welding operation.
 - Determine the reliability of the system. Reliability testing may include high-temperature testing, low-temperature testing, vibration testing, and life testing.
 - Verify that safety regulations are met.
-

Assignment D

Create a verification test procedure with at least five steps for a ground-based battlefield laser tracking and ranging system.

Documentation Procedures

Documentation of all aspects of systems integration should be defined, maintained, reviewed, and stored appropriately. This formal documentation is typically kept in individual lab notebooks maintained by the technicians. All documentation, including lab notebooks, should be kept up to date and should be dated and signed by the technician who prepares them. This includes:

- Documentation of system-design and performance specifications
- Operating and maintenance manuals for all equipment in each subsystem
- Documentation of procedures and results in subsystem performance and interface tests
- Documentation of procedures and results in system start-ups
- Documentation of procedures and results in verification testing

Assignment E

Write a paper explaining why systems integration documentation is important to suppliers of the integration company, different departments of the integration organization, and customers of that integration company.

Summary

This module has presented a basic description of the process of systems integration as it relates to photonics-enabled devices. The key to effective systems integration lies in making all subsystems of a device fit together and work together. Photonics systems technicians perform systems integration operations that ensure that photonics subsystems embedded in a device have the necessary inputs (power, cooling, control, etc.) and outputs (pulse width, pulse repetition rate, frequency, power, etc.) to allow the device to operate within design specifications. To ensure the compatibility of the photonic subsystems with the device's other subsystems, the PST follows a series of steps that include developing plans for integrating and implementing the subsystem, performing start-up procedures, conducting verification testing, and documenting the systems integration process.

LABORATORY

Laboratory 2-10 Developing a Fiber-Optic Communication System

Purpose

The purpose of this lab is to design a simple fiber-optic communication system and use the systems integration techniques explained in this module to assemble the system and verify its operation.

Equipment

A photonics systems technician has expertise in electronics. This expertise includes designing electronic circuits and building these circuits to meet design specifications. In this lab you will design a simple fiber-optic communication system that includes the following components:

1. One LED or transistor transmitter
2. Plastic-fiber medium
3. Opto-detector receiver

Check with your instructor to determine the electronic components available for this laboratory. Your design should only use parts that are readily available at your institution. If your design requires components that are not available at your institution, see your instructor for guidance in altering your design or obtaining the needed components.

Documentation

This module stresses the importance of documentation in systems integration processes. In this laboratory, keep a notebook that documents each step in the “Procedures” section.

Procedures

1. Design your fiber-optic circuit, and acquire the components needed to assemble it.
2. Identify and list details of the subsystems in your design.
3. Identify one compatibility specification for each subsystem.
4. Develop integration plans, procedures, and tests for your circuit.
5. Assemble your circuit.
6. Perform measurements to ensure subsystem compatibilities.
7. Perform start-up procedures.
8. Validate proper system operation.

PROBLEMS EXERCISES AND QUESTIONS

1. List the typical compatibilities related to photonics subsystems.
2. Define engineering systems integration (ESI).
3. List the tasks a photonics systems technician (PST) performs in ensuring a laser welder is operating within specifications.
4. What are the initial and final steps in an effective system integration process? What is the ultimate goal of system integration?
5. What should a subsystem start-up testing protocol include?
6. List the five results expected from verification testing.
7. During a system integration process, what documentation should be generated, kept updated, and stored?

REFERENCES

This module is a capstone for the *Laser Systems and Applications* course. Thus, the best references for this module are the other modules in this course. As you read this module, you will come across a number of technical terms related to laser operations, laser output, and devices that measure this output. If you need more information on these terms, refer to Modules 2-1 and 2-2. This module also mentions specific laser systems and challenges you to use systems integration techniques to support them. Detailed information on these laser systems is provided in Modules 2-4 through 2-9 of the course. If, in reading this module, you require a comparison of various laser systems and their applications, this type of information is available in Module 2-3. Should you need more detailed information about a laser application than what Module 2-3 provides, you will find it in OP-TEC's Photonics Enabled Technologies (PET) series, which includes applications in the following technology areas:

- Materials processing: welding, surface treatment, drilling, cutting, marking, alignment, profiling, and position sensing
- Fiber-optic communications
- Medical applications
- Spectroscopy
- Environmental monitoring
- Forensic science and homeland security
- Opto-electronics

You can find and download these PET modules from the OP-TEC website, www.op-tec.org.

One final source of references for this module is the Internet. Several websites are rich in laser materials and offer easy access to information.

INDEX OF TERMS

C

Communication systems, 2

Compatible, 9

D

Digital optical disc storage systems, 3

Documentation procedures, 15

E

Engineering systems integration (ESI), 9

I

Integration and installation plans, 12

Interface compatibility, 13

L

Laser surgery systems, 5

Laser-jet printer systems, 5

M

Materials processing systems, 2

P

Photonics systems technician (PST), 10

R

Radars, guidance systems, and ranging systems, 7

S

Start-up procedures, 13

Subsystems, 8

Systems integration, 9

Systems, 8

V

Verification testing, 14

Acronym Glossary

ADP – ammonium dihydrogen phosphate	NA – numerical aperture
COIL – chemical oxygen-iodine laser	NLO – nonlinear optics
CW – continuous wave	OC – output coupler
DBR – distributed Bragg reflector	OD – optical density
DFB – distributed feedback	OFCS – optical fiber communications system
DL – diode laser	OPA – optical parametric amplifier
DPFL – diode pumped fiber laser	OPMS – optical power measuring system
DPSS – diode pumped solid state	OPO – optical parametric oscillator
DUV – deep ultraviolet	OPSL – optically pumped semiconductor laser
ESD – electrostatic discharge	PET – photonics enabled technology
ESD – electrostatic discharge	PRF – pulse repetition frequency
ESI – engineering systems integration	PRR – pulse repetition rate
EUV – extreme ultraviolet	PRT – pulse repetition time
HeNe – helium neon	PST – photonics systems technician
HR – high-reflectivity	QCL – quantum cascade laser
IR – infrared	SESAMs – semiconductor saturable absorber mirrors
KDP – potassium dihydrogen phosphate	SHG – second harmonic generation
LD – laser diode	SOP – standard operating procedure
LED – light emitting diode	TEC – thermoelectric cooler
LIDAR – light detection and ranging	TEM ₀₀ – fundamental mode
LMA – large mode area	UV – ultraviolet
LN – lithium niobate	VCSEL – vertical cavity surface emitting laser
LSO – laser safety officer	WDM – wavelength division multiplexing
MCA – monolithic crystal assembly	YAG – yttrium aluminum garnet
MOPA – master oscillator power amplifier	
MOPFA – master oscillator power fiber amplifier	
MPE – maximum permissible exposures	