



Vehicle:	Year/Prod. Date:	Engine:	Transmission:
----------	------------------	---------	---------------

**Objectives**

This worksheet will familiarize you with:

- Auxiliary battery locations and precautions
- High-voltage warning labels and wiring locations
- Engine maintenance service points
- Inverter maintenance service points
- ATF service points
- Multi-display screens
- Inspection Mode

**Tools and Equipment**

Make sure you have the following tools and equipment before you begin:

- Toyota hybrid vehicle
- 256 Technician Handbook

**Auxiliary Battery**

1. Where is the auxiliary battery located on this vehicle?

---

2. Locate the jump-start terminals for the 12-volt auxiliary battery on this vehicle. Where are they? Can conventional jump-start procedures be used on this vehicle?

---

3. What is the maximum charging amperage for the auxiliary battery on this vehicle?

---

4. Which Toyota hybrid vehicles have a temperature sensor mounted on the battery bracket? (Be careful not to damage the temperature sensor when replacing the battery on these vehicles.)

---

5. What precaution should be taken if a Toyota hybrid vehicle is stored for more than two months?

---

**Underhood Walkaround**

6. What distinguishes high-voltage cables from conventional vehicle cables?

---

---

7. Which components have high-voltage wiring?

---

---

8. Summarize the warning label information on the inverter.

---

---

---

---

9. What type of ATF lubricates the hybrid transaxle?

---

10. Does this vehicle have a coolant heat storage tank? If so, where is it located?

---

Use the following graphics to help you locate the service items on this vehicle. Check them off on the graphic as you find them.

**2001–2003 Prius**

11. Locate the engine oil cap and gauge.

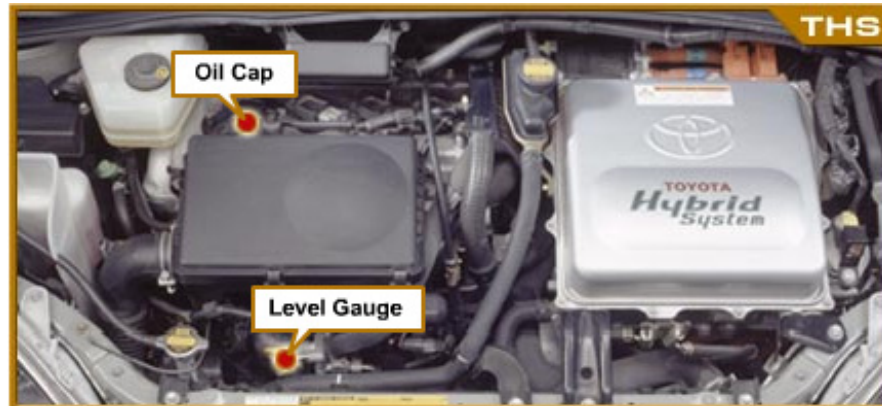

12. Locate the engine drain plug and radiator drain plug.

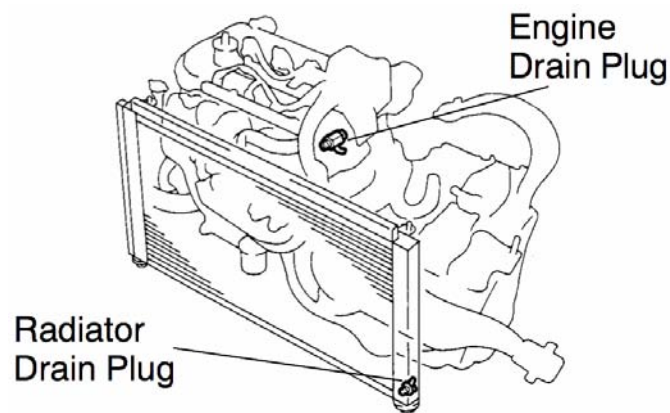

13. Locate the inverter coolant fill and bleed points.

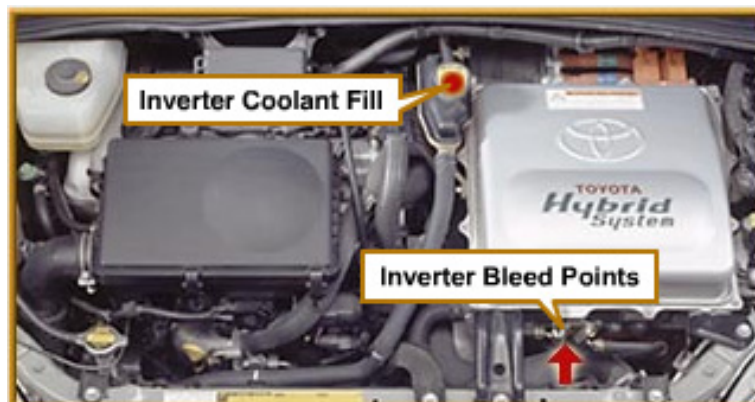

14. Return the vehicle to its original condition.

**2004–2009 Prius**

15. Locate the engine oil cap and gauge.



16. Locate the radiator cap, engine drain cock plug, radiator drain cock plug, and coolant heat storage tank drain cock plug. The instructor may have service tips for bleeding air from the coolant heat storage tank.

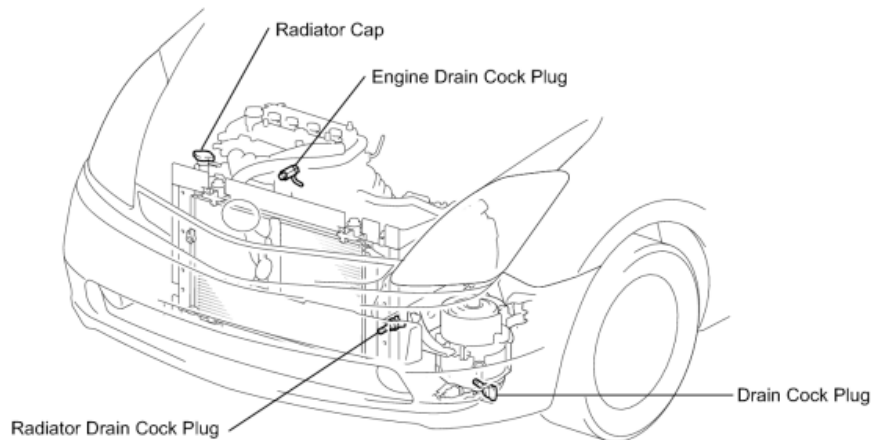

17. Locate the engine oil cap and gauge.

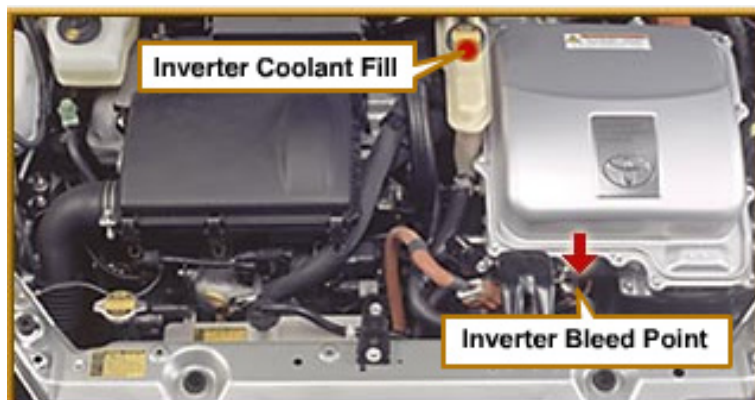

18. Return the vehicle to its original condition.

**2010-and-later Prius**

19. Locate the engine coolant tank, cylinder block drain cock plug, radiator drain cock plug, and air release valve. Also, find the “B” line on the reservoir tank.

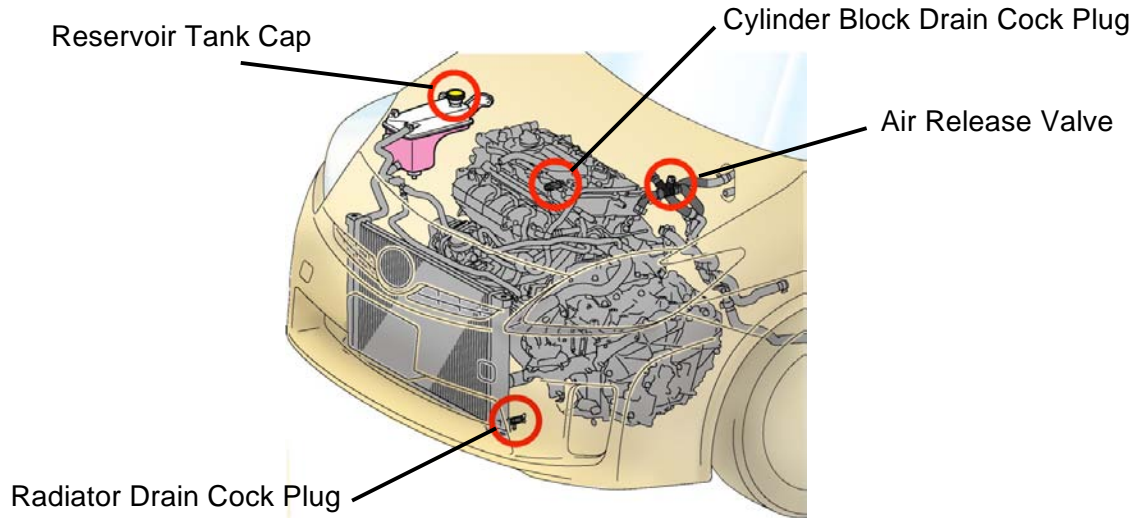

20. Locate the inverter coolant tank.

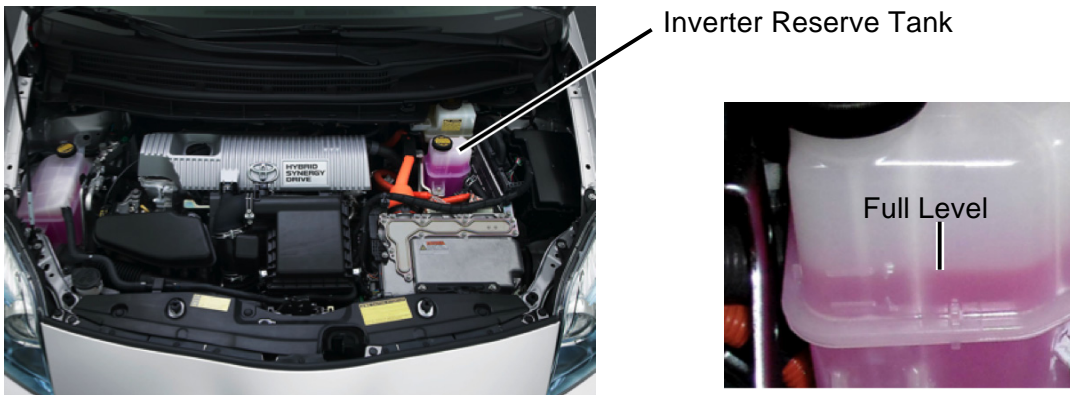

21. Return the vehicle to its original condition.



2006-and-later Highlander Hybrid

22. Locate the engine coolant radiator cap, radiator drain cock plugs, and cylinder block drain cock plug.

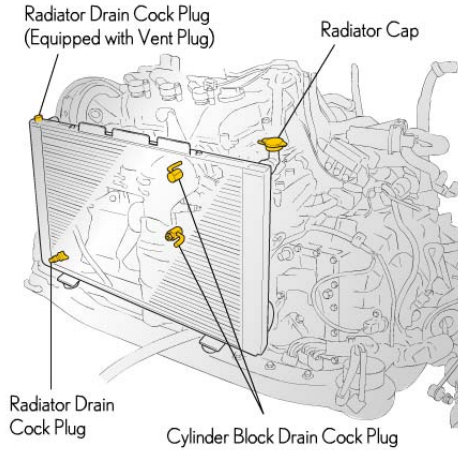

23. Locate the inverter coolant drain plug and air bleed valve on the dedicated inverter radiator. The electric water pump can be operated during service with an Active Test.

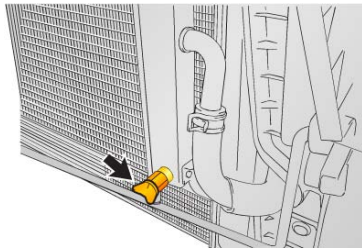

SLLC drain plug located on the dedicated radiator

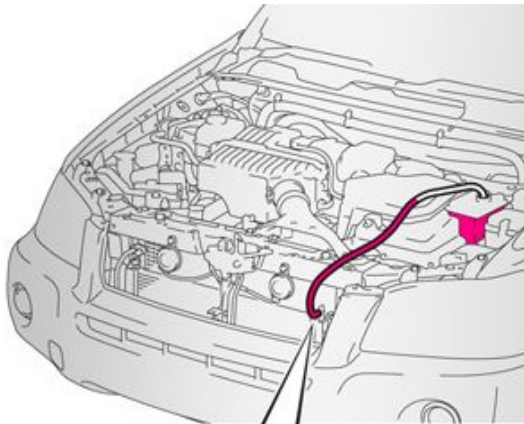

**Note:** A section of clear vinyl tubing, 7/16" OD x 5/16" ID and approximately four feet in length is suitable for the air-bleed procedure. Clear vinyl tubing is available at most hardware stores.



Air bleed valve on top of dedicated radiator

24. Return the vehicle to its original condition.

**Underbody Walkaround**

- 25. Locate the route of the high-voltage cable wiring. Where is the HV wiring hidden from view?

---



---

Put the vehicle on a lift and use the following graphics to help you locate the service items on this vehicle. Check them off on the graphic as you find them.

**2001–2003 Prius**

- 26. Locate the inverter coolant drain and the ATF filler plug and drain.

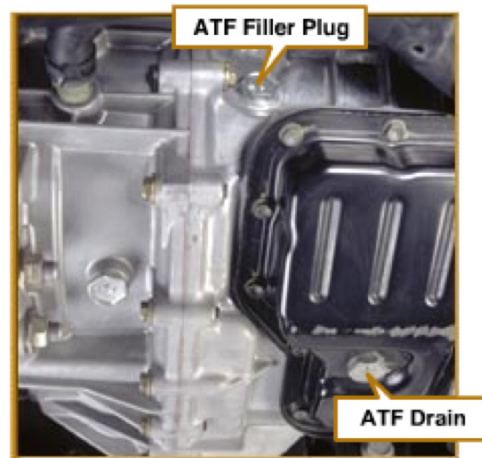
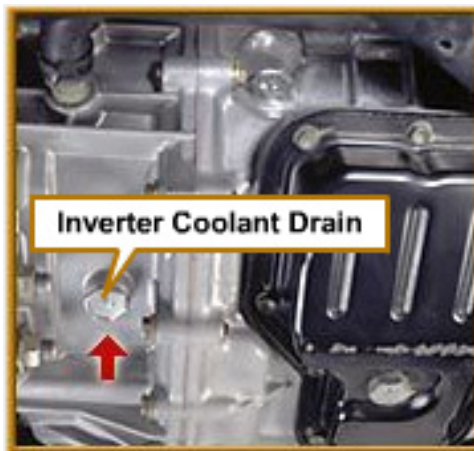

- 27. Return the vehicle to its original condition.

**2004–2009 Prius**

28. Locate the inverter coolant drain and the ATF filler plug and drain.

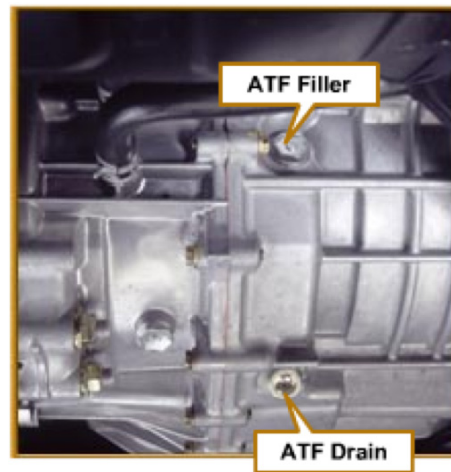

29. Return the vehicle to its original condition.

**2010-and-later Prius**

30. Locate the drain plug for the inverter coolant, and the filler and drain plugs for the hybrid transaxle.

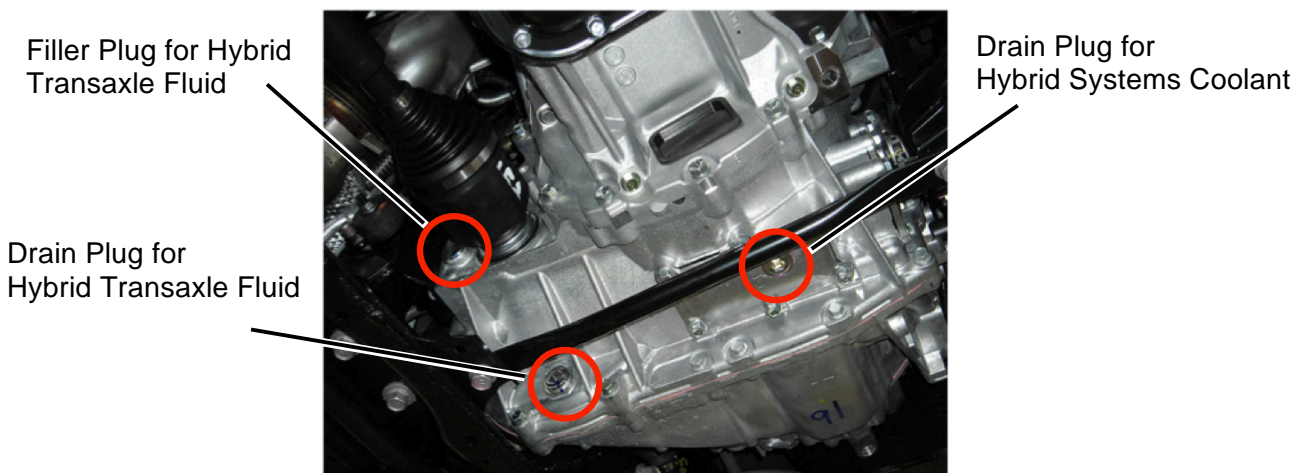

31. How is the engine oil filter accessed?

32. Return the vehicle to its original condition.



**2006-and-later Highlander Hybrid**

33. Locate the transaxle fluid filler and drain plugs and the inverter coolant drain plug.

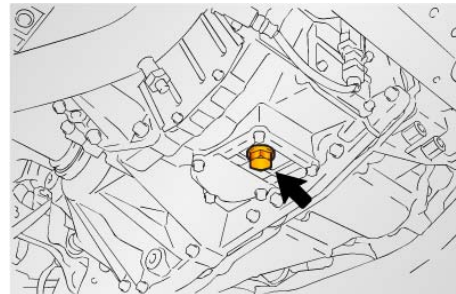
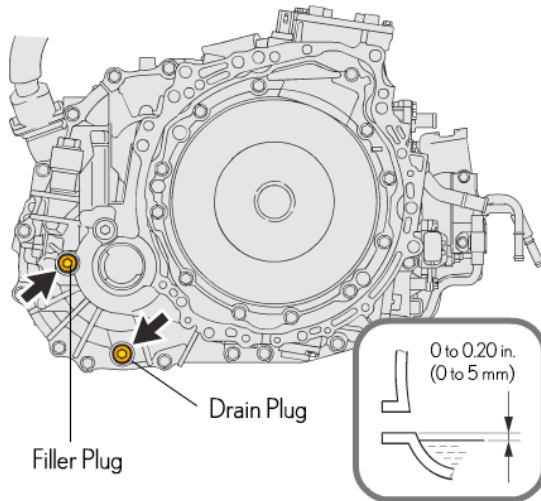

Inverter Coolant  
Drain Plug Location

34. Locate the MGR fluid filler and drain plugs. What type of fluid should be used for MGR?

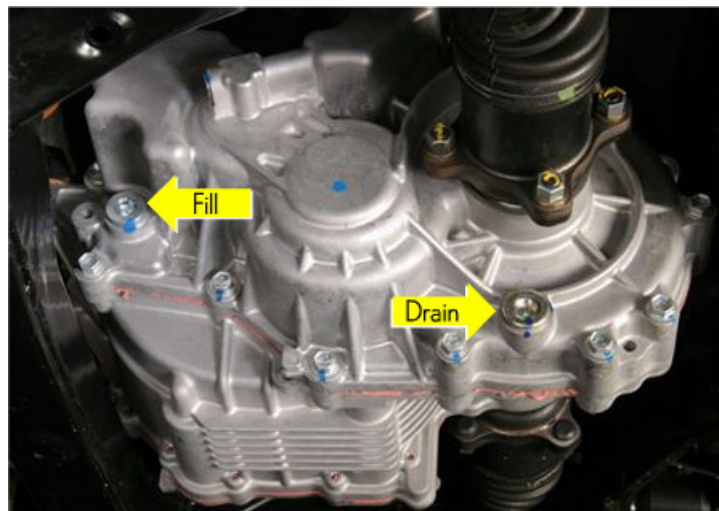

35. Return the vehicle to its original condition.

**2007-and-later Camry Hybrid**

36. Locate the engine coolant radiator cap and drain cock plug, and the cylinder block drain cock plug.

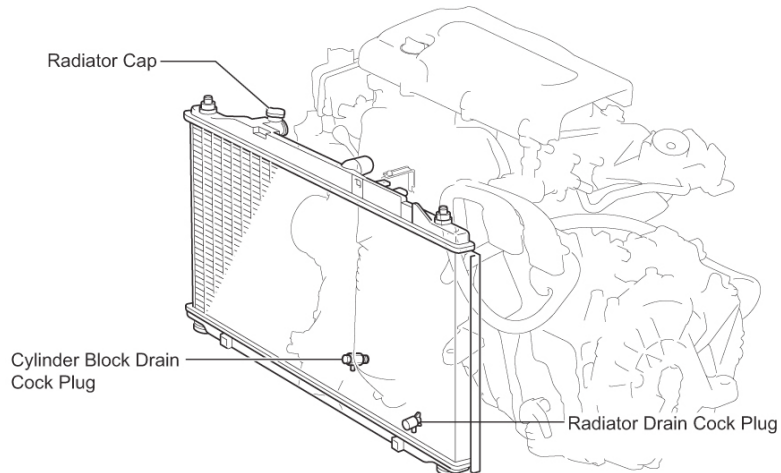

37. Locate the transaxle fluid filler and drain plugs and the inverter coolant drain plug.

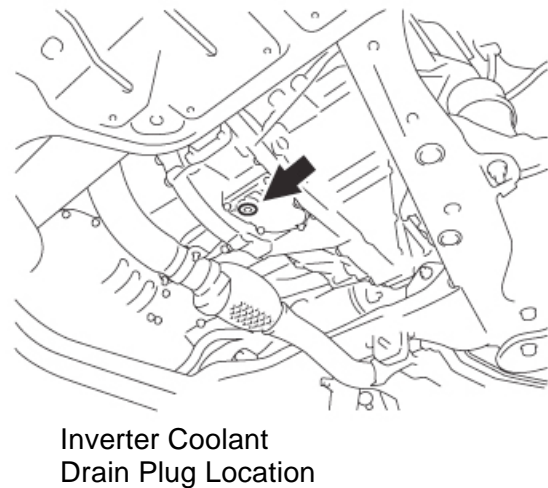
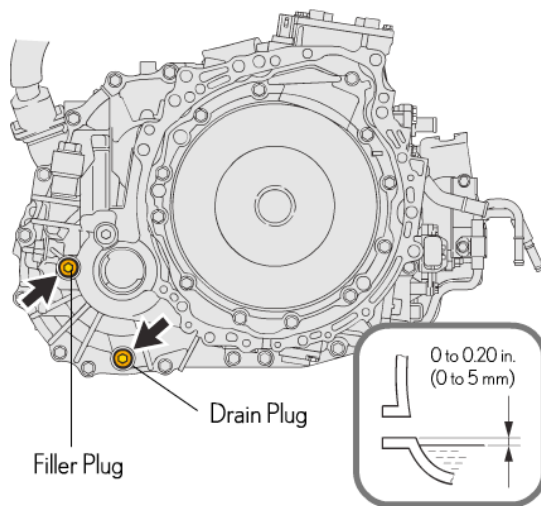

38. Return the vehicle to its original condition.

**Interior Walkaround**

39. Where is the air intake for the HV battery cooling system located on this vehicle?

---

40. Does this vehicle have a tire pressure monitor reset switch? If so, where is it located?

---

41. Name at least four screens that can be accessed through the large multi-display (navigation display).

---

---

---

42. Press the INFO button, then touch the Trip Information button on the screen. What information is displayed on the Fuel Consumption Screen?

---

---

---

43. Open the Energy Monitor screen and explore the available viewing options. What types of information are available?

---

---

---

**Inspection Mode**

44. Follow the steps in the 256 Technician Handbook to activate Inspection Mode.

45. How much time do you have to perform the procedure?

---

46. How can you confirm Inspection Mode is activated?

---

47. Is it okay to drive the vehicle while in Inspection Mode? Why or why not?

---

---

48. Make sure the vehicle is in Park, then hold the throttle to the floor. What does the engine do?

---

---

49. How is Inspection Mode cancelled?

---

---

50. Exit Inspection Mode and return the vehicle to its original condition.

51. When would you put the vehicle in Inspection Mode?

---

---