



# Open Educational Resources

Terra CREATE Project Team

Presented by:

Tom Wylie, Northwest State CC, Archbold, OH  
([twylie@northweststate.edu](mailto:twylie@northweststate.edu))



# What is OER?

1. Open Educational Resources
2. Free material that can be used for instruction
3. Some Faculty replace textbooks with OER
4. Some Faculty use OER in addition to the textbook
5. Most OER can be modified and reused
6. All materials funded through federal agencies (DOL, NSF, DOE) is considered OER and can be used based on the licensing



# What are Learning Objects

1. Passive Learning versus Active Learning
2. Active Learning Objects are: Video, Voice over PPT, & Simulations
3. Targeted Learning Objects are PDFs to focus on a topic area, or even a video on how to do something
4. Hands-on students learn best with videos or a simulations, but also learn with a targeted learning object
5. Study guides and quizzes/tests are learning object



# URLs Used in OER Workshop:

Engneertech.org: Eastern Iowa CC Videos on Technical Topics

<http://engineertech.org/>

Wisconsin Online Learning Object:

<https://www.wisc-online.com/>

The DOL document repository:

[www.skillscommons.org](http://www.skillscommons.org)

The NSF ATE document repository:

[www.atecentral.net](http://www.atecentral.net)

Jim Pytel, Big Bad Tech, Video Lectures with Graphics

<https://www.youtube.com/user/bigbadtech>

# Creative Commons Licensing

Creative Commons is a nonprofit organization that provides a licensing structure that allows individuals and organizations in the world, a free, simple, and standardized way to grant copyright permissions for creative and academic work.

Material is not registered at Creative Commons. The author chooses a license, then attaches it to the material, then puts it in a repository for open access.

## DOL DISCLAIMER:

This product was funded by a grant awarded by the U.S. Department of Labor's Employment and Training Administration. The product was created by the grantee and does not necessarily reflect the official position of the U.S. Department of Labor. The Department of Labor makes no guarantees, warranties, or assurances of any kind, express or implied, with respect to such information, including any information on linked sites and including, but not limited to, accuracy of the information or its completeness, timeliness, usefulness, adequacy, continued availability, or ownership.



**Attribution**

**CC BY**



This work is licensed under a [Creative Commons Attribution 4.0 International License](https://creativecommons.org/licenses/by/4.0/).

To learn more about each type of CC License, go to this link:

<https://creativecommons.org/licenses/>

# Copyright / Licensing

## Primary License:



This work is licensed under a [Creative Commons Attribution 4.0 International License](https://creativecommons.org/licenses/by/4.0/).

## Additional License(s):



This work is licensed under a [Creative Commons Attribution-ShareAlike 4.0 International License](https://creativecommons.org/licenses/by-sa/4.0/).



This work is licensed under a [Creative Commons Attribution-NonCommercial 4.0 International License](https://creativecommons.org/licenses/by-nc/4.0/).



This work is licensed under a [Creative Commons Attribution-NonCommercial-ShareAlike 4.0 International License](https://creativecommons.org/licenses/by-nc-sa/4.0/).



This work is free of known copyright restrictions.

To learn more about each type of CC License, go to this link:

<https://creativecommons.org/licenses/>



# Attribution 4.0 International (CC BY 4.0)

This is a human-readable summary of (and not a substitute for) the [license](#). [Disclaimer](#).

## You are free to:

**Share** — copy and redistribute the material in any medium or format

**Adapt** — remix, transform, and build upon the material for any purpose, even commercially.

The licensor cannot revoke these freedoms as long as you follow the license terms.



<https://creativecommons.org/licenses/by/4.0/>



# Under the following terms:



**Attribution** — You must give appropriate credit, provide a link to the license, and indicate if changes were made. You may do so in any reasonable manner, but not in any way that suggests the licensor endorses you or your use.

**No additional restrictions** — You may not apply legal terms or technological measures that legally restrict others from doing anything the license permits.







# Attribution: Giving Appropriate Credit

This document was originally created by Northwest State Community College through DOL funding with TAACCCT Round 4. The author and Creative Commons licensing can be found at the following link: <http://www.skillscommons.org/handle/taaccct/17746>. The original material was modified to meet the needs of Terra Community College.

## DOL DISCLAIMER:

This product was funded by a grant awarded by the U.S. Department of Labor's Employment and Training Administration. The product was created by the grantee and does not necessarily reflect the official position of the U.S. Department of Labor. The Department of Labor makes no guarantees, warranties, or assurances of any kind, express or implied, with respect to such information, including any information on linked sites and including, but not limited to, accuracy of the information or its completeness, timeliness, usefulness, adequacy, continued availability, or ownership.



This work is licensed under a [Creative Commons Attribution 4.0 International License](https://creativecommons.org/licenses/by/4.0/).





# All Creative Common Licenses:

**Remix:** means to add, delete, modify the original OER for reuse:

A **Commercial** license does allow a user to remix and modify, but they can also resell it.

**Non-Commercial** license does not allow a user to resell the OER, but they can still use it, modify it, and share it.

This link explains all the licenses:

<https://creativecommons.org/about/cclicenses/>

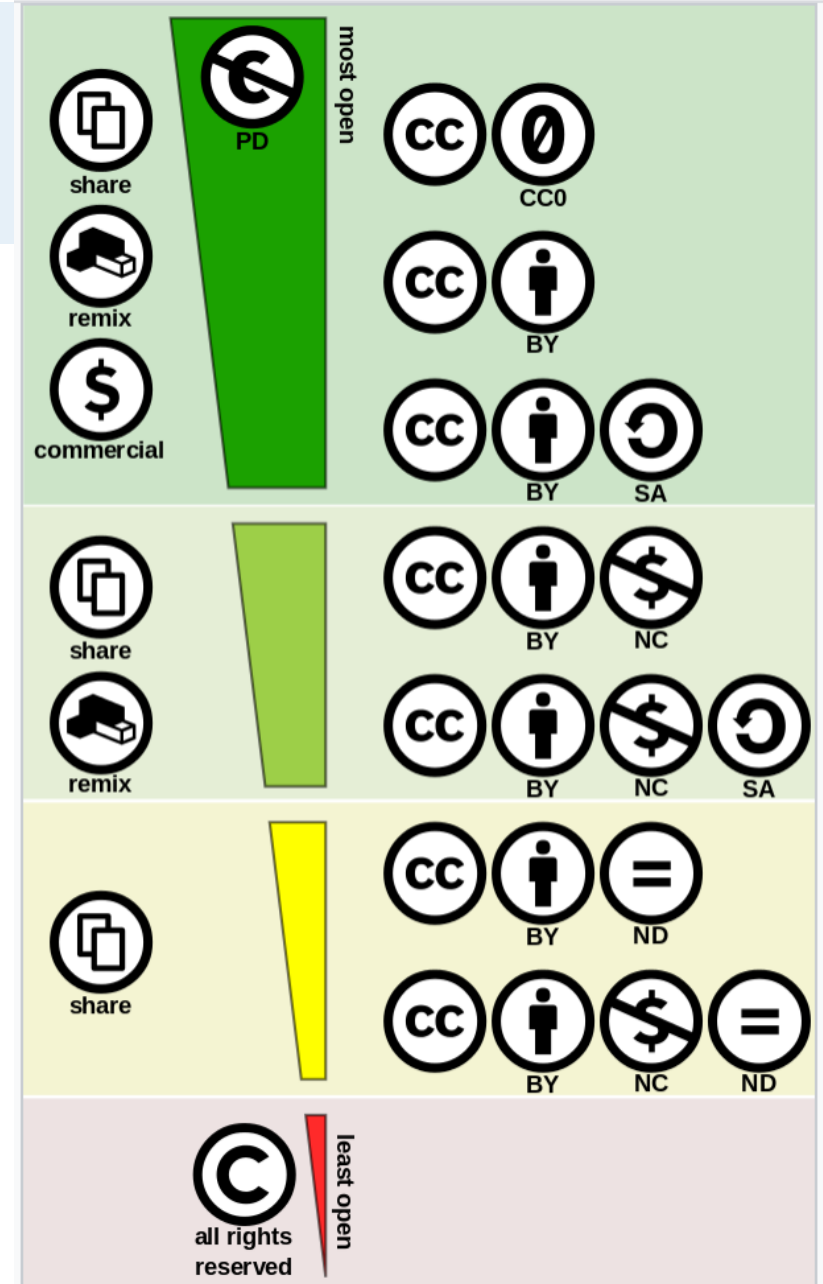

Creative commons license spectrum between public domain (top) and all rights reserved (bottom). Left side indicates the use-cases allowed, right side





# WiscOnline Licensing

## About

- The WiscOnline Story
- Our Mission
- The Team
- Learning Objects
- API

## Help

- Technical Support
- FAQ
- Accessibility Statement

## Contact/Follow

- Contact
- Translate Our Content
- Follow ▼

Terms of Use

Badges

Privacy Policy



Wisc-Online is a creation of Wisconsin's Technical Colleges and maintained by Fox Valley Technical College.

Wisc-Online by Fox Valley Technical College is licensed under a Creative Commons Attribution-NonCommercial 4.0 International License.





# Referencing Original Work in OER

## **Video: Piping and Instrumentation Diagrams**

[http://engineertech.org/courses/process-control/?submit=view&vimeography\\_gallery=46&vimeography\\_video=135569941](http://engineertech.org/courses/process-control/?submit=view&vimeography_gallery=46&vimeography_video=135569941)

This video was created by Eastern Iowa Community College in TAACCCT Round 2. The link to the licensing information can be found at:

<http://www.skillscommons.org/handle/taaccct/10039>

## **Simulation: Proportional Control Amplifier**

<https://www.wisc-online.com/learn/technical/industrial-automation/iau12008/proportional-control-amplifier>

This learning object is linked from Wisc-Online (Wisconsin-Online), a nonprofit educational website. Fox Valley Technical College maintains fiscal and operational responsibility for Wisc-Online with guidance from an advisory council that includes representation from all of the colleges in the Wisconsin Technical College System. For a link to the page with the Creative Commons licensing information, copy the following link into an internet browser:

<https://www.wisc-online.com/our-story>



# URLs Used in OER Workshop:

Engineertech.org: Eastern Iowa CC Videos on Technical Topics  
<http://engineertech.org/>

Wisconsin Online Learning Object:  
<https://www.wisc-online.com/>

The DOL document repository:  
[www.skillscommons.org](http://www.skillscommons.org)

The NSF ATE document repository:  
[www.atecentral.net](http://www.atecentral.net)

Jim Pytel, Big Bad Tech, Video Lectures with Graphics  
<https://www.youtube.com/user/bigbadtech>

# ENGINEERTECH.ORG:

ENGINEERTECH.ORG is a website created to house videos created by Eastern Iowa Community College with funds from TAACCCT Round 2 grant. This is the user interface to the videos that are housed at VIMEO.COM (instead of YouTube). A college LMS can link to each video. The MP4 videos can also be downloaded from Skillscommons. The link to the CC license can also be found at Skillscommons.

Not secure | engineertech.org

## ENGINEERING TECHNOLOGY

SIMULATIONS FOR LEARNING

# Engineering Technology

### Open Courseware & Educational Resources for Instructors & Students

Choose a Topic VIEW

- Choose a Topic
- AC Circuit Analysis
- Basic Math Topics
- DC Circuit Analysis
- Digital Circuits & Systems
- Electrical Motor Control & Power
- Fluid Power Control
- Fluid Power Design/Application
- Fluid Power Fundamentals
- Industrial Print Reading
- Industrial Robotics
- Lean Manufacturing
- Microcontrollers
- Motion Control
- Motors & Drives
- Physics Fundamentals

**FREE TO USE**

Each simulation can be embedded into your online courses or used in the classroom. Use, Modify, or Share for free under the Creative Commons license.

**ENGINEER FOCUSED**

Learning simulations covering Automation & Electrical & Motor Control, Process Control or Renewable Energy.

**Featured Simulati**

Northwest State Community College

NSI





# Piping and Instrumentation Diagrams

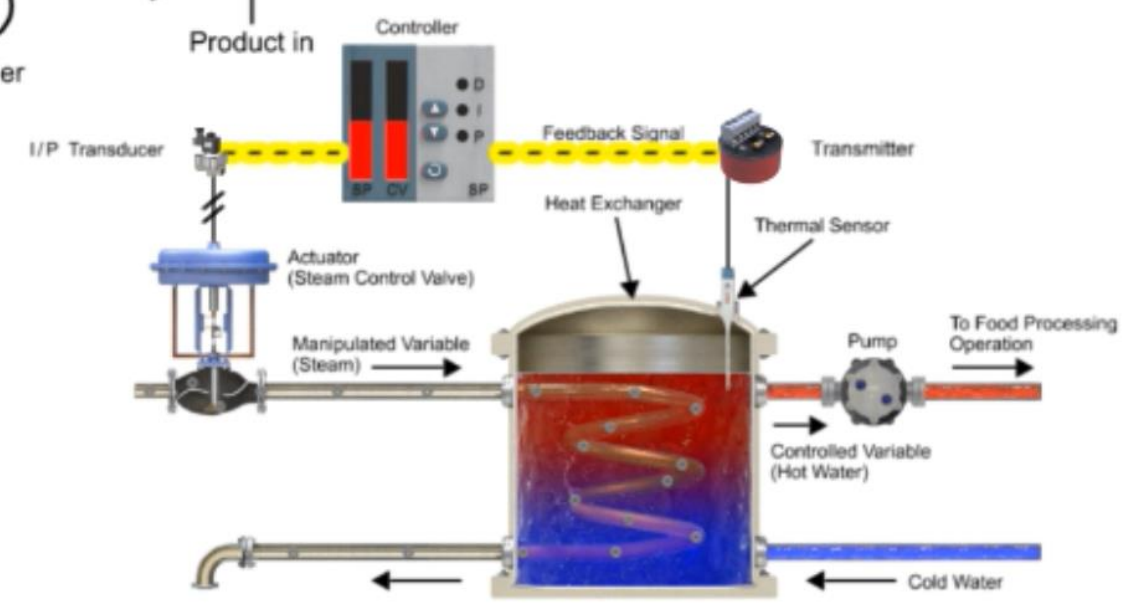
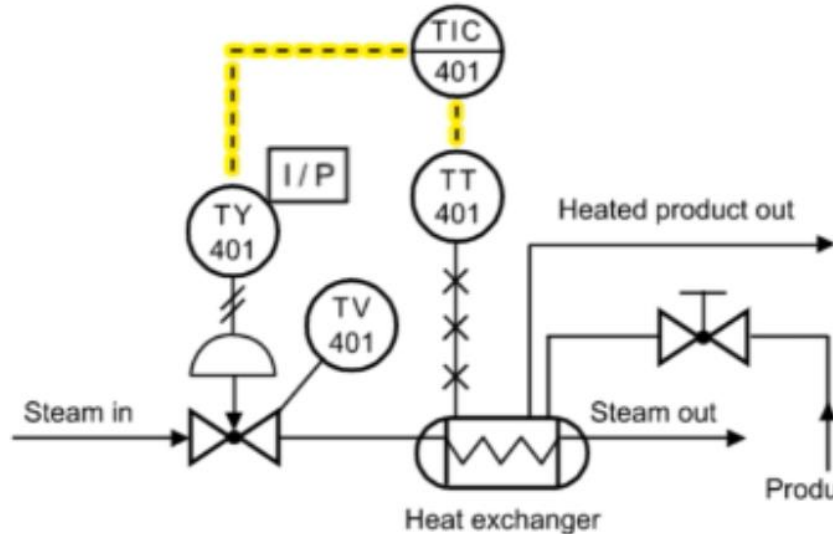

Download Embeddable Simulation with Interactive Quiz Questions:  
[bit.ly/1lspWI8](http://bit.ly/1lspWI8)







# URLs Used in OER Workshop:

Engneertech.org: Eastern Iowa CC Videos on Technical Topics

<http://engineertech.org/>

Wisconsin Online Learning Object:

<https://www.wisc-online.com/>

The DOL document repository:

[www.skillscommons.org](http://www.skillscommons.org)

The NSF ATE document repository:

[www.atecentral.net](http://www.atecentral.net)

Jim Pytel, Big Bad Tech, Video Lectures with Graphics

<https://www.youtube.com/user/bigbadtech>



# WISC-ONLINE:

WISC-ONLINE is an online repository for active learning objects that is accessible by going to their website: <https://www.wisc-online.com/>, and searching for a topic, or look into categories. These links can be posted in an LMS system for students to view on a computer or on their portable devices.

The screenshot displays the WISC-ONLINE website interface. On the left is a dark sidebar menu with categories: Computer Science, Manufacturing & Engineering, Electronics, Industrial Automation, Machine Tool, Welding, View All, Math, Science, Social Science, Wisc-Online Categories, WTCS Categories, and Basic Computer Skills Course. The main content area features a search filter bar with 'By Rating' selected, and a pagination indicator showing 'Displaying 0 - 25 of 306 results.' and 'Page 1 of 13'. Below the filter are eight learning object cards, each with a title, author, and engagement metrics (likes and views).

Title	Author	Likes	Views
Troubleshooting a Three Phase Motor that is Overheating	Excelsior College	419	721
Using Blueprints to Troubleshoot a Defective Compressor Motor	Excelsior College	243	234
Using Blueprints to Troubleshoot a Defective Water Pump	Excelsior College	222	536
Work and Power (Screenecast)	James Bourassa, John ...	204	638
PID Control (Screenecast)	Terry Bartelt	184	1,439
Identifying Lever Classes	James Bourassa	227	18.2k
Pneumatic Schematic Symbol Flashcards	Terry Bartelt	208	11.8k
P&ID Tag Numbers	Terry Bartelt	216	26.2k



# WISC-ONLINE:



Operational | Business | Tools



# WISC-ONLINE:

## Stop-Button Wiring to a PLC

Page 3 of 18

Using a Normally Closed Switch and an Examine-Off Contact

There is a common mistake made by PLC programming beginners. They incorrectly wire a normally closed pushbutton to perform the stop function, and then program an Examine-Off contact on the PLC ladder diagram that corresponds to the pushbutton.

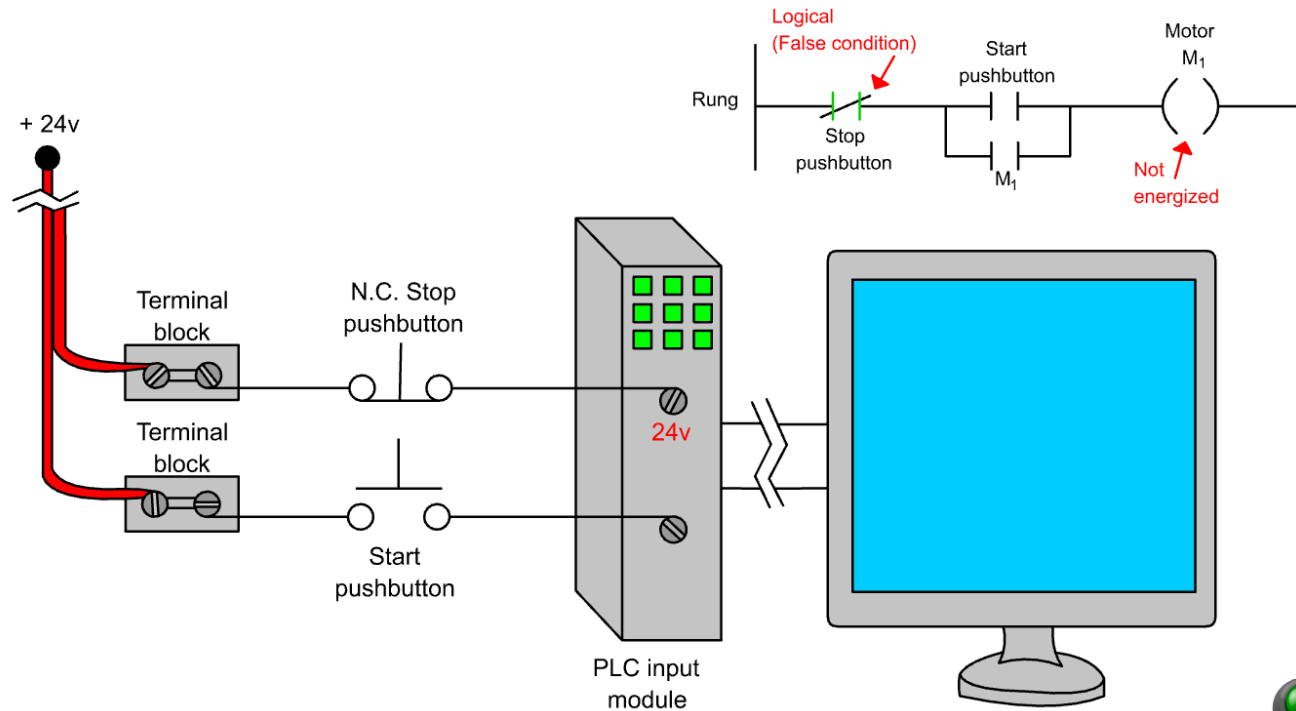

# WISC-ONLINE:



## Calculating Horsepower, RPM & Torque

Page 15 of 17

Narration

### Horsepower Calculation Problems

Calculate  
Horsepower

Torque

2352.9 ft-oz

RPM

198

Horsepower

Round to the tenth  
decimal place.

Reference  
Window

Check  
Answer



< BACK

NEXT >



# URLs Used in OER Workshop:

Engneertech.org: Eastern Iowa CC Videos on Technical Topics

<http://engineertech.org/>

Wisconsin Online Learning Object:

<https://www.wisc-online.com/>

The DOL document repository:

[www.skillscommons.org](http://www.skillscommons.org)

The NSF ATE document repository:

[www.atecentral.net](http://www.atecentral.net)

Jim Pytel, Big Bad Tech, Video Lectures with Graphics

<https://www.youtube.com/user/bigbadtech>





# SKILLSCOMMONS.ORG:

SKILLSCOMMONS.ORG is a website created to house the instructional content that was developed with DOL dollars, especially materials developed in the TAACCCT grant project. There are thousands of learning objects that are stored there. A person can spend hours searching within their site. A search can be done on a person, college or technical content topic. All of the licensing information is stored with the object.

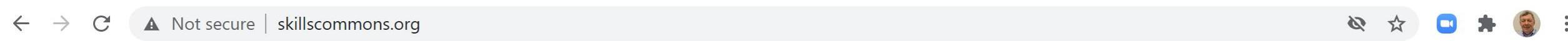

- ABOUT +
- BROWSE +
- SHOWCASES
- PARTNER WITH US +
- CONTACT
- LOGIN

## Workforce Development Digital Library

FREE and OPEN Workforce Training Materials for 21st Century Employment

  
[Browse by industry, credentials & material type](#) | [Advanced search](#)

Eastern Iowa Community College



EEM162

electrical safety

Eastern Iowa Community College

EEM221

These MP4 videos can be uploaded to an LMS system, or could be put on YouTube.

Some colleges are loading MP4s into the LMS, stored on their own servers so they can monitor when a student opens the learning object, and to assure that only their registered students can get to it.

These MP4s can also be edited in Camtasia to add or move content.

All the videos Eastern Iowa Community College has at ENGINEERTECH.ORG, housed by VIMEO, is stored as MP4s in Skillscommons.

#### Material Type

- Syllabus (2637)
- Recruitment and Outreach (1551)
- Hybrid/Blended Course (1343)
- Presentation (1314)
- Grant Management Materials (1246)
- Collection (1214)
- Student Support Materials (1125)
- Assignment (1121)
- Reference Material (1096)
- Instructor and/or Advisor/Case Manager Support Materials (846)
- ... View More

#### Credential Type

- Certificate (6496)
- Associate Degree (5885)
- Stacked/Latticed Credential Model (2900)
- None (2284)
- Credential (1563)
- Other (1051)
- Diploma (982)
- Bachelors Degree (325)
- III (5)

**Timer Functions On/Off Delays in PLCs** preview

Simulation

Eastern Iowa Community College

This narrated animation illustrates timer functions on/off delays in PLCs.

**NPN Transistors** preview

Simulation

Eastern Iowa Community College

This narrated animation illustrates the operation and functions of NPN transistors.

**Pressure Relief Valves** preview

Simulation

Eastern Iowa Community College

This narrated animation illustrates the principles and operations of pressure relief valves.

**Hydrostatic Pressure in Process Control** preview

Simulation

Eastern Iowa Community College

This narrated animation illustrates hydrostatic pressure issues in process control.

**The Law of Gravity - Fundamental Physics** preview

Simulation

Eastern Iowa Community College

This narrated animation illustrates the Law of Gravity.



[Link to video in EngineerTech.org](#)

# Piping and Instrumentation

Hunter, Tim

This narrated animation illustrates piping and instrumentation associated with process control.

Raw MP4 that can be edited

## Copyright / Licensing

Creative Commons License

Primary License:



This work is licensed under a Creative Commons Attribution 4.0 International License.

[This narrated animation describes the principles associated with Piping and Instrumentation associated with Process Control.](#) (8 MB)

[This guide describes how to reach the 508 accessibility transcript and how to include the power concept into one's courseware.](#) (1 MB)

Did you download this item? We value your feedback, and it'll only take a minute

Hide Statistical Information

Total hits all time



### Additional Public Access To Materials:

<http://www.engineertech.org/>

Website for links to all of the Eastern Iowa CC videos



The user can search by the Author of the materials in Skillscommons, or the organization, or the topic area.



[Advanced search](#)

Results **1-10** of **46**

sort by: **relevance** | [newest f](#)

Has preview



Industry

- [Manufacturing -- Miscellaneous Manufacturing \(339\) \(14\)](#)
- [Developmental Education \(6\)](#)
- [Manufacturing -- Plastics and Rubber Products Manufacturing \(326\) \(6\)](#)
- [Information Technology -- Computer Operating Systems \(Programming\), Digital Forensics, Cyber Security, Network Security, IT Security \(51\) \(3\)](#)
- [Manufacturing -- Miscellaneous Manufacturing -- Other Miscellaneous Manufacturing \(3399\) \(3\)](#)
- [Administrative and Support and Waste Management and Remediation Services -- Waste Management and Remediation Services](#)

### Servo and Robotics

Hybrid/Blended Course

**Northeast State Community College**

Servo/Robotics Systems is an introductory Hybrid course in industrial robotics with emphasis on the Fanuc R-J30iA series robot controller. The course is intended for students who wish to gain insight into robot operations in order to program, test, run, and trouble-shoot FANUC material handling appl . . .

### Industrial Electricity II

Hybrid/Blended Course

**Northwest State Community College**

The purpose of this course is to develop the student's knowledge and skills in the area of electrical safety, DC/AC machines and basic control circuits. The electrical safety module will focus on lockout/tagout, arc-flash standards, PPE, electrical panels and overcurrent protection. The DC/AC machin . . .

### Industrial Wiring

Hybrid/Blended Course

**Northwest State Community College**

industrial safety



Browse by [industry](#), [credentials](#) & [material type](#) | [Advanced search](#)



## Industry

- Manufacturing -- Miscellaneous Manufacturing (339) (472)
- Developmental Education (460)
- Information Technology -- Computer Operating Systems (Programming), Digital Forensics, Cyber Security, Network Security, IT Security (51) (328)
- Health Care and Social Assistance (62) (241)
- Professional, Scientific, and Technical Services (54) (207)
- Professional, Scientific, and Technical Services -- Professional, Scientific, and Technical Services (541) (202)
- Manufacturing -- Fabricated Metal Product Manufacturing (332) (138)
- Mining, Quarrying, and Oil and Gas Extraction - - Oil and Gas Extraction -- Oil and Gas Extraction (2111) (137)
- Manufacturing -- Miscellaneous Manufacturing -- Other Miscellaneous Manufacturing (3399) (132)
- Construction (23) (125)
- ... View More

In this example the user can search for any topic on Industrial Safety.

### Machine Shop Safety Challenge Test

#### Student Support Materials

#### Front Range Community College

Challenge test for machine shop safety

### Ohio TechNet SAFE 145 Safety in General Industry

#### Other

#### Lorain County Community College

These are course materials for OSHA Safety in General Industry 30 Hour

### EIC 103 Safety & Industry Certificate

#### Hybrid/Blended Course

#### Trinidad State Junior College

This course cartridge contains material to teach EIC 103 Safety & Industry Certificate including materials for a comprehensive review of electrical industry safety standards. When applicable, the student will earn a permit and/or certification in the following areas: CDL Licensing, First Aid/CPR/AED . . .

### Ohio TechNet LCCC\_Safety

#### Recruitment and Outreach

#### Lorain County Community College

These are outreach materials for the LCCC Safety program and courses, and one LCCC Curriculum Guide for the 2 year Associate Degree.

### Industrial Safety Syllabus

#### Syllabus

# Programmable Controls I

Wylie, Tom

1

The course is a study of the installation, programming and troubleshooting of programmable controlled systems currently used in an industrial environment. The focus will be on Installation, Programming, Engineering and Maintenance tasks performed with PLC systems. The primary PLC used for this class will be the Allen Bradley SLC-500 and CompactLogix, using RSLogix 500, RSLogix5000 and RSLinx software. The topics presented will be learned through Online instructional material, and hands on labs. After completing this course the student will: 1. Explain the function of a PLC in an industrial environment 2. Set up communications between a PLC and a programming panel 3. Configure and program an Allen Bradley SLC-500 system. 4. Install and maintain basic control system based on the SLC-500 5. Troubleshoot an Allen Bradley SLC-500 system. 6. Program an Allen Bradley CompactLogix with RSLogix5000 7. Maintain and troubleshoot an Allen Bradley CompactLogix system 8. Interpret AB PLC-5 hardware addressing & block transfer instructions

# ZIPPED Files in Skillcommons.org

Many objects (files) are zipped within Skills Commons, thus they can be retrieved easily and added to a course within your unique LMS. NSCC objects are all in their native format: Word, PPT, MP4.

- Name
- Module One (17 MB)
- Module Two (7 MB) 2
- Module Three (7 MB)
- Module Four (4 MB)
- Module Five (3 MB)
- Module Six (10 MB)
- Module Seven (583 KB)

- 3 PLC200 M2 (1).zip
- open-pro240-process-troubleshooting-export (1) (1).imsc
- 17\_1212\_+QM+Alignment+-+IND-121+lite+version+latest+version.docm
- open-pro100-intro-to-process-technology-export (2).imsc

A screenshot of a file context menu for 'PLC200 M2 (1).zip'. The menu is open, showing options like 'Open with WinZip', 'Print file list', 'Scan with Windows Defender...', 'Share', 'Open with', 'Give access to', 'WinZip', 'Restore previous versions', 'Send to', and 'Cut'. The 'Open with' submenu is expanded, showing 'Google Chrome', 'Windows Explorer', and 'WinZip'. A red circle with the number '4' is placed over the 'WinZip' option.

- Name
- 5
- 21\_PLC200 Module 2 Learning Sequence Sheet 010617.docx
- 22a\_PLC200 Module 2 Information on RSLinx and RSLogix500.pptx
- 22b\_PLC200 Module 2 Intro to Virtual Machines.pptx
- 23\_PLC200 Module 2 KAA Study Guide.docx
- 24\_PLC200 Module 2 Practice Quiz.docx
- 25a\_PLC200\_Lab03\_SLC-500 Getting Started with RSLogix500 Lab M2.docx
- 25b\_PLC200\_Lab04\_SLC-500 Relay Instructions Lab M2.doc



# Common Cartridge Files found on Skills Commons

## PRO240 Industrial Troubleshooting

This course Provides instruction in the different types of troubleshooting techniques, procedures, and methods used to solve process problems. Topics include application of data collection and analysis, cause-effect relationships, and reasoning.

 Course description and competencies (131 KB)

 Course material imsc file that can be imported to an LMS using a standard import or changed to a zipped file command or opened/viewed with a zipped file application. (2 MB)

Did you download this item? We value your feedback, and it'll only take a minute

**Date:**

2014-07-01

**Primary Material Type:**

[skillscommons.org/bitstream/handle/taaccct/2712/open-pro240-proce...](https://skillscommons.org/bitstream/handle/taaccct/2712/open-pro240-proce...)

open-pro240-pr....imsc 

Some authors do not want to license all of their objects, so they export their online course with all of the object as a “.imsc” type of file. This way they can license only the online course. The .imsc file can be imported into the LMS.

A Canvas exported courses (as a .imsc file can import into Canvas at another institution, but some objects are removed if imported into Blackboard or Sakai.



# Some of my Favorites on Skills Commons Site

[MTE247 Strength of Materials Course Pikes Peak CC](#)

<http://www.skillscommons.org/handle/taaccct/3914>

[EEM151 Motors and Controls I, Midlands CC, SC](#)

<http://www.skillscommons.org/handle/taaccct/741>

[OPT1100 Tooling & Machining Metrology, Stark State College, OH](#)

<http://www.skillscommons.org/handle/taaccct/16107>

[Mechanical Components, Purdue University Northwest, IN](#)

<http://www.skillscommons.org/handle/taaccct/10929>

[Introduction to Electrical Circuit Simulation, Colorado Mountain College, CO](#)

<http://www.skillscommons.org/handle/taaccct/18698>





# URLs Used in OER Workshop:

Engneertech.org: Eastern Iowa CC Videos on Technical Topics

<http://engineertech.org/>

Wisconsin Online Learning Object:

<https://www.wisc-online.com/>

The DOL document repository:

[www.skillscommons.org](http://www.skillscommons.org)

The NSF ATE document repository:

[www.atecentral.net](http://www.atecentral.net)

Jim Pytel, Big Bad Tech, Video Lectures with Graphics

<https://www.youtube.com/user/bigbadtech>

# ATECENTRAL.NET:



ATECentral.net is a website that houses all the information about NSF Projects and NSF Centers throughout the nation. It also holds all of the resources that were developed with NSF funds.

### What is ATE?

With an emphasis on two-year colleges, the National Science Foundation's ATE (Advanced Technological Education) program focuses on the education of technicians for the high-technology fields that drive our nation's economy.

[Learn More About ATE](#)

[ATE Central Tools & Services](#)

### ATE Centers and Projects

All Active Inactive New All Centers Projects

All Mfg Ag/Env Bio/Chem Eng Gen Info Nano

### You are logged in.

Welcome, twylie

- [Your Microsite](#) Add
- [Preferences](#) Edit
- [Log Out](#)

### ATE Events

- 6** Photonics West Mar 6
- 7** ABRF Annual Meeting Mar 7
- 10** Food & Agriculture Mar 10
- 10** Seminar w/ Xinwei Wang

### What Can ATE Central Do for Me?

### Folder

Main Folder Edit

There are no resources in this folder.

### Toolbox

Recent Searches







# ATECENTRAL.NET:

If the user clicks on the “All” option on the map (shown by the red arrow), it will display all of the active NSF ATE Projects and Centers within the country. The user can click on any of the pins, and it will show the name of the award, as shown below.

# ATECENTRAL.NET:

Click on Resources, then choose ATE Resource Collection. The user can choose any of the categories at the bottom of the page.

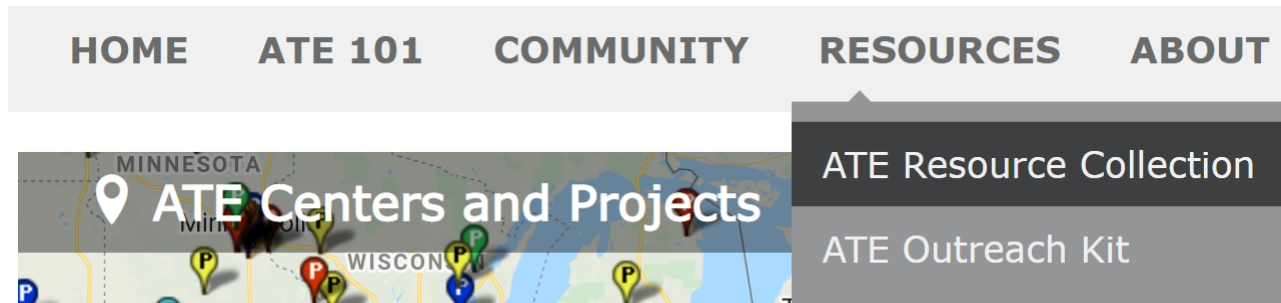

## Browse Resources

The ATE Central resource collection and archive contain curriculum, professional development materials, videos and other valuable resources created and collected by the ATE community. Browse the resource collection using the categories listed below, or search for ATE resources via the box at upper right.

7 classifications found.

- **Browse by:**
- **Education Level**
- **Format**
- **GEM Subject**
- **Resource Type**

[Advanced Manufacturing Technologies](#) 623

[Agricultural and Environmental Technologies](#) 858

[Bio and Chemical Technologies](#) 575

[Engineering Technologies](#) 1,473

[General Advanced Technological Education](#) 995

[Information and Security Technologies](#) 816

[Micro and Nanotechnologies](#) 388

# ATECENTRAL.NET:



<http://tijj.org/issues/issues/winter09/Winter09/cheng.pdf>



## **Industrial Automation Tutorials**

Presented on behalf of Galil, these videos, presented by "industry leader" Jacob Tal, provide compensation, piezo-ceramic actuators, microstepping, and more. These two-minute videos address common motion and I/O problems such as connecting to a Galil controller, PID temperature control, and more.

<http://www.galil.com/learn/online-videos>



## **Mechatronics Certification**

This four-page document demonstrates how the College of Lake County (CLC) Mechatronics Systems Certification Program, Level 1 Mechatronics Systems Assistant and Level 2 Mechatronics Systems Assistant, in partnership with the Florida Advanced Technological Education Center (FLATE), includes a short introduction to the program.



## **Hydraulics & Pneumatics**

This site, created by Penton, is the leading international technical magazine of fluid power. It covers fluid power technology, through both technology articles and application stories. Emphasis is on fluid-powered machines and the plant engineer who maintains them. Also included in the site are news, product information, and more.

<https://www.hydraulicspneumatics.com>



## **PRDE 2420 - Capstone Project Syllabus**

This is a syllabus for a four credit course offered at Macomb Community College that integrates problem solving, time and team management, and process changes. Upon completion of this course, students will be able to (1) present ideas in a team environment and (2) utilize research to solve a problem.



## **Emergency Preparedness Management: Occupational Profile**

This document, created by Eastern Iowa Community Colleges, serves as an overview of job management. What does emergency preparedness management involve? As the document explains, it is the application and coordination of a process that brings resources together to prepare, respond to, and recover from an emergency.



# URLs Used in OER Workshop:

Engneertech.org: Eastern Iowa CC Videos on Technical Topics

<http://engineertech.org/>

Wisconsin Online Learning Object:

<https://www.wisc-online.com/>

The DOL document repository:

[www.skillscommons.org](http://www.skillscommons.org)

The NSF ATE document repository:

[www.atecentral.net](http://www.atecentral.net)

Jim Pytel, Big Bad Tech, Video Lectures with Graphics

<https://www.youtube.com/user/bigbadtech>





# Jim Pytel YouTube Channel:

youtube.com/watch?v=XfcM4WhJmJc



jim pytel



Motor Nameplates (Full Lecture)

3,008 views • May 14, 2021

103 0 SHARE SAVE ...



**Jim Pytel**  
70K subscribers

SUBSCRIBE

In this lesson we'll learn to interpret important manufacturer, electrical, and mechanical information





# Jim Pytel YouTube Channel:



jim pytel

Manufacturer  
Model  
Serial Number

**Electrical Characteristics**

- Phase
- Frequency
-  Voltage
- Current
- Power Factor
- Efficiency
- Inrush Code
- Connection Diagrams

**Mechanical Characteristics:**

- Rated Power
- Rated Speed
- Design Code
- Frame
- Enclosure
- Insulation Class
- Temperature Data
- Duty Cycle





# How-To Videos for Session 1:

YouTube Video: T. Wylie, Video on Finding OER Videos and Simulations 042221

<https://youtu.be/uo934NaFoxs>

YouTube Video: T. Wylie, Video Searching for OER in Skillscommons 042221

<https://youtu.be/ep4Erjg46bs>



# The End of the Presentation

Please email the presenter with  
Any questions you may have, as  
well as any feedback on the session  
([twylie@northweststate.edu](mailto:twylie@northweststate.edu))